

**BIXOLON®**

# Wi-Fi Connection Manual **MOBILE PRITNER**

---

Ver. 1.00  
**XM7-40**

<http://www.bixolon.com>

## Table of Contents

<b>1. Manual Information</b> .....	<b>3</b>
<b>2. Precautions</b> .....	<b>3</b>
<b>3. How to Connect</b> .....	<b>4</b>
3-1 Android Soft AP mode (default) .....	6
3-2 iOS Soft AP mode (default) .....	7
3-3 How to change infrastructure mode .....	7
<b>4. Factory Reset</b> .....	<b>9</b>

## **1. Manual Information**

This WLAN manual provides information on the connection of wireless network with the mobile printer.

We at BIXOLON maintain ongoing efforts to enhance and upgrade the functions and quality of all our products. In following, product specifications and/or user manual content may be changed without prior notice.

## **2. Precautions**

2-1 The printer has to be within 100m(Out door) from AP(Access point) to connect WLAN. Although 35m is able to communicate in door, WLAN could be affected by environment to be shorten.

The printer's LCD shows the connection status of the wireless LAN.



- Indicates that the wireless LAN is connected normally



- Indicates that the WLAN password is wrong



- Indicates that the AP of the set SSID is not nearby

2-2 The maximum separating distance may be shortened if transmission obstacles, such as cement walls, are present

2-3 If a device (such as a microwave oven, wireless LAN, etc.) that uses the same frequency is present, transmission may be interrupted. Separate the printer and Bluetooth-enabled device from such interrupting devices by a distance of at least 5m.

### **3. How to Connect**

WLAN can be configured through the printer's WLAN interface. Likewise, WLAN can also be configured through the printer's Serial/USB interfaces.

#### **(1) Connecting Printer**

##### **1) Serial / USB cable**

Connect Serial/USB cable to Printer, PC device.

When Serial cable use, baudrate between Device and printer should be the same.

##### **2) WLAN**

Connect to the AP (Access Point) configured in Infrastructure mode in order to connect to the LAN/wireless network

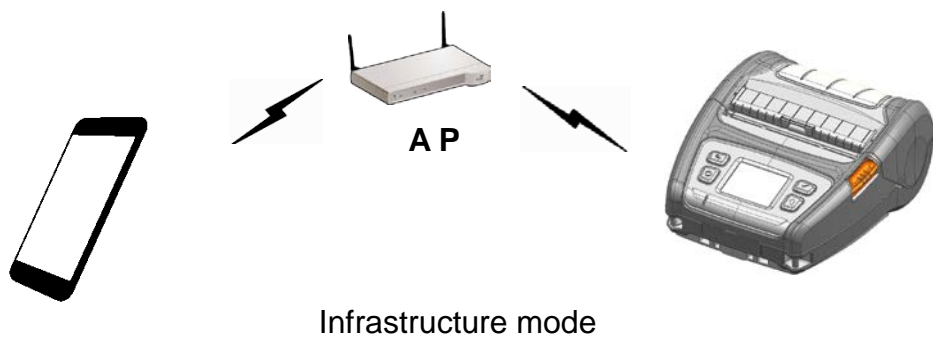

In order to configure the network between the wireless host device and the printer, set the printer to Soft AP Mode.

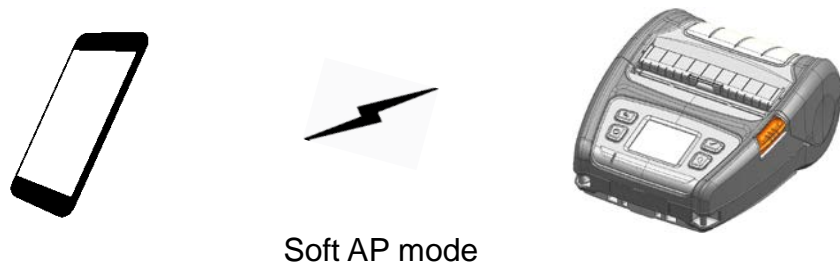

(2) Checking Network Setting

Self-test

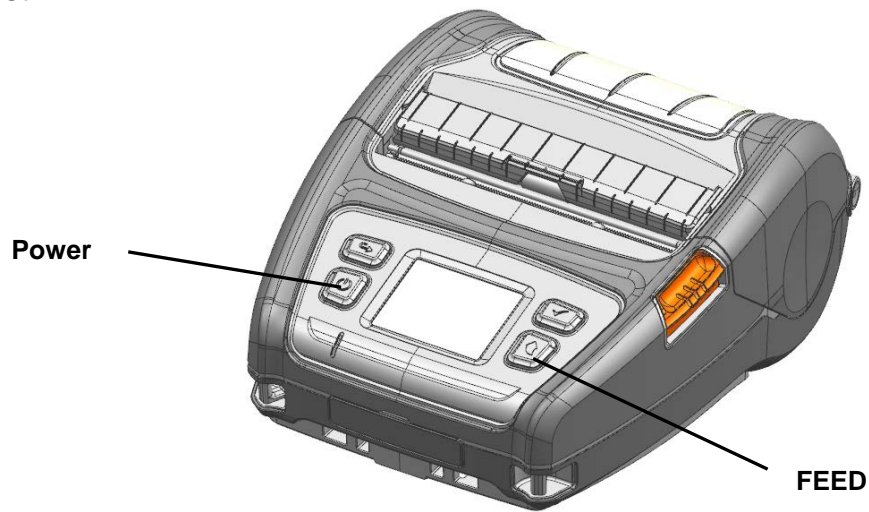

While the printer is turned off, turn on the printer while pressing the feed button. The printer setting values will then be printed.

## 3-1 Android Soft AP mode (default)

1) Select "Wi-Fi".

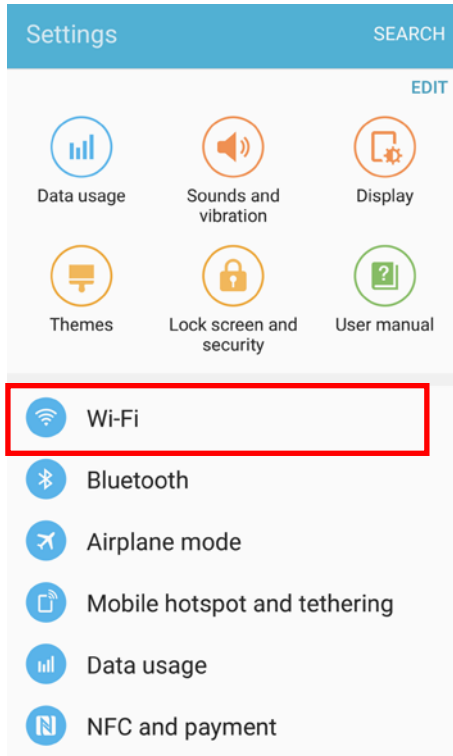

2) Select the printer to connect

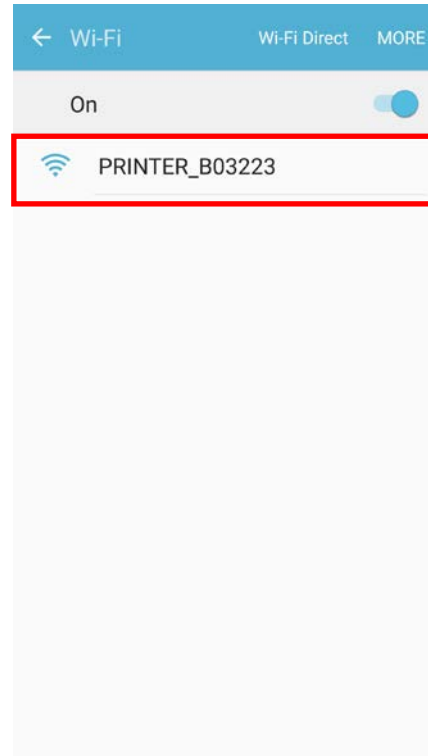

3) Select "CONNECT".

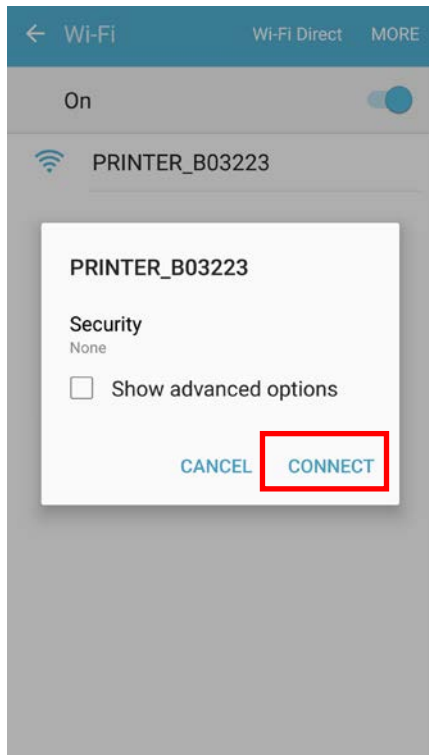

4) Wi-Fi communication is available.

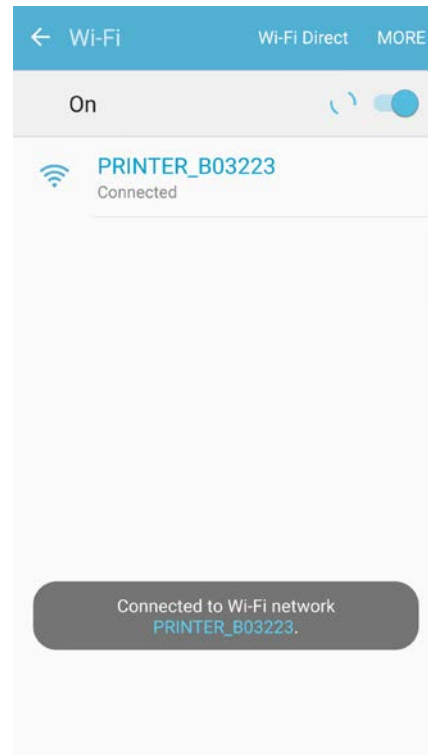

## 3-2 iOS Soft AP mode (default)

1) Select "Wi-Fi".

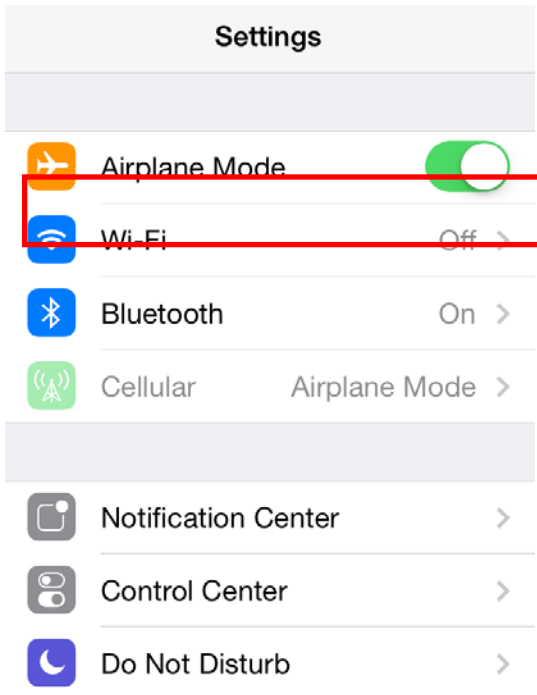

2) Wi-Fi ON and Select the printer to connect

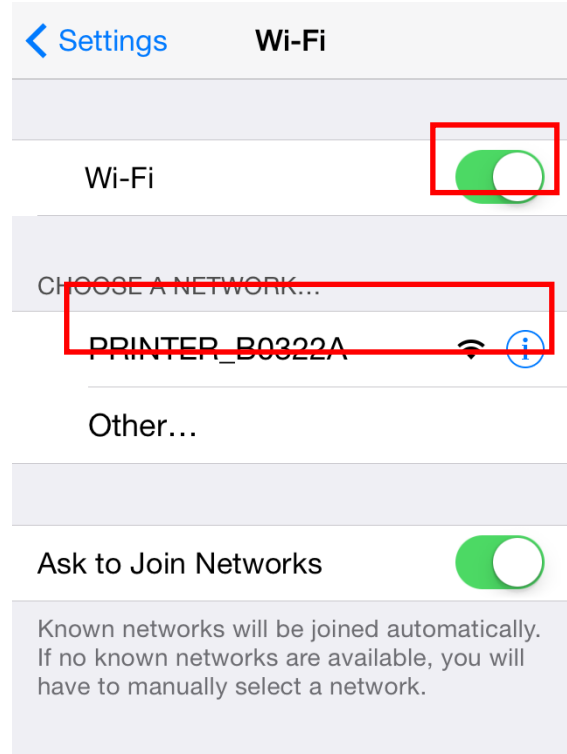

3) Wi-Fi communication is available



## 3-3 How to change infrastructure mode

1) Enter the IP address of the printer in the address bar, and the following login window will pop up. Enter the ID and Password set for the printer, and then click [LOG IN] (Default User Name: admin, Password: password)



2) Select “Wireless” to change Wi-Fi mode.

The screenshot shows a web interface for system configuration. On the left is a vertical navigation menu with items: System, **Wireless** (highlighted with a red box), Network, Traffic, Security, and Etc. The main content area is titled "System" and contains a table of configuration fields:

Firmware	39.30
MAC Address	00:15:94:b0:32:23
Operation Mode	AP
SSID	PRINTER_B03223
Channel	6 [2437 MHz]
IP Address	192.168.1.1
Subnet Mask	255.255.255.0
Gateway	192.168.1.2

3) Select “infrastructure”, and set SSID, WLAN Security Type.

The screenshot shows the "Wireless" configuration page. The left navigation menu has "Wireless" selected. The main content area is titled "Wireless" and contains the following configuration fields:

Connection Type	Infrastructure
SSID	TEST_AP
WLAN Security Type	Open

Below the "WLAN Security Type" field, there is a checkbox for "Enterprise" which is unchecked. A warning message reads: "If you try connect, this connection will be disconnected." At the bottom right, there is a "Save" button.



4) Reboot the Printer.

## **4. Factory Reset**

This function changes the WLAN settings of the printer to the initial factory settings.

### **Method**

Select the wireless interface on the printer's LCD screen.

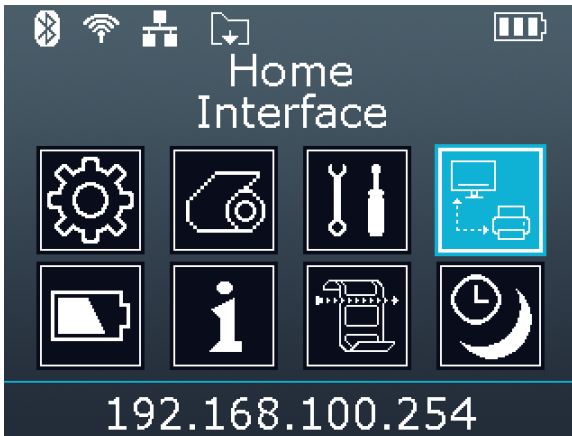

WLAN Factory reset is available in Interface > WLAN > WLAN Factory Reset  
 When the printer is turned off, the wireless LAN setting is applied as the factory default

**Factory Reset Values**

System	Printer Name	*Printer model
	Printer Port Num	9100
	User ID	admin
	User Password	password
Enc / Auth	Encryption	None/Open
Network	Network Mode	Soft AP mode
	SSID	PRINTER_{MAC address}
	Inactivity time	10
	IP Assignment Method	Manual (DHCP server)
	IP, Subnet, Gateway	IP : 192.168.1.1 Subnet : 255.255.255.0 Gateway : 192.168.1.2

**Specification**

Feature	Implementation
Operation Mode	Infrastructure, Soft AP, Ad-hoc, Wi-Fi Direct
Wireless Standard	IEEE 802.11a/b/g/n
Range	Up to 100m free space (Outdoor)
Security	WEP64/128
	WPA1/2 – PSK
	WPA 1/2 – Enterprise (EAP-TLS, EAP-TTLS, PEAP, LEAP, EAP-FAST)
Management	WLAN Configuration tool, HTTP, Smart connection APP

# Copyright

© BIXOLON Co., Ltd. All rights reserved.

This user manual and all property of the product are protected under copyright law. It is strictly prohibited to copy, store, and transmit the whole or any part of the manual and any property of the product without the prior written approval of BIXOLON Co., Ltd. The information contained herein is designed only for use with this BIXOLON product. BIXOLON is not responsible for any direct or indirect damages, arising from or related to use of this information.

- The BIXOLON logo is the registered trademark of BIXOLON Co., Ltd.
- All other brand or product names are trademarks of their respective companies or organizations.

BIXOLON Co., Ltd. maintains ongoing efforts to enhance and upgrade the functions and quality of all our products.

In the following, product specifications and/or user manual content may be changed without prior notice.

# Caution

Some semiconductor devices are easily damaged by static electricity. You should turn the printer "OFF", before you connect or remove the cables on the rear side, in order to guard the printer against the static electricity. If the printer is damaged by the static electricity, you should turn the printer "OFF".