

BIXOLON®

User's Manual

SRP-380/382plus

THERMAL RECEIPT PRINTER

Ver. 1.00



www.bixolon.com

Copyright

© BIXOLON Co., Ltd. All rights reserved.

This user manual and all property of the product are protected under copyright law. It is strictly prohibited to copy, store, and transmit the whole or any part of the manual and any property of the product without the prior written approval of BIXOLON Co., Ltd. The information contained herein is designed only for use with this BIXOLON product. BIXOLON is not responsible for any direct or indirect damages, arising from or related to use of this information.

- The BIXOLON logo is the registered trademark of BIXOLON Co., Ltd.
- All other brand or product names are trademarks of their respective companies or organizations.

BIXOLON maintains ongoing efforts to enhance and upgrade the functions and quality of all our products.

In the following, product specifications and/or user manual content may be changed without prior notice.

Caution

Electronics, such as printers, are prone to damage by static electricity. Therefore, to protect the printer from static electricity, be sure to turn off the printer before connecting or disconnecting the cable to the rear of the printer. If the printer is damaged by static electricity, contact your local dealer.

This equipment is not suitable for use in locations where children are likely to be present. When the printer is operating with the media cover open, do not wear anything that can touch the drive, such as clothing, necklaces, rings, watches, or employee certificates close to it. Also, keep yourself away from the printer as it is dangerous for some parts of the body to come into contact with it. If an object or part of your body touches the drive, immediately disconnect the power cord or turn off the power switch on the back of the product.

Warning

Hazardous moving parts
Keep fingers and other body parts away
Pull the print head lever can be stop all moving parts.



IEC 60417-6057 (2011-05) for other moving parts.

Mise en garde

Les appareils électroniques, tels que les imprimantes, risquent d'être endommagés par l'électricité statique. Par conséquent, pour protéger l'imprimante de l'électricité statique, veuillez à l'éteindre avant de connecter ou de déconnecter le câble situé à l'arrière de celle-ci. Si l'imprimante est endommagée par l'électricité statique, contactez votre revendeur local

Cet appareil n'est pas adapté d'utiliser dans des endroits où des enfants sont probablement d'être présents.

Lorsque l'imprimante fonctionne avec le capot ouvert, ne portez rien qui puisse entrer en contact avec le mécanisme, tel que des vêtements, des colliers, des bagues, des montres ou des certificats d'employé à proximité. Éloignez-vous également de l'imprimante car il est dangereux que certaines parties du corps entrent en contact avec celle-ci. Si un objet ou une partie de votre corps entre en contact avec le mécanisme, débranchez immédiatement le câble d'alimentation ou éteignez l'interrupteur situé à l'arrière du produit.

Attention

Pièces mobiles dangereuses
Veuillez à ce que vos doigts ou toute partie du corps n'entre(nt) pas en contact avec ces pièces. Tirez le levier de la tête d'impression pour arrêter toutes les pièces en mouvement.



IEC 60417-6057 (2011-05) pour les autres pièces mobiles.

Compliance information

This device complies with Part 15 of the FCC Rules. Operation is subject to the following two conditions: (1) This device may not cause harmful interference, and (2) This device must accept any interference received, including interference that may cause undesired operation.

This equipment has been tested and found to comply with the limits for a Class A digital device pursuant to Part 15 of the FCC Rules. These limits are designed to provide reasonable protection against harmful interference when the equipment is operated in a commercial environment. This equipment generates uses, and can radiate radio frequency energy and, if not installed and used in accordance with the instruction manual, may cause harmful interference to radio communications. Operation of this equipment in a residential area is likely to cause harmful interference in which case the user will be required to correct the interference at his own expense.

Caution: Exposure to Radio Frequency Radiation.

To comply with FCC RF exposure compliance requirements, a separation distance of at least 20 cm must be maintained between the antenna of this device and all persons.

Caution: Any Changes or modifications not expressly approved by the manufacturer could void the user's authority to operate the equipment.

Class A Digital Device : Wired Device

This Apparatus complies with class "A" limits for radio interference as specified in the Canadian department of communications radio interference regulations.

This Class A digital apparatus complies with Canadian ICES-003.

Appareil numérique de classe A: appareil filaire

Get appareil est conforme aux normes class "A" d'interference radio tel que specifier par ministre canadien des communications dans les reglements d'interference radio.

Cet appareil numérique de la classe A est conform à la norme NMB-003 du Canada.

Waste Electrical and Electric Equipment (WEEE)



This marking shown on the product or its literature, indicates that it should not be disposed with other household wastes at the end of its working life. To prevent possible harm to the environment or human health from uncontrolled waste disposal, please separate this from other types of wastes and recycle it responsibly to promote the sustainable reuse of material resources. Household users should contact either the retailer where they purchased this product, or their local government office, for details of where and how they can take this item for environmentally safe recycling. Business users should contact their supplier and check the terms and conditions of the purchase contract. This product should not be mixed with other commercial wastes for disposal.



WARNING & CAUTION

Is described as death, physical injuries, serious financial losses, and damage to data etc. that can be caused to the user.

Do not connect multiple products to a single or faulty power outlet. Use only grounded power outlets that meet the industry standard. **Noncompliance may cause electric shock or fire.**



Only use authentic products from BIXOLON. The company will not provide post-sale support for damaged or other quality issues that any fake (or refurbished) products may incur.



Do not excessively bend or strain the power cord. Securely push the power cord all the way into the power outlet lest it remain loose. Make sure to hold the cord tight when separating it from the power outlet. Do not remove the power cord while the product is in use. **Noncompliance may cause electric shock or fire.**

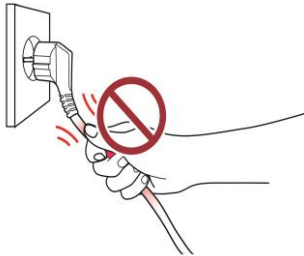

Keep small accessories or other packaging materials away from young children. Beware: choking hazard. **Mishandling the product may incur injuries which may require seeking urgent medical attention.**



Keep excessive liquids away from the power cord and outlet. If matter is smeared onto the power cords, wipe with a dry cloth. **Noncompliance may cause electric shock or fire.**

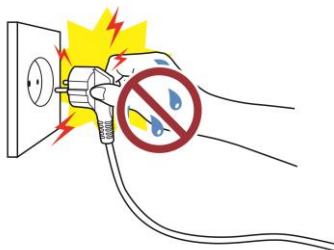

Do not allow the product to be damaged by heavy objects. **Noncompliance may cause electric shock or fire.**

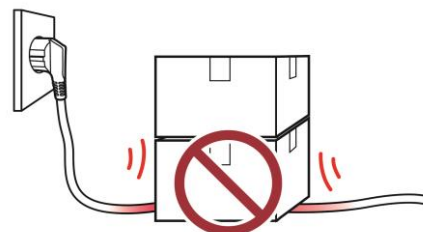

If the product emits a strange sound, burning smell, or smoke, turn off the power immediately and unplug the power cord. If the product is dropped or its exterior is damaged, turn off the power immediately and unplug the power cord. Do not subject the product to shock. **It may start a fire. It may damage the product.**

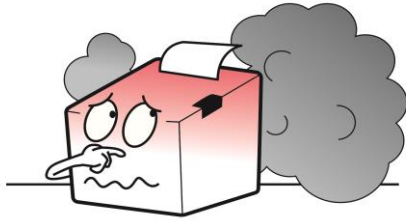

Install the product in a well-ventilated area by keeping it a certain distance from the wall. The product installed in certain places such as where a lot of fine dust is generated, where the temperature is too high or too low, where there is a lot of moisture or water, and at airports or stations that are used continuously for a long time may suffer serious quality problems due to the influence of the surrounding environment. **An increase in internal temperature may start a fire. Be sure to contact the place of purchase before installing the product.**

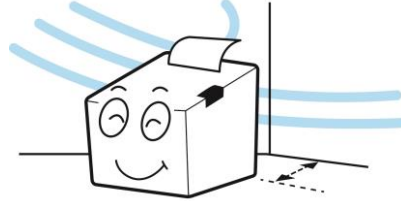

Install the product in a fixed place preventing it from tipping over. When moving the product, turn off the power and disconnect all connected cables, including the power cord. **It may damage the product.**



Never independently disassemble, repair, or modify the product as the warranty will become invalid. **When repair is necessary, contact the original place of purchase.**



Do not let any foreign substances enter the product. Do not place heavy objects, liquids, or metals on the product. **This could cause damage to the product or a fire.**



If there is a problem with the product, please contact the original place of purchase or through BIXOLON website's product repair page (<http://www.bixelon.com>).

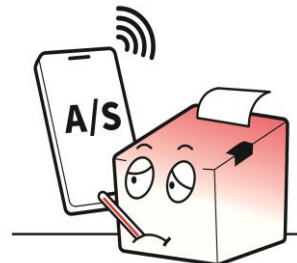

Manual Introduction

This manual provides basic information on printers and provides ways to install, use, and check them. In order to protect the safety of users and prevent property damage, be fully familiar with this manual before using the product. Please use it.

Manual Symbol Introduction

	Precaution & Warning	It describes death, physical injuries, serious financial losses, and damage to data etc. that can be caused to the user.
	Note	It provides additional information on the function and performance of the product.

Product Symbol Introduction

	DC (Direct current)
	Error, Warning
	Paper Feeding
	Stand-By
	USB
	Ethernet

Printer Introduction

SRP-380/382plus printers have been designed to be connected to various types of electronic devices such as POS (Point Of Sales), and computer peripheral devices.

The main features of the printer are as follows

1. THERMAL RECEIPT PRINTER
2. Low-noise thermal transfer method printing
3. Maximum 500mm/s printing speed
4. 147 x 200 x 148 (W X D X H)
5. Serial/Dual Serial/ Parallel /Ethernet/Powered USB/WLAN/Bluetooth Interface
6. Equipped with data buffer (receives print data even while printing)
7. Can print a range of barcodes
8. Range of printing density selectable
(controlled with virtual memory switch management)

Table of Contents

Copyright.....	2
WARNING & CAUTION.....	6
Manual Introduction.....	8
Printer Introduction.....	9
1. Preparation	11
2. Product Part Names	12
2-1 Printer Part Names.....	12
2-2 Interface Part Names	13
2-2-1 USB Interface(Built-in).....	13
2-2-2 Ethernet Interface(Built-in)	14
2-2-3 Single Serial Interface Card (RS-232C)	15
2-2-4 Parallel Interface Card (IEEE-1284).....	16
2-2-5 Wireless LAN Interface Card	17
2-2-6 Bluetooth Interface Card.....	18
2-2-7 Powered USB Interface Card	19
2-2-8 Drawer Kick-out Port.....	20
3. Installation & Usage	22
3-1 Printer Installation Placings	22
3-2 Turn on the Power	23
3-3 Inserting and changing the paper roll	25
3-4 Using Controller.....	28
4. Self-Test.....	29
5. Hexadecimal Dumping.....	32
6. Maintenance	33
6-1 Paper Jam.....	33
6-2 Cleaning Printer	34
7. Specifications	35
7-1 Printer Specifications.....	35
7-2 Recommended Papers	36

1. Preparation



- If there is any part missing, please contact the place of purchase.
- The actual part may look different from the image.

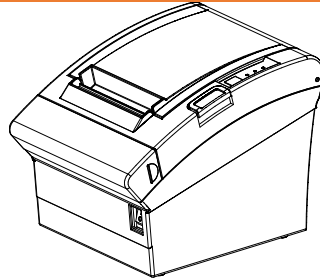

SRP-380/382plus

Standard Components

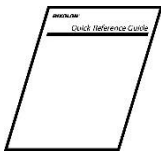

Installation Guide

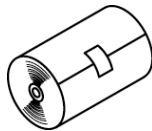

Paper

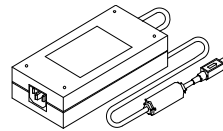

AC/DC Adapter

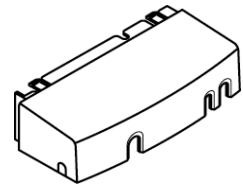

Cover-Cable

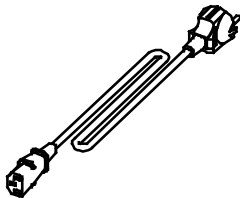

Power Cord

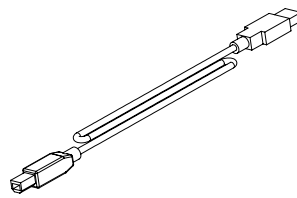

USB A-B Cable

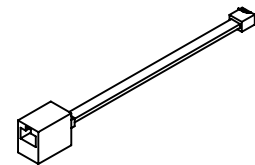

DK Gender

Option Components

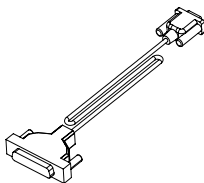

Serial Cable
(9pin - 25pin)

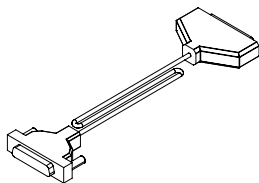

Parallel Cable
(25pin - 36pin)

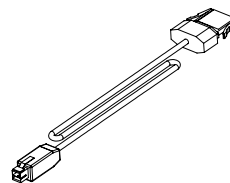

Powered USB
Cable (Standard)

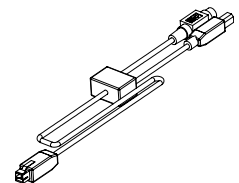

Powered USB
Cable
(Y-USB-B)

2. Product Part Names

2-1 Printer Part Names

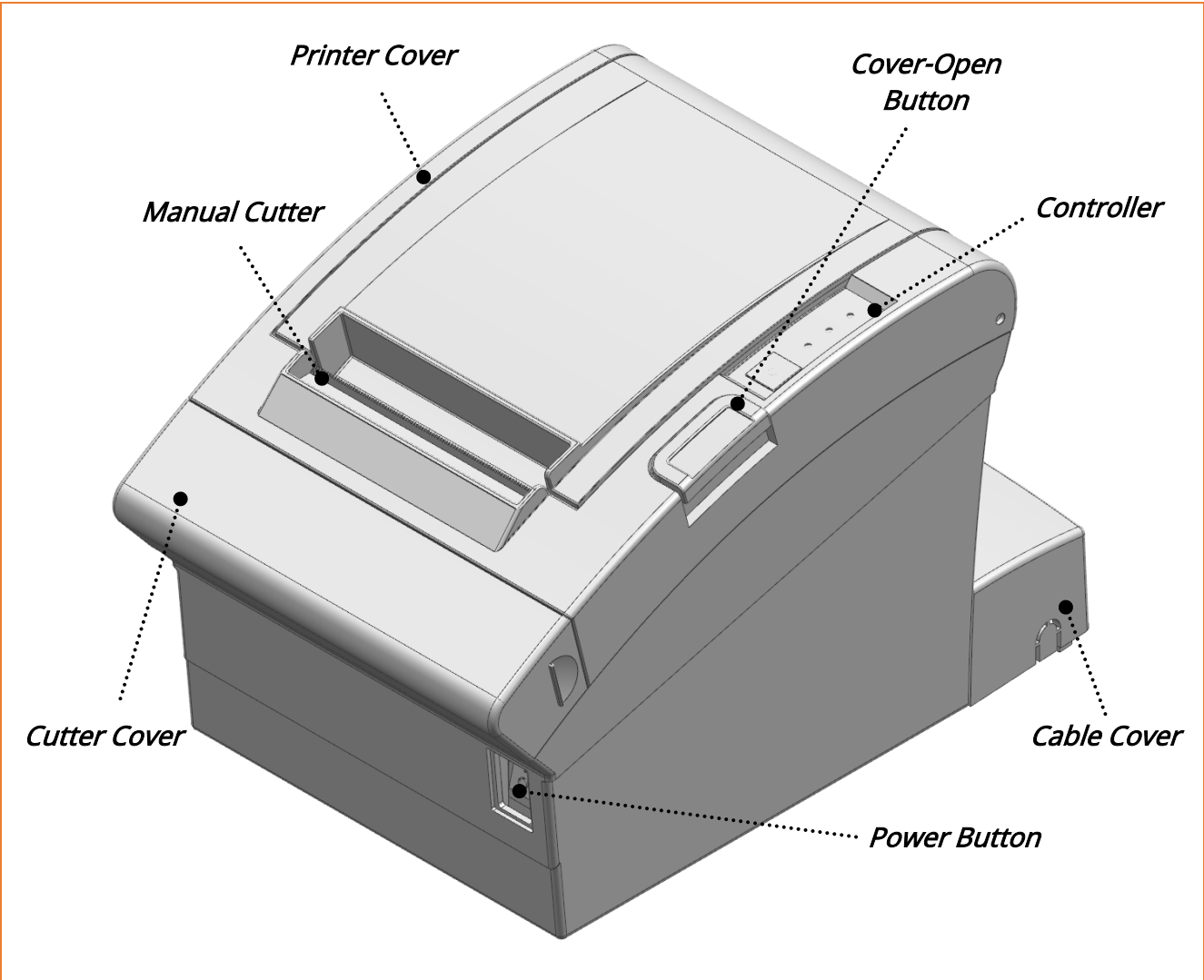

2-2 Interface Part Names

- Connect the printer to the host computer using the right interface cable that complies with the specifications of the interface.

2-2-1 USB Interface(Built-in)

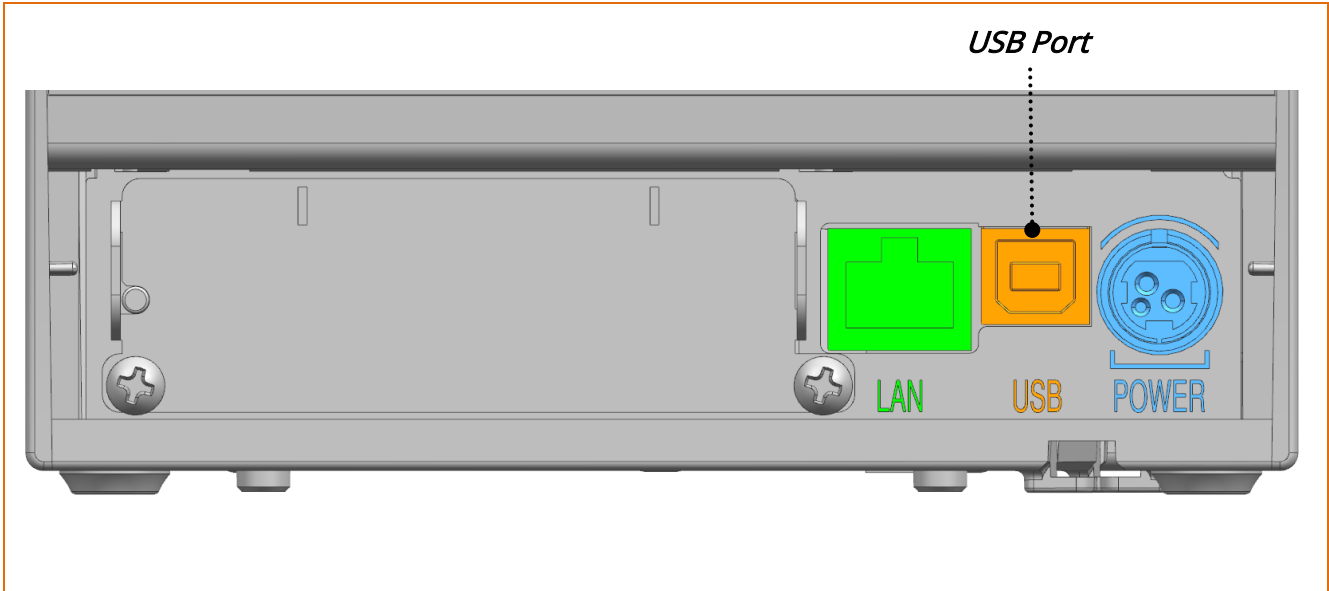

Pin No.	Signal Name	Designation (Color)	Function
Shell	Shield	Drain Cable	Frame Ground
1	VBUS	RED	Host Power
2	D-	WHITE	Data Line (D-)
3	D+	GREEN	Data Line (D+)
4	GND	BLACK	Signal Ground



Connect or disconnect the communication cable while the printer power is off. If power is on, your data may be lost.

2-2-2 Ethernet Interface(Built-in)

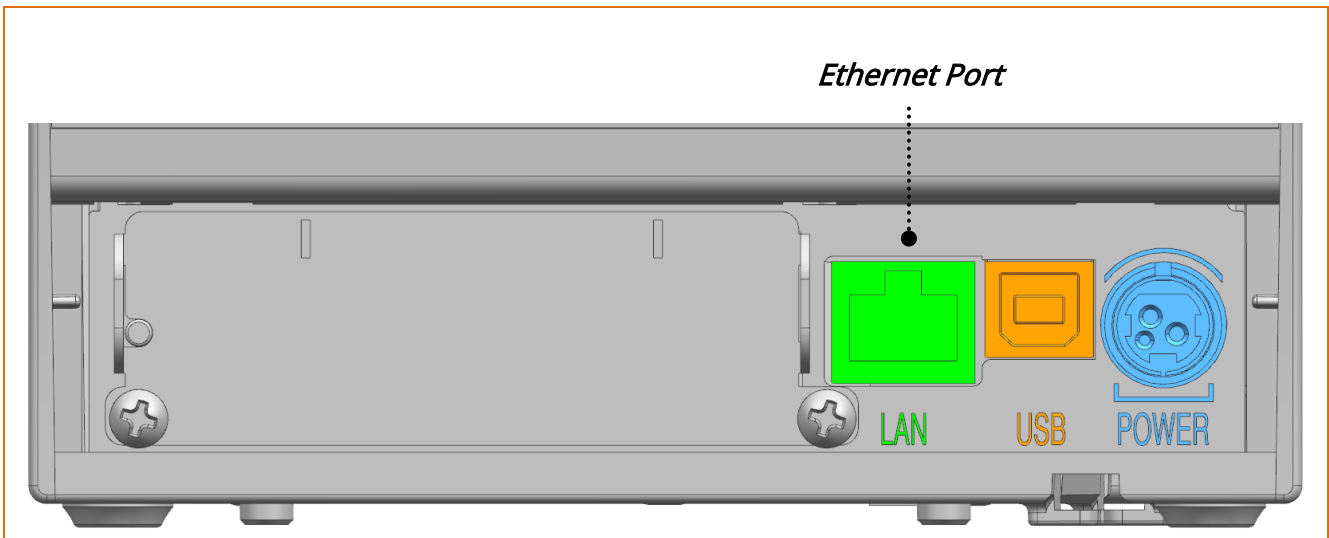

Pin No.	Signal Name	Designation (Color)	Function
1	TD+	WHITE ORANGE	Transmit +
2	TD-	ORANGE	Transmit -
3	CT	WHITE GREEN	Center tap
4	NC	BLUE	-
5	NC	WHITE BLUE	-
6	NC	GREEN	-
7	RD+	WHITE BROWN	Receive +
8	RD-	BROWN	Receive -



Connect or disconnect the communication cable while the printer power is off. If power is on, your data may be lost.



Refer to the utility and network connection manual for Interface connection information. The network connection manual is on the BIXOLON website (www.bixolon.com) We're offering it.

2-2-3 Single Serial Interface Card (RS-232C)

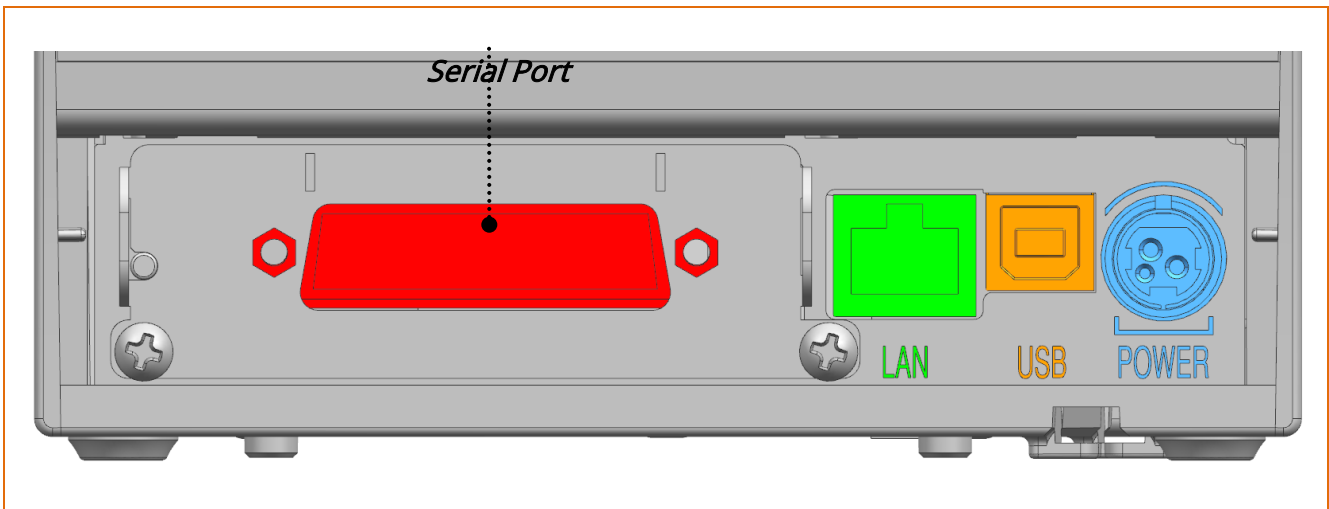

Pin No.	Signal Name	Direction	Function
1	FG	-	Frame Ground
2	TxD	Output	Transmit Data
3	RxD	Input	Receive Data
4	RTS	Output	Ready To Send
6	CTS	Input	Clear To Send
7	SG	-	Signal Ground
20	DTR	Output	Data Terminal Ready



Connect or disconnect the communication cable while the printer power is off. If power is on, your data may be lost.

2-2-4 Parallel Interface Card (IEEE-1284)

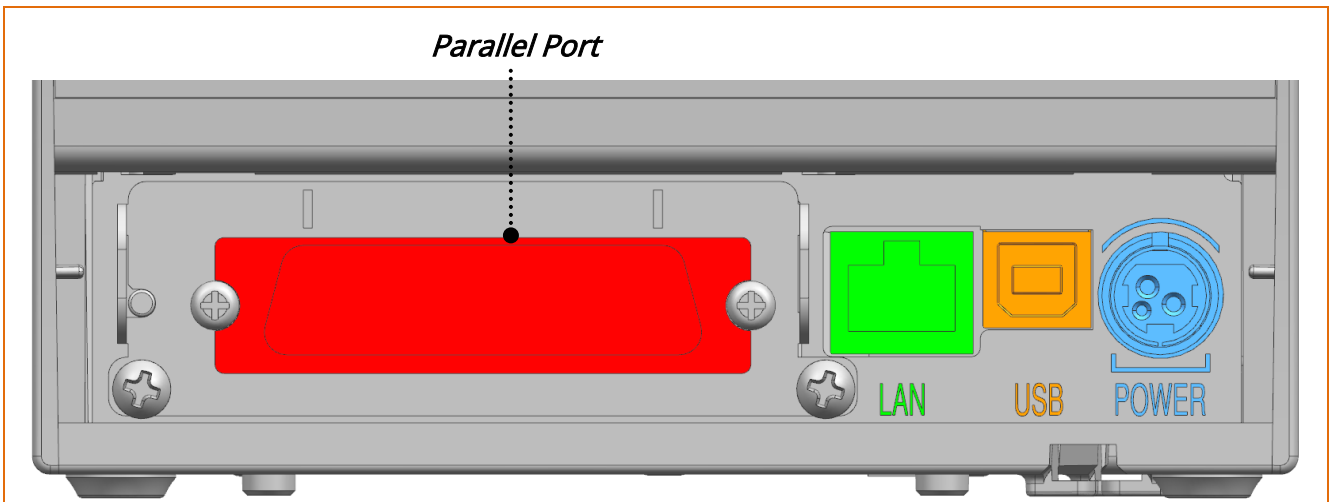

Pin No.	Source	Compatibility Mode	Nibble Mode	Byte Mode
1	Host	nStrobe	HostClk	HostClk
2	Host/Printer	Data 0 (LSB)	-	Data 0 (LSB)
3	Host/Printer	Data 1	-	Data 1
4	Host/Printer	Data 2	-	Data 2
5	Host/Printer	Data 3	-	Data 3
6	Host/Printer	Data 4	-	Data 4
7	Host/Printer	Data 5	-	Data 5
8	Host/Printer	Data 6	-	Data 6
9	Host/Printer	Data 7 (MSB)	-	Data 7 (MSB)
10	Printer	Nack	PtrClk	PtrClk
11	Printer	Busy	PtrBusy /Data3,7	PtrBusy
12	Printer	Perror	AckDataReq/Data2,6	AckDataReq
13	Printer	Select	Xflag/Data1,5	Xflag
14	Host	nAutoFd	HostBusy	HostBusy
15	-	NC	NC	NC
16	-	GND	GND	GND
17	-	FG	FG	FG
18	Printer	Logic-H	Logic-H	Logic-H
19~30	-	GND	GND	GND
31	Host	nInit	nInit	
32	Printer	nFault	nDataAvail/Data0,4	
33	-	GND	ND	
34	Printer	DK_Status	ND	
35	Printer	+5V	ND	
36	Host	nSelectIn	1284-Active	



Connect or disconnect the communication cable while the printer power is off. If power is on, your data may be lost.

2-2-5 Wireless LAN Interface Card

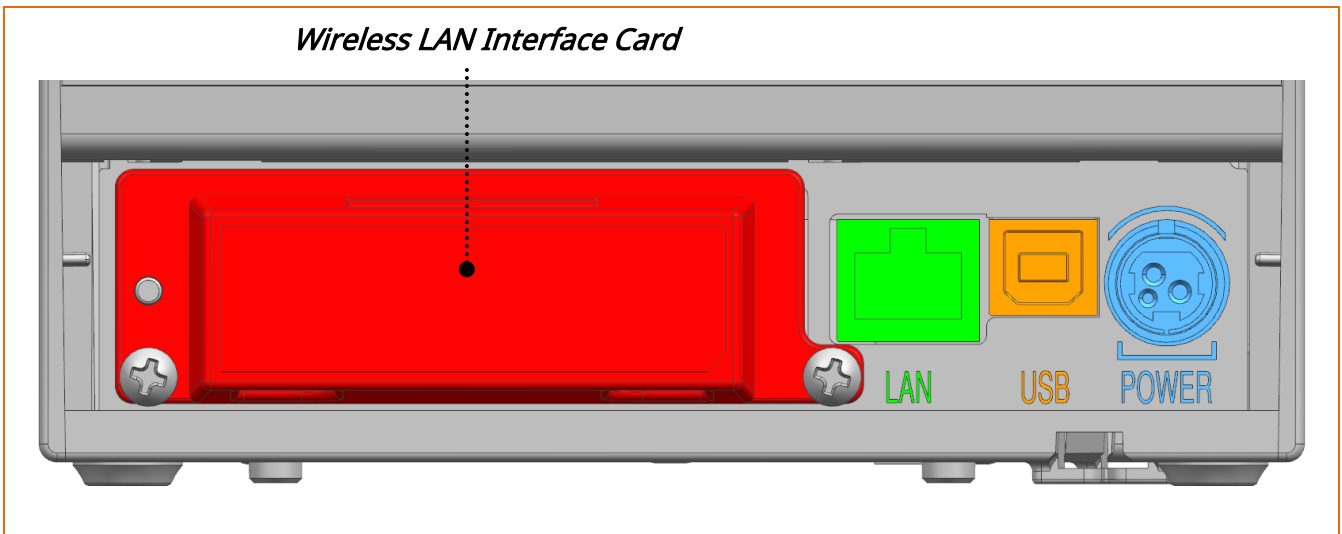

1) Wireless LAN Communication Specifications

Item	Specifications
Frequency	2.4GHz / 5GHz
Protocol	802.11 a/b/g/n

2) Connecting Wireless LAN

Printer can be connected to terminal devices with wireless LAN communication capability (PDA, PC, smartphone, tablet PC, etc.).



Refer to the Network Connection Manual for more detailed instructions about how to establish the connection. The Network connection manual is on the BIXOLON website (www.bixolon.com) We're offering it.

2-2-6 Bluetooth Interface Card

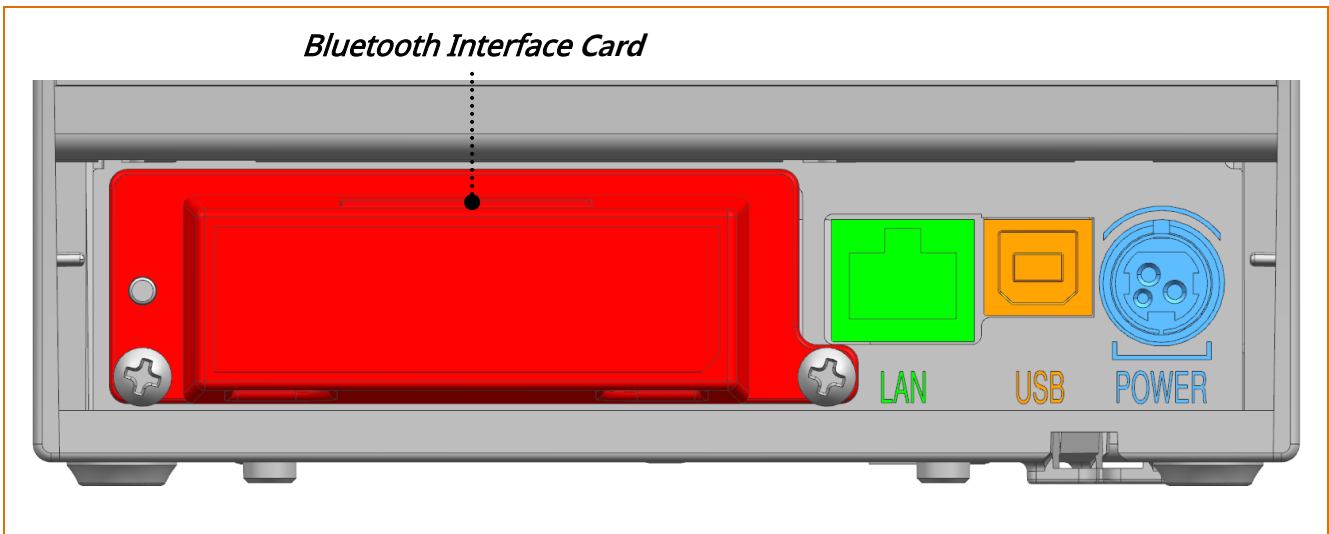

1) Bluetooth Communication Specifications

Item	Specifications
Frequency	2.402~2.480 GHz
Version	5.2

2) Bluetooth Connection

Printer can be connected to terminal devices with Bluetooth communication capability (PDA, PC, smartphone, tablet PC, etc.)



Refer to the Bluetooth Connection Manual for more detailed instructions about how to establish the connection. The Bluetooth Connection manual is on the BIXOLON website (www.bixolon.com) We're offering it.

2-2-7 Powered USB Interface Card

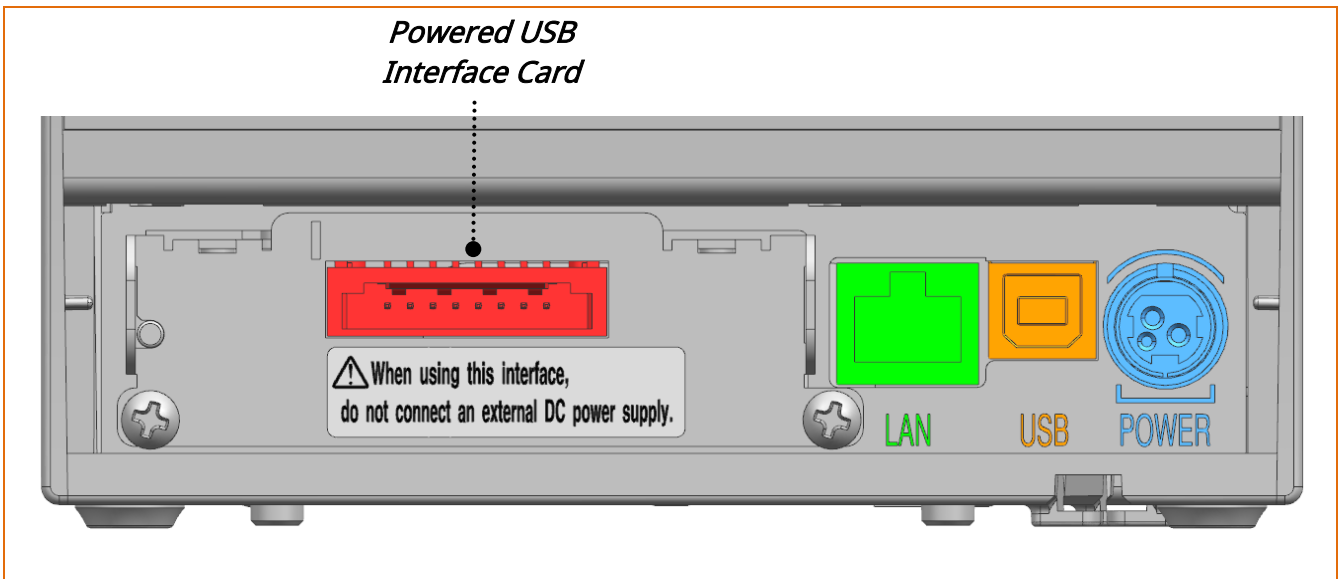

Pin No.	Signal Name	Function
Shield	Shield	Prevent Noise
1	PGND	Main Power Ground
2	VPP24V	Main Power
3	GND	Signal ground
4	D+	Data Line (D+)
5	D-	Data Line (D-)
6	VBUS	Host Power
7	VPP24V	Main Power
8	PGND	Main Power Ground



- Refer to www.powered.org for detailed information related to the specifications of cable and port.
- Do not apply SMPS 24V when using powered USB. (Powered USB uses its own power.)
- In case of using Powered USB interface, the other USB interface provided by default is not useful. (In this case, USB communication is only available through the Powered USB)

2-2-8 Drawer Kick-out Port

Connect the Drawer Kick-out connection cable to the drawer kick-out port on the bottom side of the printer.

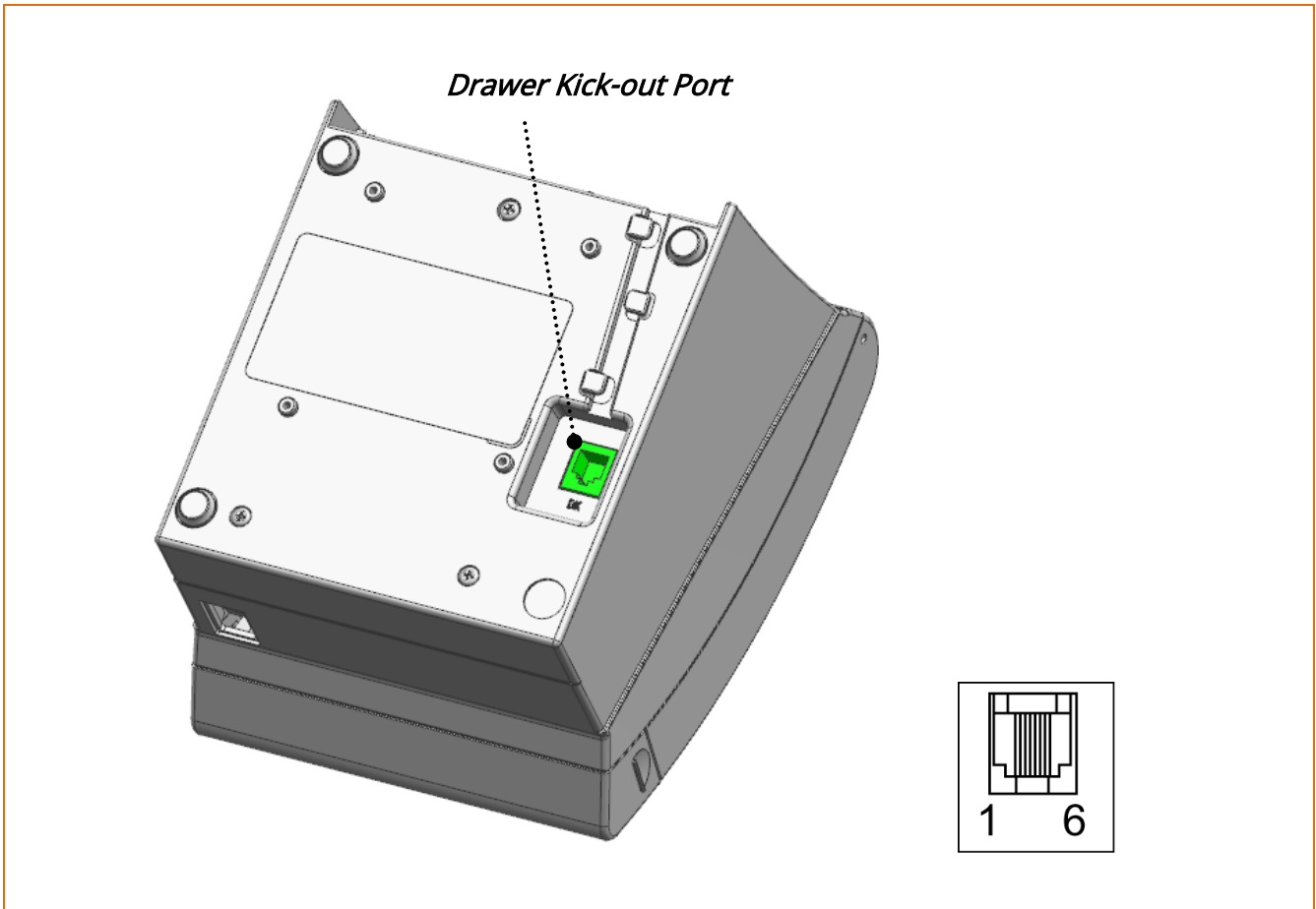

Pin No.	Signal Name	Direction
1	Frame Ground	-
2	Drawer Kick-out Drive Signal 1	Output
3	Drawer Open/Close Signal	Input
4	+24V	-
5	Drawer Kick-out Drive Signal 2	Output
6	Signal Ground	-



- Use a cash drawer that meets the printer specifications. Using a cash drawer that is inappropriate to the specs or Using it as a power supply for a separate device may result in damage to the product
- Do not connect a telephone line to the drawer kick-out port. Otherwise, the telephone line and the computer may be damaged.
- Do not allow a foreign object such as a conductor to touch the drawer kick-out port. This may result in damage to the product.
- Make sure to use a cash drawer with an internal coil resistance of 24Ω or higher. (The maximum current is 1A.)
- The open signal time for the cash drawer should not exceed 0.8 seconds. After opening the cash drawer, make sure to idle for at least 3.2 seconds (at least 4 times that of the open signal time) before operating it.

3. Installation & Usage

3-1 Printer Installation Placings

- Allow sufficient space around the printer for proper ventilation.
- Do not place objects close to the back or bottom of the printer, which may hinder the air circulation.
- Install the printer on a flat and level surface.
- Avoid humid environment.
- Install in a place that does not exceed the protocol standard of the wireless communication or the specified maximum distance.
- For stable wireless communication, install in a place where there is no physical obstacle (wall, object, etc.).

3-2 Turn on the Power

1) After turning the printer off, connect the AC/DC adapter jack to the printer's power port.

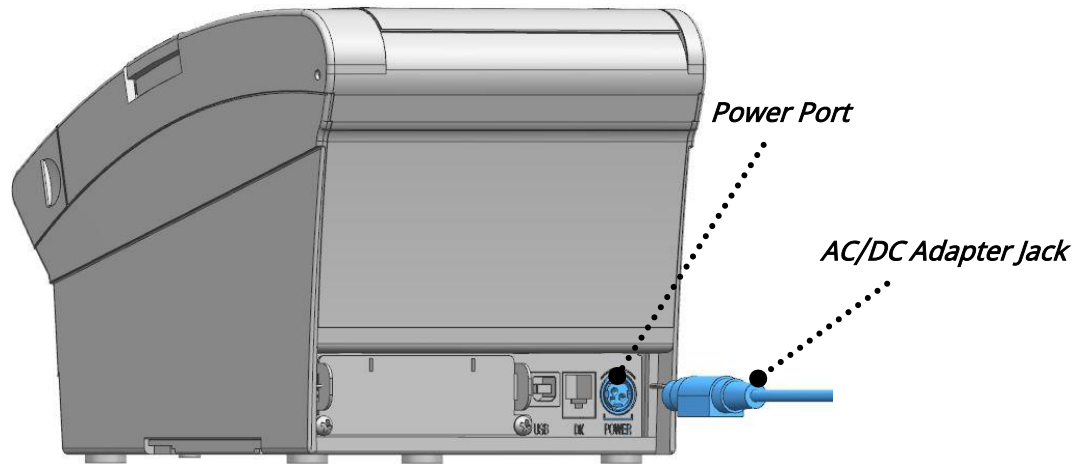

2) When connecting the adapter jack, ensure that it is inserted in the correct direction.

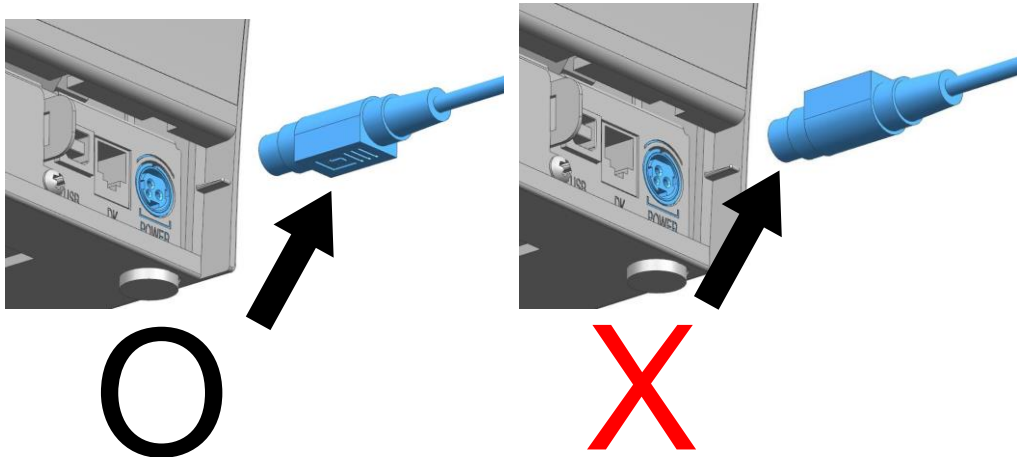

3) Connect the power cord to the AC/DC adapter and plug it into the power outlet on the wall.

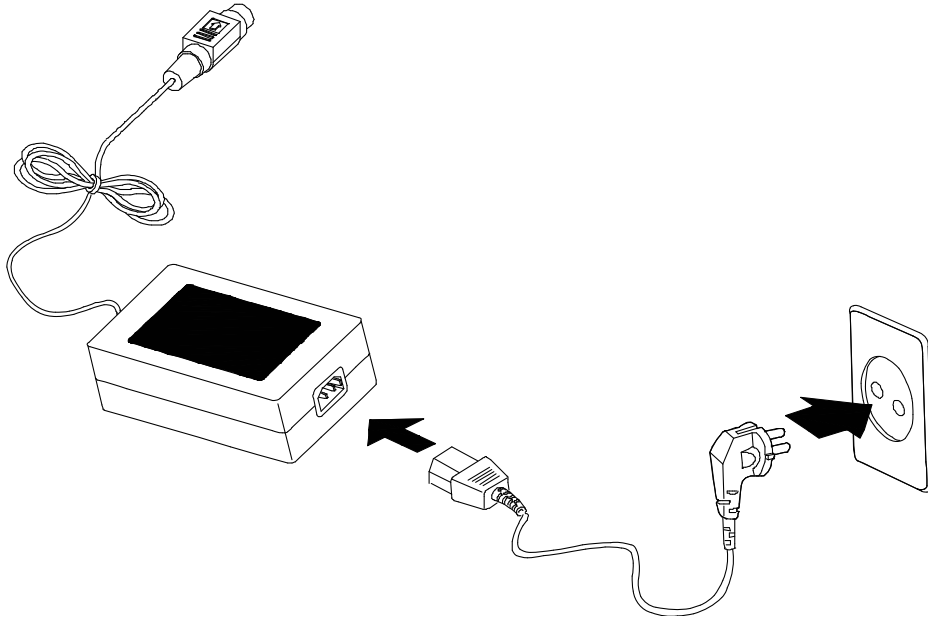

4) Press the “ON” switch to turn on the printer.



- Only use a power supply provided by BIXOLON. BIXOLON shall bear no responsibility for damage caused by using a third-party power supply.
- Be sure to turn off the printer and connect or disconnect the cable.
- Check the power supply’s label to check its electronic specs.
- When removing the power supply, make sure you have a firm grasp of the plug terminal of the power cable and the printer and pull horizontally.
- When connecting or disconnecting power, make sure to remove the power supply from the power outlet before removing.
- Pay attention to the direction in which you insert the power cord.
- Do not connect a voltage out of the specifications of the power supply. It can cause damage to the product or a fire.

3-3 Inserting and changing the paper roll



Use paper roll that complies with the specifications.

If you use a paper roll including paper core attached to paper, the paper may not be properly recognized as paper Empty due to not proper releasing of paper.



- When opening or closing the cover, be careful not to pinch your fingers.

- Do not open the print head levers while the printer is printing. The printer may be damaged.

- Change the paper when the printer is not receiving data, or data may be lost.

- While the printer is operating, the printer head gets very hot, so turn off the power and let it cool down completely. The hot printer head can cause serious burns.

1) Open the Printer Cover by pushing the Cover-Open Button.



When you change the paper, remove the used paper roll.

2) Replace with a new one as shown in the image.

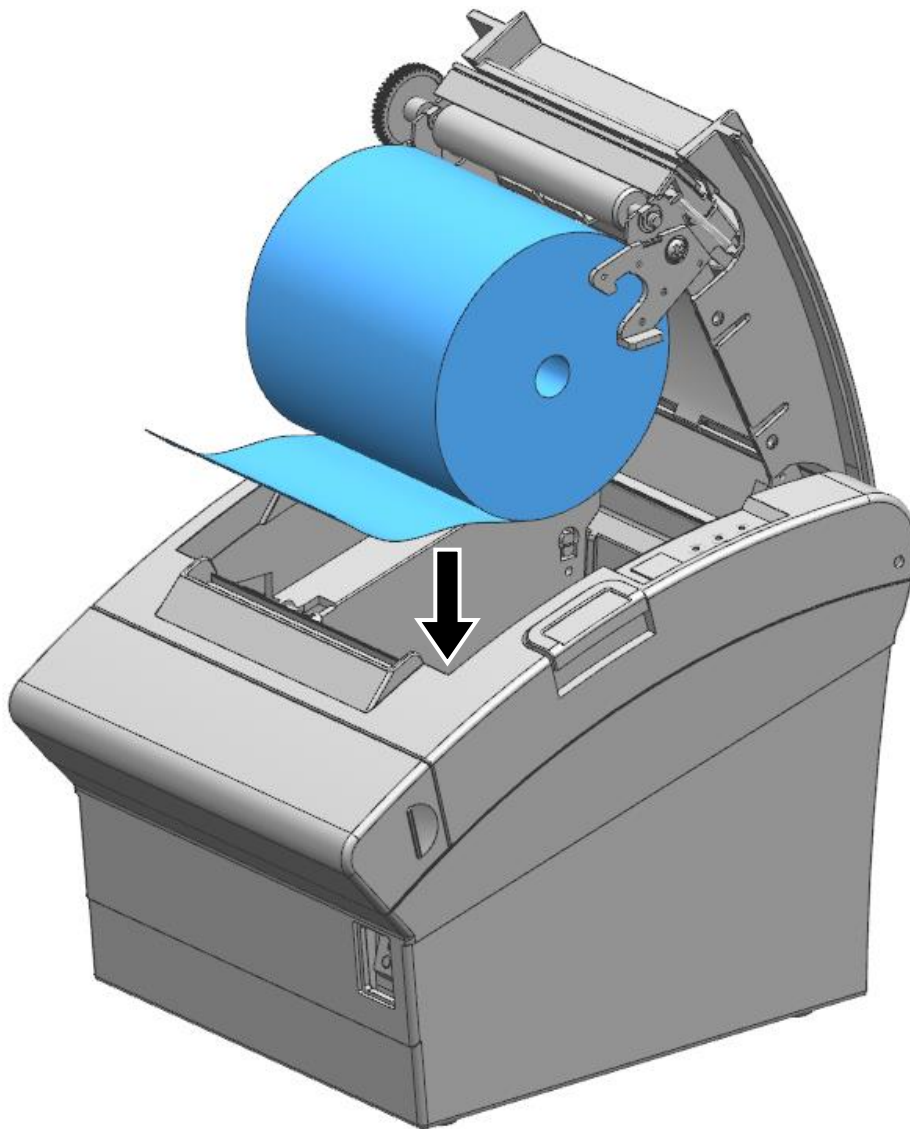

3) Check the orientation of the roll paper when inserting it into the printer.

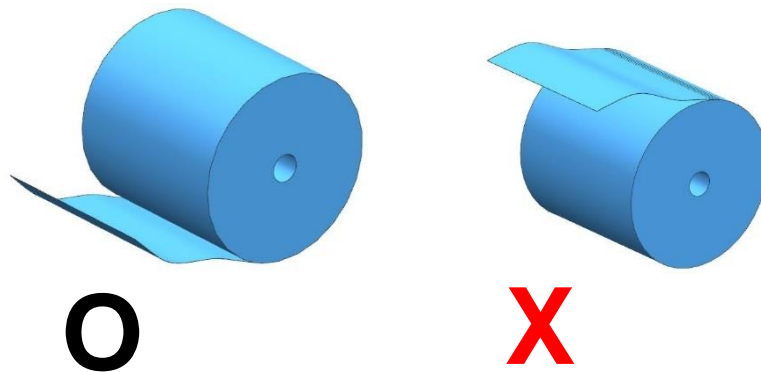

4) Pull out a small amount of paper as shown in the picture, and close the Printer Cover.

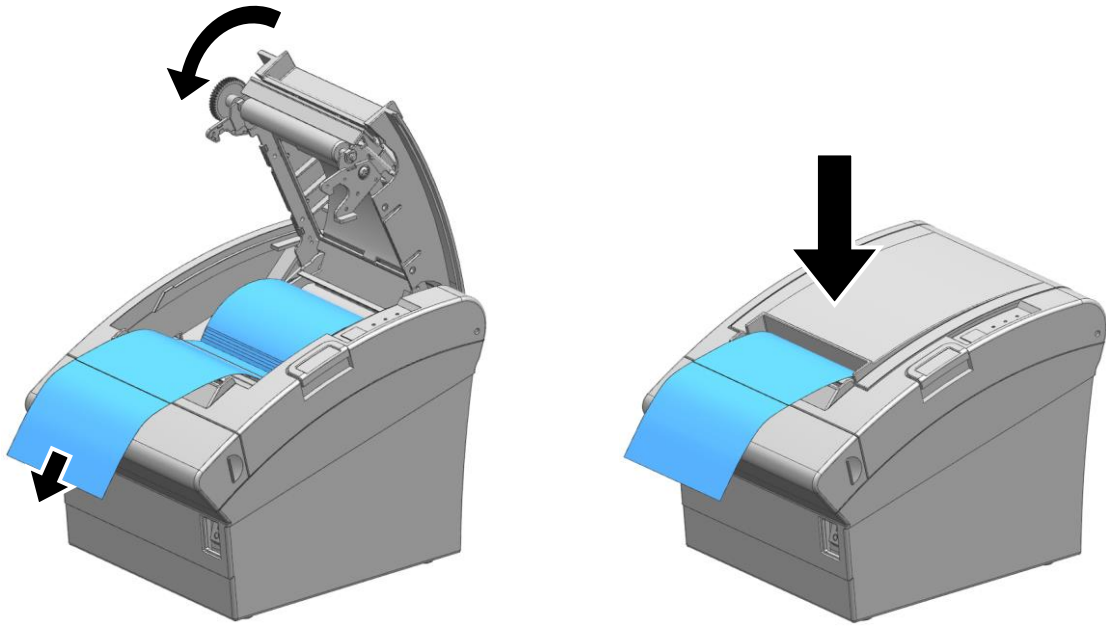



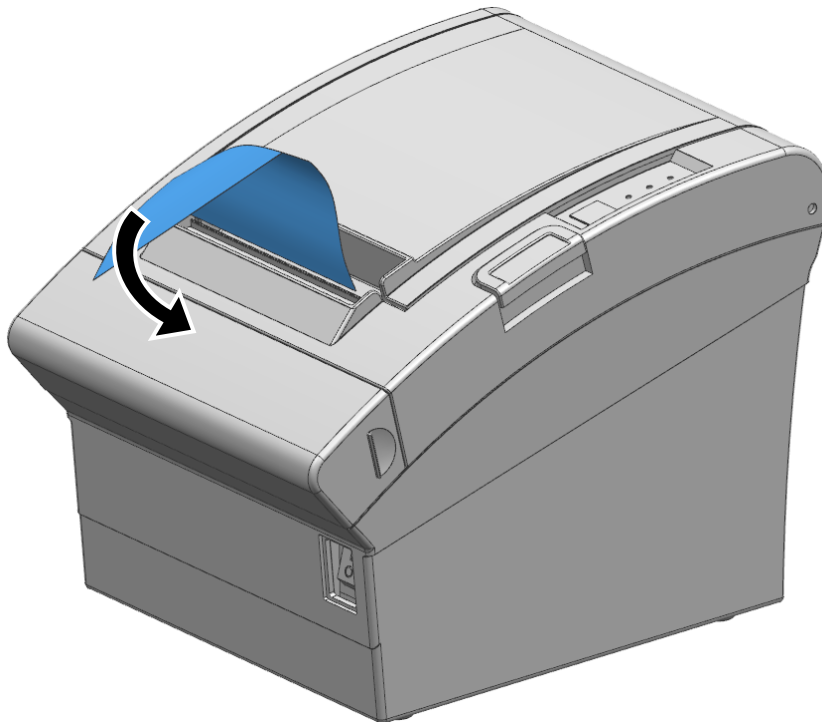

When closing the cover, hold down the center of printer cover firmly so that paper roll is loaded correctly.

5) Cut out the paper as indicated.

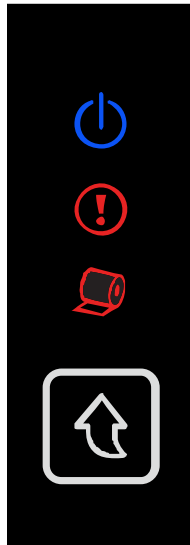

3-4 Using Controller



Explanation		
	Power LED	The Power LED light is on whenever the printer is on.
	Error LED	Error LED is on when there is an error such as no paper roll, open cover, etc.
	Paper LED	Paper LED is on when the paper roll is almost used up or there is no paper roll inside. Paper LED flickers when the machine is in a self-diagnosis stand-by or macro execution stand-by state.
	Feed Button	Press the Feed button once to output one line of the paper roll. Press the Feed button for more than 3 seconds to output the paper roll continuously.



If the printer does not power on, check that the adapter LED indicates "ON" If the adapter LED is "OFF", connect the adapter power.

4. Self-Test

The self-test checks whether the printer has any problems.

If the self-diagnostics reveal no error in the printer, please see other device or software.

If the printer does not run normally, please contact the place of purchase.



- Do not open the top cover while the printer is running.
- If the printer does not run normally, please contact Customer Center.

- 1) Make sure paper roll has been installed properly.
- 2) Turn on the power while holding down the FEED button and the self-test begins.
- 3) The self-test prints the current status of the printer including control ROM version.
- 4) After printing the current printer status, the printer wait for the next step after printing the following lines. (The paper signal light keeps blinking.)

SELF-TEST PRINT COMPLETE	
SELECT MODES BY PRESSING FEED BUTTON.	
End of Self-Test	: Less than 1 second
VMSM Selection	: 1 second or more

- 5) To continue printing, press the FEED button for 1 second or longer to set the memory switch configuration mode.

(1) If you select "Continuous SELF-TEST"

- ① Press the FEED button for less than 1 second, and the printer prints the pre-created character format.
- ② The self-test ends automatically and the printer prints the following text and then cuts the paper.

*** COMPLETED ***

- ③ The printer returns to its normal state immediately after the self-test is finished.

(2) If you select "VMSM Selection"

- ① When entering the memory switch configuration mode, the following message is printed.

<p>** VMSM Selection ** 0: Exit and reboot printer 1: Print current settings 2: Set Print Density 3: Set Print Speed 4: Set Cutting mode 5: Set Buzzer 6: Set Near-End Sensor 7: Set Serial Interface</p>
--

- ② To execute the above function, operate the FEED button as follows.
- ▶ Step 1 (selecting desired item): Press the button as many times as the number displayed before each menu to select the desired setting menu.
 - ▶ Step 2 (entering setting item): Press and hold the button for 1 second to apply the selected item.
- ③ Execute the "0: Save settings and exit" function to apply the changed settings. When "Save settings and exit" mode is active, the above message will be displayed and the printer will reboot.

<p>*** COMPLETED ***</p>



- If you select any items not listed above, the list of "VMSM Selection" will be printed again. Setting the mode will be canceled if no item is selected in Step 1.
- If the "0: Save settings and exit" function is not executed, The setting information is not stored in the printer.

5. Hexadecimal Dumping

This function allows experienced users to see exactly what data is coming to the printer. This can be useful in finding software problems. When you turn on the hexadecimal dump function, the printer prints all commands and data in hexadecimal format along with a guide section to help you find specific commands.

- 1) After making sure that the printer is off, open the cover.
- 2) Turn the printer on, while holding down the FEED button.
- 3) Close the cover, and then the printer enters the hexadecimal dump mode.
- 4) Select the hexadecimal printing function in the mode selection menu to move to the hexadecimal printing mode.
- 5) Run any software program that sends data to the printer.
The printer will print all the codes it receives in a two-column format.
The first column contains the hexadecimal codes and the second column gives the ASCII characters that correspond to the codes.

```

1B 21 00 1B 26 02 40 40 40 40    . ! . . & . @ @ @ @
02 0D 1B 44 0A 14 1E 28 28 28    . . . D . . . . ( ( (
00 01 0A 41 0D 42 0A 43 43 43    . . . A . B . C C C

```

- A period (.) is printed for each code that has no ASCII equivalent.
- During the hex dump, all commands are disabled.

- 6) When the printing finishes, turn off the printer.
- 7) Turn on the printer and then the hexadecimal mode is off.



Contact the customer center if the printer does not enter hexadecimal printing mode.

6. Maintenance

6-1 Paper Jam

- Never force the paper out in the event of a paper jam.
If paper is stuck, turn the printer ON/OFF and open the cover to remove the crumpled paper inside the printer. If the Printer Cover will not open, please follow the following instructions.
- 1) Turn the printer OFF.
 - 2) Pull out the Cutter Cover to separate from the printer.
 - 3) Turn the knob and insert the blade that sticks out using a cross-head screwdriver as shown below.
 - 4) Push the cover-open button and remove the jammed paper.
 - 5) Put the Cutter Cover back in place.
 - 6) Turn the printer ON and use it.

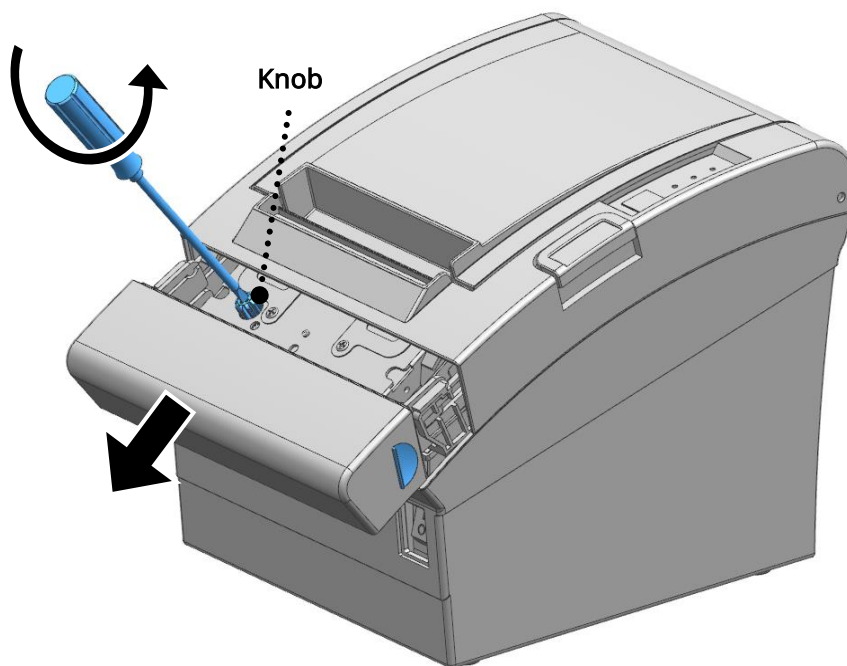

If the cover does not open, do not forcibly open it.
It may result in poor paper cutting or printer damage.



- Placing your hand above the printer outlet may cause a paper jam.
- In case of a minor jam, it may be possible that the operating blade returns to the original position by turning the printer OFF and then back ON.

6-2 Cleaning Printer

- The presence of dust, foreign matter, adhesive matter, or other pollutants inside the printer's head and internal capacity may undermine printing quality. Periodic cleaning (every 3 months at minimum) is recommended to maintain print quality.

- 1) Open the Printer Cover and remove the paper currently in use.
- 2) Residue or contamination of TPH should be wiped out by alcohol for medical.
- 3) Insert a paper roll and close the Printer Cover.

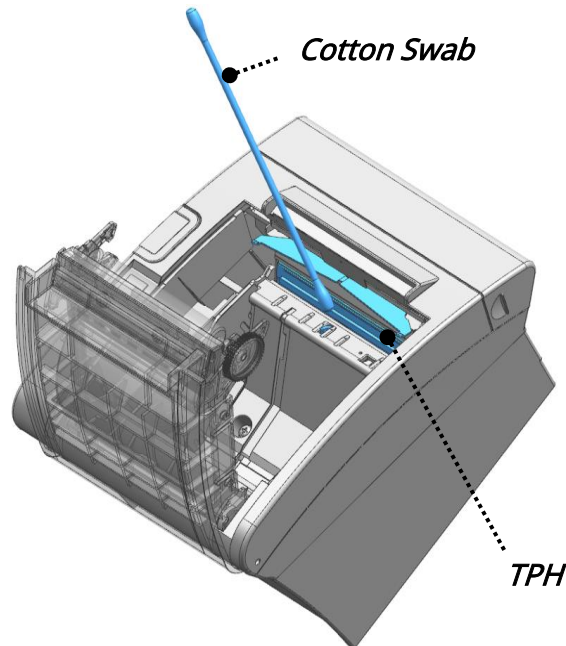

- Be sure to clean after turning the printer off.
- Be careful not to leave scratches in the print head. The printer may be damaged.
- Print head is very hot while the printer is printing, so clean the printer after cooling it sufficiently with power off.
- Do not touch heated area of print-head when cleaning. Personal injury may result from static electricity, etc.

7. Specifications

7-1 Printer Specifications

Printing Method	Thermal printing	
Dot Density	SRP-380plus: 180 dpi (7dots/mm) SRP-382plus: 203 dpi (8dots/mm)	
Printing Width	3-inch	73.1 mm
Paper Width	3-inch	79.5±0.5 mm
No. of Characters per Line (Default Value)	SRP-380plus: 42 (Font A), 56 (Font B), 56 (Font C) SRP-382plus: 48 (Font A), 64 (Font B), 64 (Font C)	
Printing Speed	MAX. 500 mm/sec	
Receiving Buffer Size	4K bytes	
Interface	Serial / Ethernet / Parallel WLAN(2.4GHz,5GHz) / Bluetooth / USB / Powered USB	
Cash Drawer Kick Out Port	2ports with Y-type cable	
AC/DC Adaptor	Input Voltage	100~240 VAC
	Frequency	50/60 Hz
	Output Voltage	+24 Vdc ± 5%
	Output Current	2.5A
Environment Condition	Temperature	Operating: 0 ~ 40 °C Storage: -20 ~ 60 °C
	Humidity	Operating: 10 ~ 80 % RH Storage: 10 ~ 90 % RH Paper excluded
Life Span	Printer Head	300 Km
	Auto Cutter	3,000,000 cuts



The specifications were determined based on operation at normal temperature using designated paper on default settings. They are subject to change depending on temperature or printing level. Printing speed may become slightly slower depending on the data transmission speed and the combination of commands.

7-2 Recommended Papers

- TF50KS-E (Paper Thickness: 65µm): Nippon Paper Industries Co., Ltd.
- PD 150R (Paper Thickness: 75µm): New Oji Paper Mfg, Co., Ltd.
- PD 160R (Paper Thickness: 75µm): New Oji Paper Mfg, Co., Ltd.
- P350 (Paper Thickness: 62µm): Kansaki Specialty Paper, Inc. (USA)
- P220AG (Paper Thickness: 65µm): Mitsubishi Paper Mills Limited
- P220A (Paper Thickness: 65µm): Mitsubishi Paper Mills Limited
- F5041 (Paper Thickness: 65µm): Mitsubishi HitecPaper Flensburg GmbH
- P5047 (Paper Thickness: 60µm): Mitsubishi Paper Mills Limited



- The use of papers other than those recommended above may cause damage to the printer's TPH or degrade the printing quality. BIXOLON is not responsible for the damage caused by non-recommended papers.
- If you have to use other products, we recommend that you use papers with a similar level of quality to the recommended ones.

