

**BIXOLON®**

**User's Manual**

**SRP-Q200**

---

**THERMAL RECEIPT PRINTER**

**Ver. 1.00**

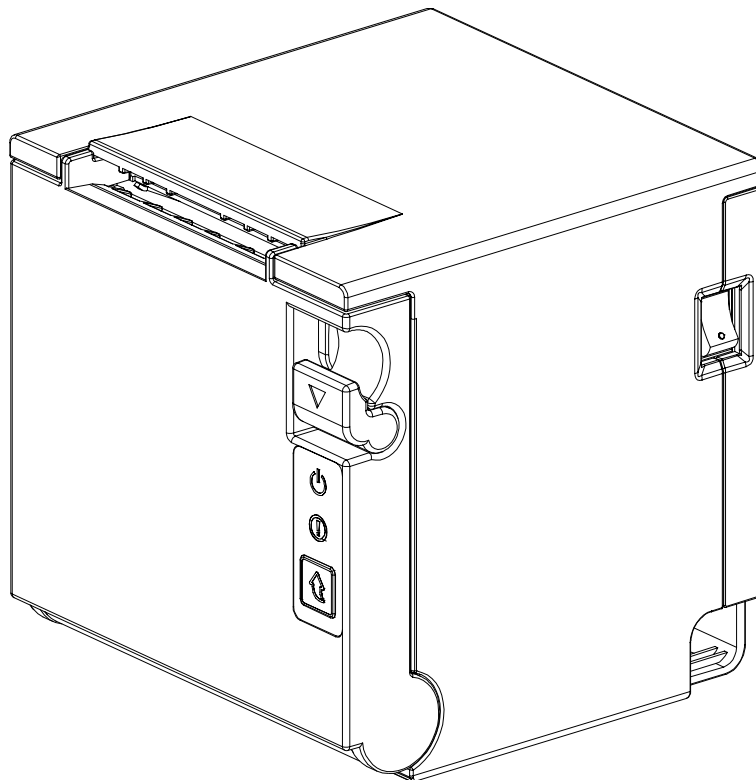

<http://www.bixolon.com>

## Introduction

SRP-Q200 printers have been designed to be connected to various types of electronic devices such as POS (Point Of Sales), and computer peripheral devices.

### **※ The main features of the printer are as follows**



1. THERMAL RECEIPT PRINTER
2. Low-noise thermal transfer method printing
3. Maximum 250mm/s printing speed
4. 103 x 104 x 109 (W X D X H)
5. Interface : Serial, USB, Ethernet, WLAN, Bluetooth
6. Equipped with data buffer (receives print data even while printing)
7. Can print a range of barcodes
8. Range of printing density selectable  
(controlled with virtual memory switch management)

It is advisable to read the contents of this manual carefully before using the printer for the first time.





### **※ Use only authorized supplies that can be trusted!**

- We are not responsible for quality and service for damage caused by the use of unauthorized products (or recycled ones).

## Safety Information

-  **Warning:** Warnings must be heeded carefully in order to prevent serious physical harm.
-  **Caution:** Cautions must be heeded in order to prevent minor injuries, equipment damage, or data loss.

## Symbol Information

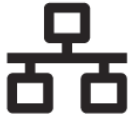
|   |                     |
|---|---------------------|
|    | DC (Direct current) |
|    | Error, Warning      |
|    | Paper Feeding       |
|   | Stand-By            |
|  | USB                 |
|  | Ethernet            |

## Table of Contents

|  |           |
|--|-----------|
| <b>1. Installing Printer and Getting Started</b> ..... | <b>5</b>  |
| 1-1 Unpacking .....                                    | 5         |
| 1-2 Interface .....                                    | 6         |
| 1-2-1 USB Interface.....                               | 7         |
| 1-2-2 Ethernet Interface.....                          | 8         |
| 1-2-3 Serial Interface (RS-232C).....                  | 9         |
| 1-2-4 Wireless LAN Interface (Option).....             | 10        |
| 1-2-5 Bluetooth Interface (Option) .....               | 10        |
| 1-3 Drawer Kick-out Port .....                         | 11        |
| 1-4 Connecting Power Supply .....                      | 12        |
| 1-5 Reconfiguration of Printer.....                    | 14        |
| 1-6 Installing & Replacing Paper .....                 | 15        |
| 1-7 Recommended Papers .....                           | 18        |
| 1-8 Removing Paper Jam.....                            | 18        |
| 1-9 Using Printer Functions .....                      | 19        |
| <b>2. Self-Test</b> .....                              | <b>20</b> |
| <b>3. Hexadecimal Dumping</b> .....                    | <b>22</b> |
| <b>4. Cleaning Printer</b> .....                       | <b>23</b> |
| <b>5. Specifications</b> .....                         | <b>24</b> |

# 1. Installing Printer and Getting Started

## 1-1 Unpacking

- Check the following contents list, and contact your dealer for assistance if any item is missing or incorrect.

### - Product

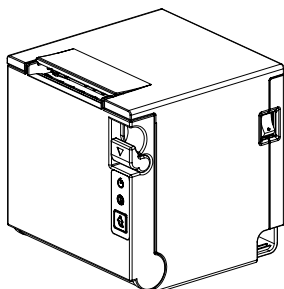

SRP-Q200

### - Standard Components

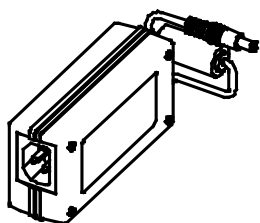

AC/DC Adaptor

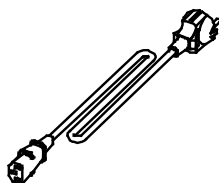

Power Cord

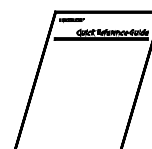

Installation Guide

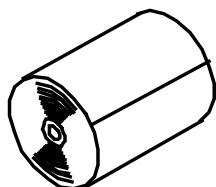

Roll Paper

### - Optional Components

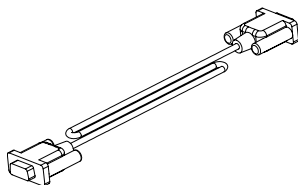

Serial Cable  
(9pin - 9pin)

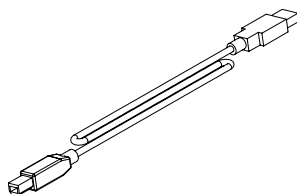

USB A-B Cable

**1-2 Interface**

- Connect the printer to the host computer using the right interface cable that complies with the specifications of the interface

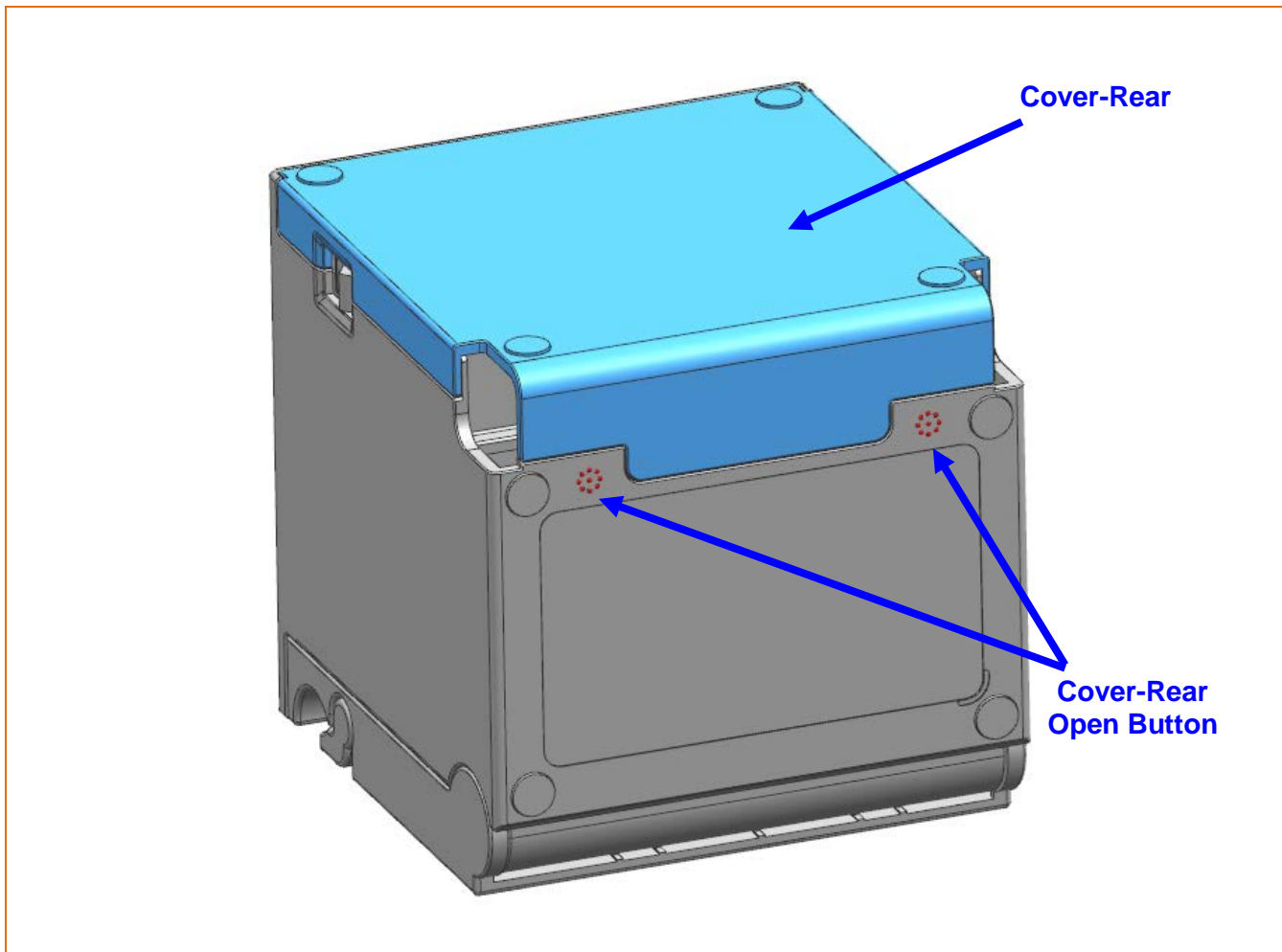

**Note**

To detach cover-rear easily, press cover-rear Open Button.

1-2-1 USB Interface

- Model : SRP-Q200S

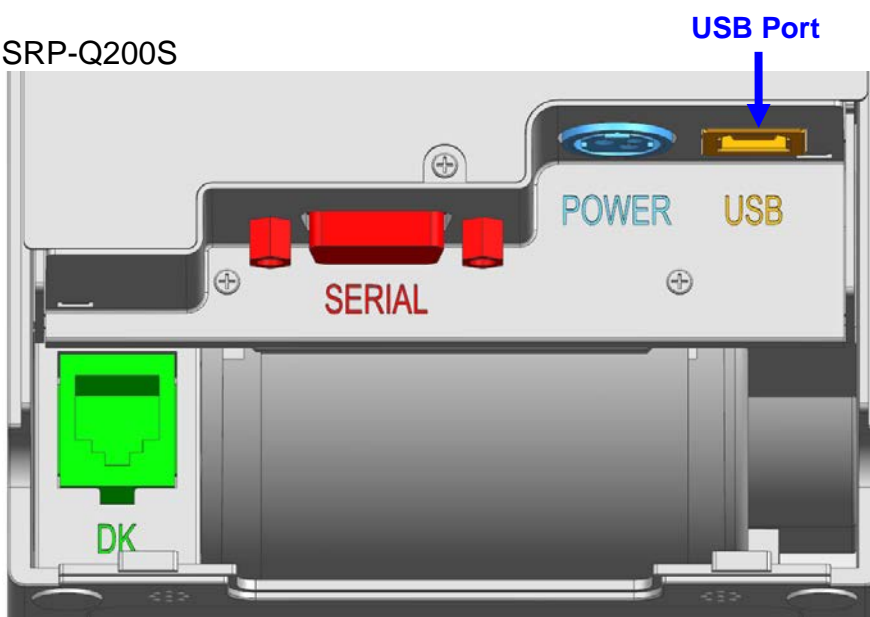

- Model : SRP-Q200Ex

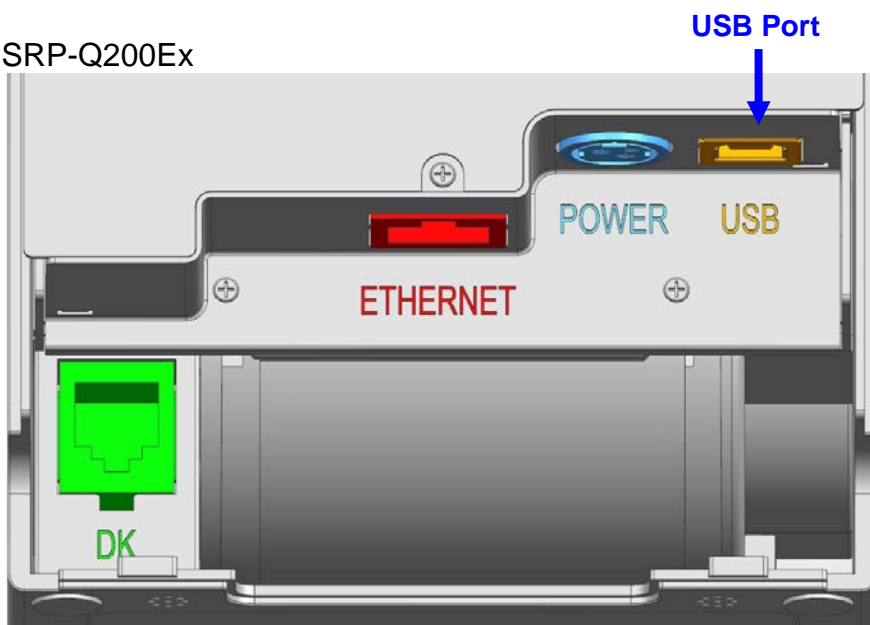

| Pin No. | Signal Name | Designation (Color) | Function       |
|---------|-------------|---------------------|----------------|
| Shell   | Shield      | Drain Cable         | Frame Ground   |
| 1       | VBUS        | RED                 | Host Power     |
| 2       | D-          | WHITE               | Data Line (D-) |
| 3       | D+          | GREEN               | Data Line (D+) |
| 4       | GND         | BLACK               | Signal Ground  |



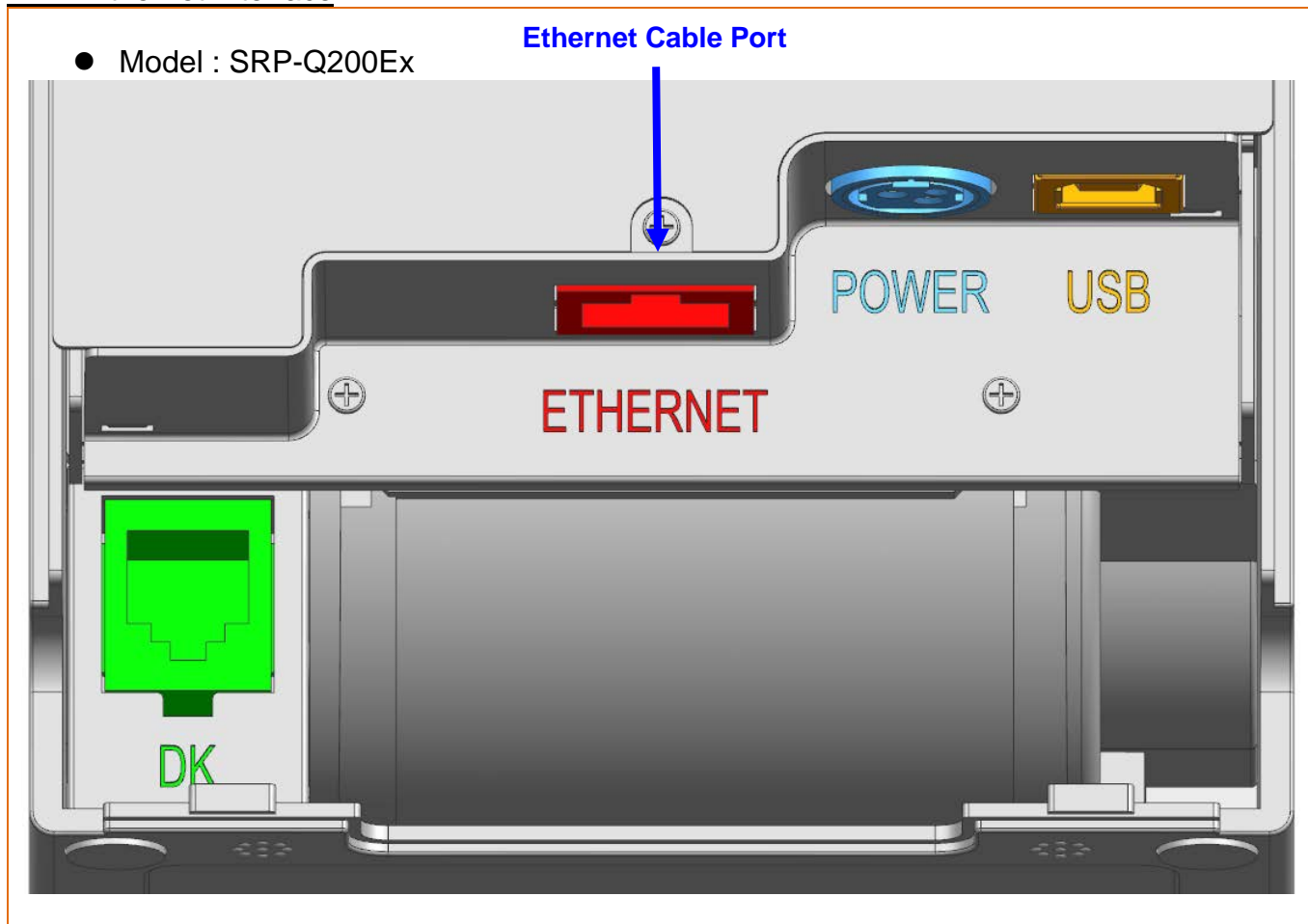

After turning off the power switch of printer, connect and disconnect the communication cable.

1-2-2 Ethernet Interface



| Pin No. | Signal Name | Designation (Color) | Function   |
|---------|-------------|---------------------|------------|
| 1       | TD+         | WHITE ORANGE        | Transmit + |
| 2       | TD-         | ORANGE              | Transmit - |
| 3       | CT          | WHITE GREEN         | Center tap |
| 4       | NC          | BLUE                | -          |
| 5       | NC          | WHITE BLUE          | -          |
| 6       | NC          | GREEN               |            |
| 7       | RD+         | WHITE BROWN         | Receive +  |
| 8       | RD-         | BROWN               | Receive -  |

|  |  |
|--|--|
|  <b>Note</b>    | - Information such as IP and Mac can be found by operating the function key.<br>- Refer to the utility and network connection manual for Interface connection information. |
|  <b>Caution</b> | After turning off the power switch of printer, connect and disconnect the communication cable.   |



1-2-3 Serial Interface (RS-232C)

- Model : SRP-Q200S

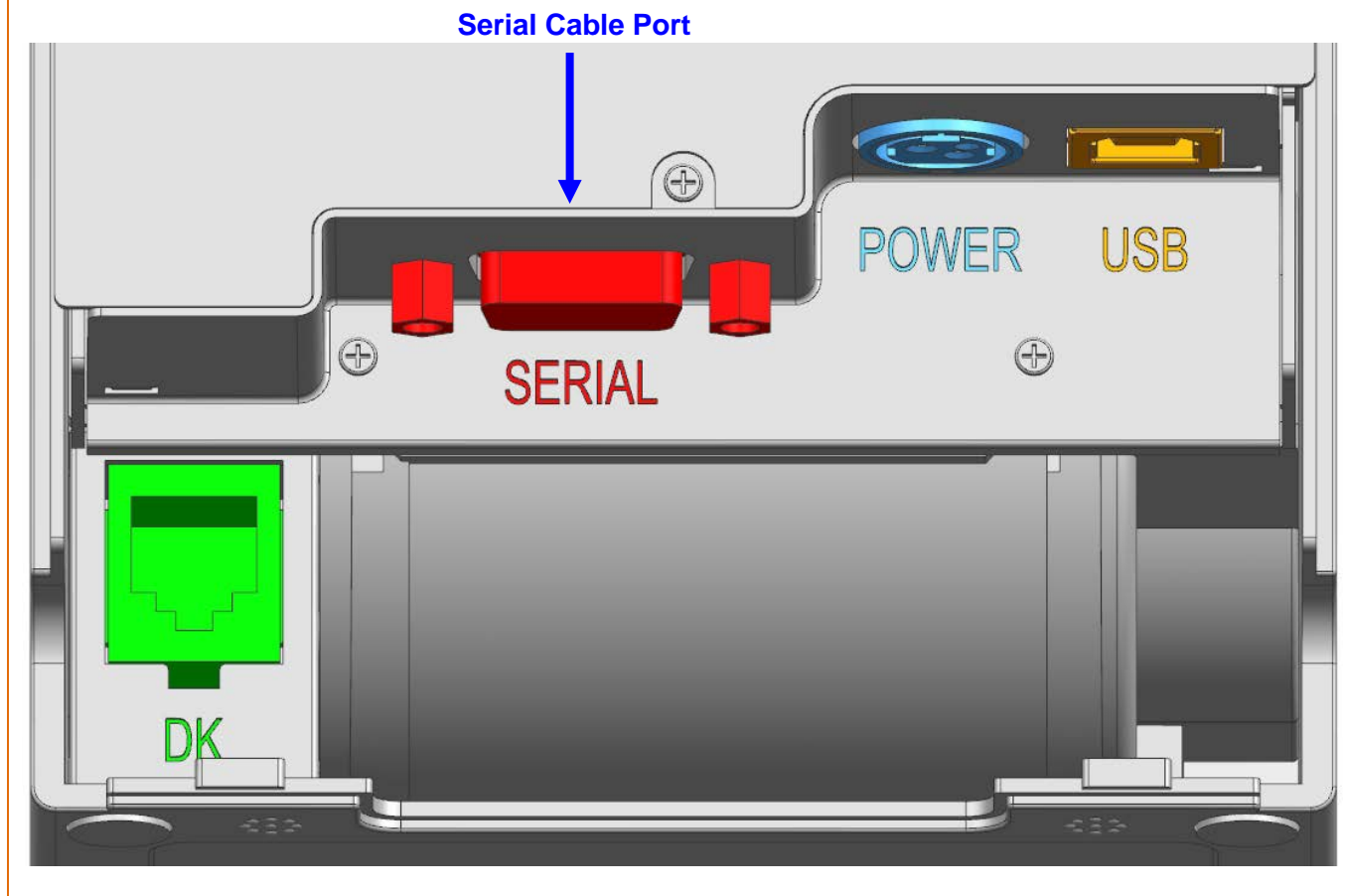

\*Printer side

| Pin No. | Signal Name | Direction | Function      |
|---------|-------------|-----------|---------------|
| 1       | NC          | -         | -             |
| 2       | TxD         | Output    | Transmit Data |
| 3       | RxD         | Input     | Receive Data  |
| 6,8     | RTS         | Output    | Ready To Send |
| 4,7     | CTS         | Input     | Clear To Send |
| 5       | SG          | -         | Signal Ground |
| 9       | NC          | -         | -             |

**⚠ Caution**

After turning off the power switch of printer, connect and disconnect the communication cable.

### 1-2-4 Wireless LAN Interface (Option)

#### 1) Wireless LAN Communication Specifications

| Item      | Specifications |
|-----------|----------------|
| Frequency | 2.4GHz / 5GHz  |
| Protocol  | 802.11 a/b/g/n |

#### 2) Connecting Wireless LAN

Printer can be connected to terminal devices with wireless LAN communication capability (PDA, PC, smartphone, tablet PC, etc.).

**Note**

Refer to the Wireless Wireless LAN Connection Manual for more detailed instructions about how to establish the connection.

### 1-2-5 Bluetooth Interface (Option)

#### 1) Bluetooth Communication Specifications

| Item      | Specifications  |
|-----------|-----------------|
| Frequency | 2.402~2.480 GHz |
| Version   | 4.2             |

#### 2) Bluetooth Connection

Printer can be connected to terminal devices with Bluetooth communication capability (PDA, PC, smartphone, tablet PC, etc.)

**Note**

Refer to the Bluetooth Connection Manual for more detailed instructions about how to establish the connection.

**1-3 Cash drawer Port**

- Connect the cash drawer cable to the drawer kick-out port on the rear side of the printer.

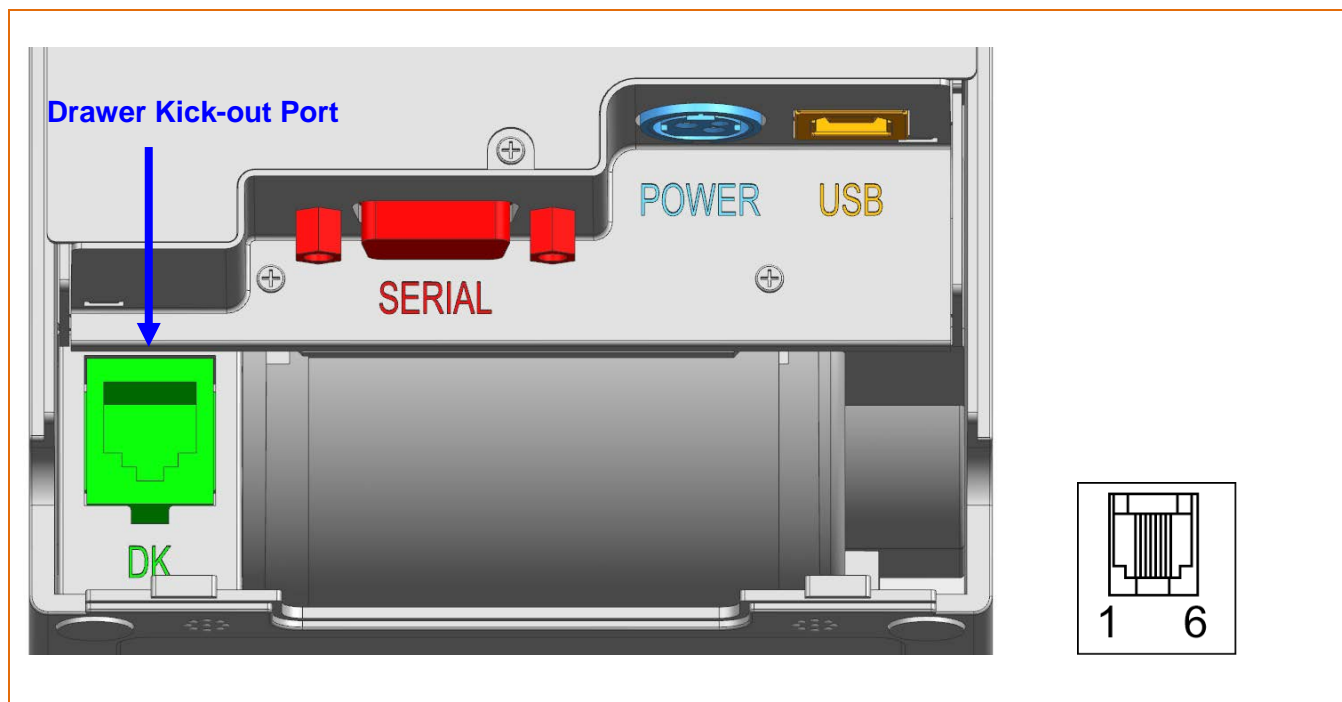

| Pin No. | Signal Name                    | Direction |
|---------|--------------------------------|-----------|
| 1       | Frame Ground                   | -         |
| 2       | Drawer Kick-out Drive Signal 1 | Output    |
| 3       | Drawer Open/Close Signal       | Input     |
| 4       | +24V                           | -         |
| 5       | Drawer Kick-out Drive Signal 2 | Output    |
| 6       | Signal Ground                  | -         |

**⚠ Caution**

- Use a cash drawer that meets the printer specifications. Using a cash drawer that is inappropriate to the specs or using it as a power supply for a separate device may result in damage to the product.
- Do not connect a telephone line to the drawer kick-out port. Otherwise, the telephone line and the computer may be damaged.
- Do not allow a foreign object such as a conductor to touch the drawer kick-out port. This may result in damage to the product
- Make sure to use a cash drawer with an internal coil resistance of  $24 \Omega$  or higher. (The maximum current is 1A.)
- The open signal time for the cash drawer should not exceed 0.8 seconds. After opening the cash drawer, make sure to idle for at least 3.2 seconds (at least 4 times that of the open signal time) before operating it.

**1-4 Connecting Power Supply**

- 1) Make sure the product is turned off before connecting the power supply.
- 2) Connect the power cable with the flat side pointing to the outside of the printer, as shown in the diagram below.

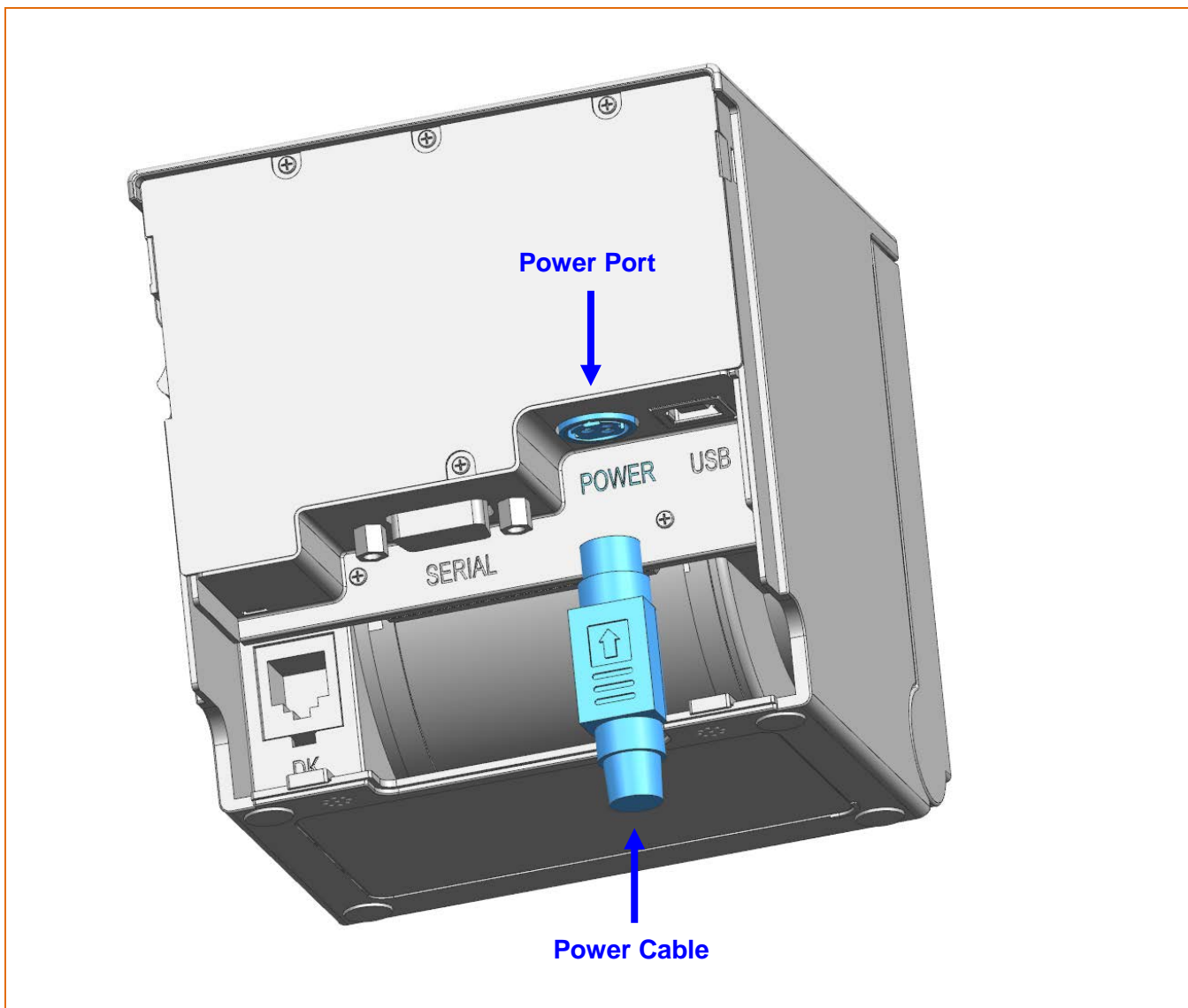

- Only use a power supply provided by Bixelon. Bixelon shall bear no responsibility for damage caused by using a third-party power supply.
- Check the power supply's label to check its electronic specs.
- When removing the power supply, make sure you have a firm grasp of the plug terminal of the power cable and the printer and pull horizontally.
- When connecting or disconnecting power, make sure to remove the power supply from the power outlet before removing.
- Pay attention to the direction in which you insert the power cable.

**⚠ Caution**

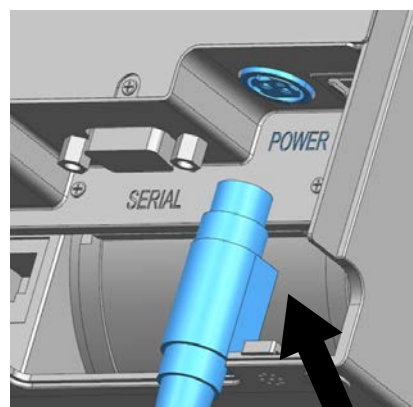
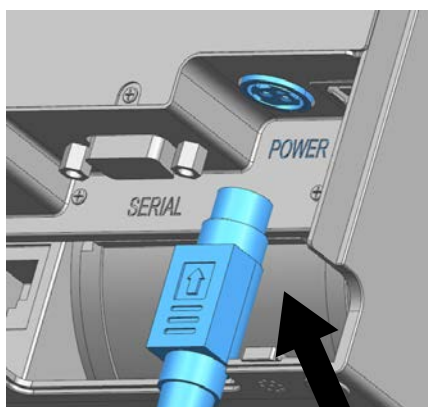



**⚠ Warning**

**Do not connect a voltage out of the specifications of the power supply. It can cause damage to the product or a fire.**

**1-5 Reconfiguration of Printer**

- This product supports virtual memory switch change the use the virtual memory switch utility. Use virtual memory switch management function for self-diagnosis.
- Adjusting print speed and density by virtual memory switch setting

| Level | Print Density | Print Speed | MSW 1-8 | MSW 1-7 | MSW 1-6 | Remark  |
|-------|---------------|-------------|---------|---------|---------|---------|
| 1     | Light         | 250mm/s     | OFF     | OFF     | OFF     | Default |
| 2     | Middle        | 230mm/s     | OFF     | OFF     | ON      |         |
| 3     | Dark          | 200mm/s     | OFF     | ON      | OFF     |         |

|  |  |
|--|--|
|  <b>Note</b>    | - Using the virtual memory switch setting, you can adjust the print speed & print density in three steps.<br>- Refer to the utility and service manual for more information. |
|  <b>Caution</b> | Make sure to turn the printer off and on again after using the virtual memory switch utility to adjust the settings of the product.  |

**1-6 Installing & Replacing Paper**

1) Open the paper roll cover by Pulling the Cover-Open Lever.

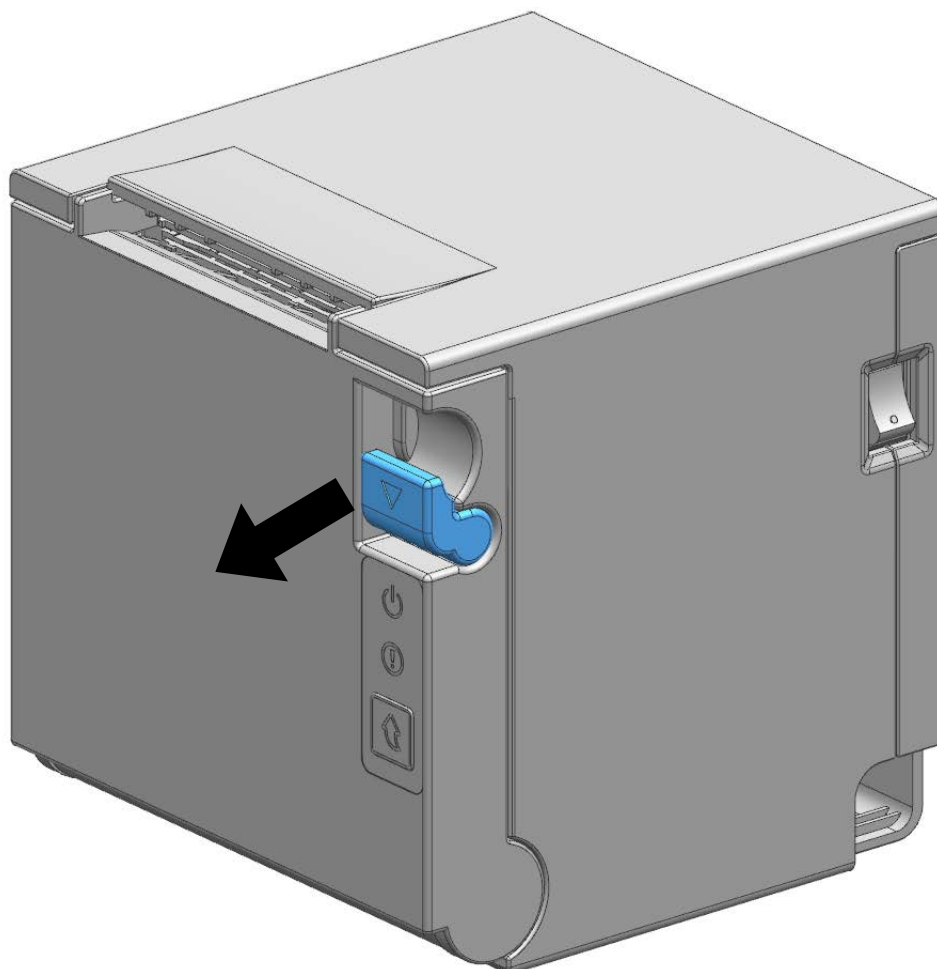

**⚠ Caution**

Do not open the print cover while the printer is operating, otherwise the printer may be damaged.

2) Remove the empty paper roll and replace with a new one as shown in the image.

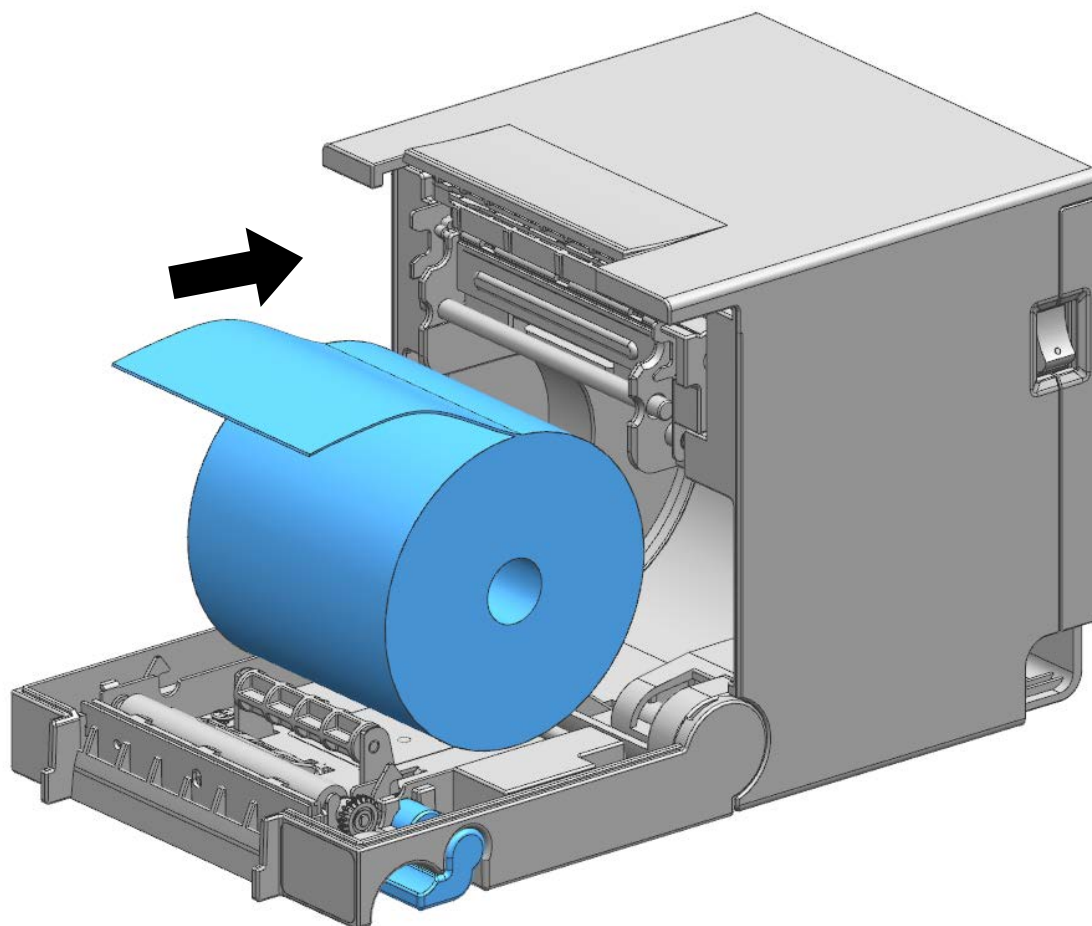

Check the orientation of the roll paper when inserting it into the printer.

 **Caution**

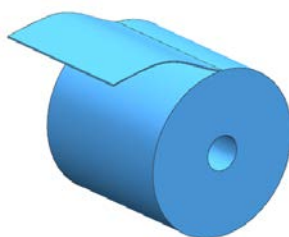

**O**

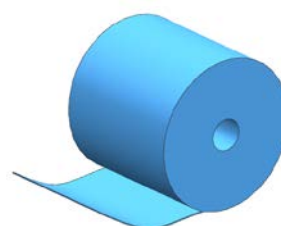

**X**



3) Pull out a small amount of paper as shown in the picture, and close the cover.

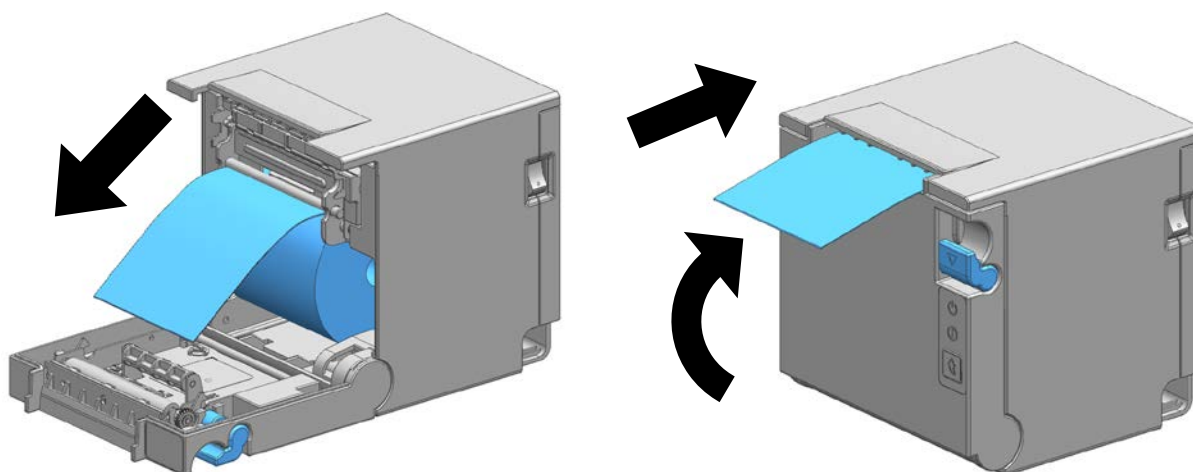

**⚠ Caution**

- When closing the cover, hold down the center of printer cover firmly so that paper roll is loaded correctly.
- Make sure to use the specified paper only.

**1-7 Recommended Papers**

- TF50KS-E (Paper Thickness: 65µm): Nippon Paper Industries Co., Ltd.
- PD 160R (Paper Thickness: 75µm): New Oji Paper Mfg. Co., Ltd.
- P350 (Paper Thickness: 62µm): Kansaki Specialty Paper, Inc. (USA)
- Hansol Thermo 65 (Paper Thickness: 65µm): Hansol Paper Co., Ltd (Korea)



- Use of papers other than those recommended above may damage TPH or degrade the printing quality and our company is not responsible for the damage caused by non-recommended papers.
- If you have to use other products, we recommend that you use papers with a similar level of quality to the recommended ones.

**1-8 Removing Paper Jam**

- 1) When a paper jam occurs, turn the printer off and then back on, open the cover, and remove the jammed paper.
- 2) Turn the power off/on, then close and use the cover.



- Placing your hand above the printer outlet may cause a paper jam.
- If the cover will not open due to a minor paper jam, turning the power ON/OFF will automatically return the blade to its original position.

**1-9 Using Printer Functions**



• **Power (Button)**

- The POWER light is on whenever the printer is on.



• **Error (Indicator Lamp)**

- Red light will be on in various error conditions such as out of paper, cover open, etc.



• **Feed (Button)**

- Press this button to feed the paper out. Hold down this button to feed out the paper continuously.



**Caution**

If the printer does not power on, check that the adapter LED indicates "ON"

## 2. Self-Test

The self-test checks whether the printer has any problems. If the printer does not function properly, contact your dealer. The self-test procedure is as follows:

- 1) Make sure paper roll has been installed properly.
- 2) Turn on the power while holding down the FEED button and the self-test begins.
- 3) The self-test prints the current status of the printer including control ROM version.
- 4) After printing the current printer status, the printer wait for the next step after printing the following lines. (The paper signal light keeps blinking.)

**SELF-TEST PRINTING.**  
**SELECT MODES BY PRESSING FEED BUTTON.**  
**Continuous test printing : Less than 1 second**  
**VMSM Selection : 1 second or more**

- 5) To continue printing, press the FEED button for 1 second or longer to set the memory switch configuration mode.

(1) If you select "Continuous SELF-TEST"

- ① Press the FEED button for less than 1 second, and the printer prints the pre-created character format.
- ② The self-test ends automatically and the printer prints the following text and then cuts the paper.

**\*\*\* COMPLETED \*\*\***

- ③ The printer returns to its normal state immediately after the self-test is finished.

(2) If you select "VMSM Selection"

- ① The following lines will be printed when the VMSM opens.

**\*\* VMSM Selection \*\***

**0 : Exit and reboot printer**

**1 : Print current settings**

**2 : Set Print Density**



**3 : Set Cutting mode**

**4 : Set External Buzzer after cutting**

**5 or more : None**

- ② To execute the above function, operate the FEED button as follows.
- Step 1 (selecting desired item): Press the button as many times as the number displayed before each menu to select the desired setting menu.
  - Step 2 (entering setting item): Press and hold the button for 1 second to apply the selected item.
- ② Execute the "0: Save settings and exit" function to apply the changed settings. When "Save settings and exit" mode is active, the below message will be displayed and the printer will reboot.

**\*\*\* COMPLETED \*\*\***

|  |   |
|--|---|
|  <b>Note</b>    | If you select any items not listed above, the list of "VMSM Selection" will be printed again. Setting the mode will be canceled if no item is selected in Step 1. |
|  <b>Caution</b> | If the "0: Save settings and exit" function is not executed, the setting information is not stored in the printer.  |

### 3. Hexadecimal Dumping

This function allows experienced users to see exactly what data is coming to the printer. This can be useful in finding software problems. When you turn on the hexadecimal dump function, the printer prints all commands and data in hexadecimal format along with a guide section to help you find specific commands.

To use the hexadecimal dump function, follow these steps.

- 1) After making sure that the printer is off, open the cover.
- 2) Turn the printer on, while holding down the FEED button.
- 3) Close the cover, and then the printer enters the hexadecimal dump mode.
- 4) Select the hexadecimal printing function in the mode selection menu to move to the hexadecimal printing mode.
- 5) Run any software program that sends data to the printer.  
The printer will print all the codes it receives in a two-column format.  
The first column contains the hexadecimal codes and the second column gives the ASCII characters that correspond to the codes.

```

1B 21 00 1B 26 02 40 40 40 40  . ! . . & . @ @ @ @
02 0D 1B 44 0A 14 1E 28 28 28  . . . D . . . . ( ( (
00 01 0A 41 0D 42 0A 43 43 43  . . . A . B . C C C

```

- A period (.) is printed for each code that has no ASCII equivalent.
- During the hex dump, all commands are disabled.

- 6) When the printing finishes, turn off the printer.
- 7) Turn on the printer and then the hexadecimal mode is off.



#### **Caution**

Contact the customer center if the printer does not enter hexadecimal printing mode.

## 4. Cleaning Printer

Paper dust inside the printer may lower the print quality. In this case clean the printer as follows:

- 1) Open the printer cover and remove the paper currently in use.
- 2) Residue or contamination of printer head should be wiped out by ethanol or IPA.

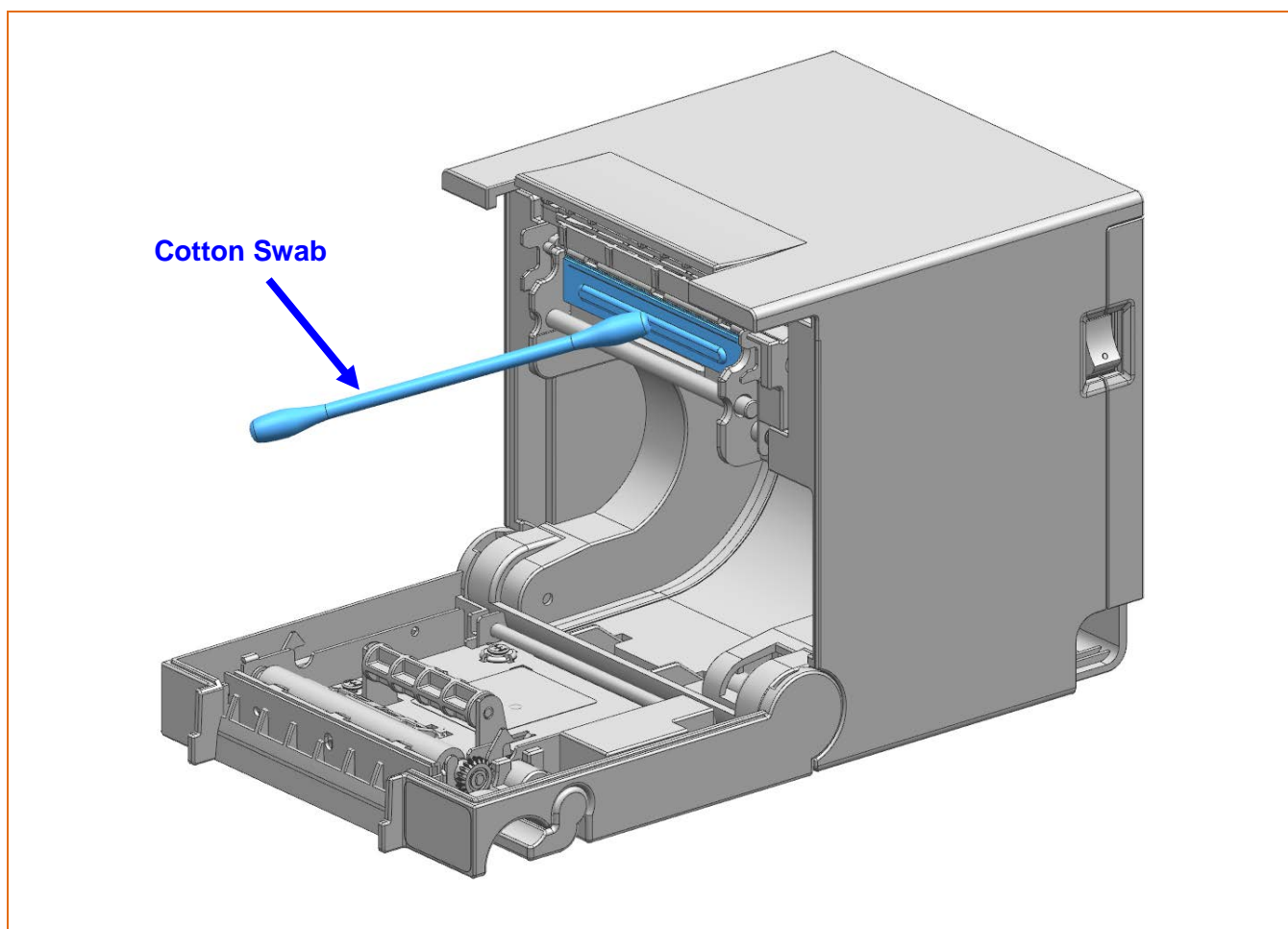

- 3) Clean the paper sensor and paper roller with a cotton swab or a dry cloth.
- 4) Insert a paper roll and close the printer cover.

 **Caution**

When cleaning the printer head, make sure that cleaning solutions such as ethanol or IPA do not penetrate the printer.

 **Warning**

**While the printer is operating, the print-head gets very hot, so turn off the power and let it cool down completely. The hot print-head can cause serious burns.**

## 5. Specifications

|   |  |  |
|---|--|--|
| Printing Method                               | Thermal printing   |  |
| Dot Density                                   | 203 dpi (8dots/mm)   |  |
| Printing Width                                | 2 inches   | 54 mm  |
| Paper Width                                   | 2 inches   | 58.0±0.5 mm  |
| No. of Characters per Line<br>(Default Value) | 36 (Font A) ,48 (Font B, Font C)   |  |
| Printing Speed                                | Max. 250 mm/sec  |  |
| Receiving Buffer Size                         | 4K bytes   |  |
| Interface                                     | Q200S: Serial, USB<br>Q200E: Ethernet, USB<br>Q200EWD: Ethernet, USB, WLAN(2.4GHz,5GHz)<br>Q200EBt: Ethernet, USB, Bluetooth |  |
| Cash Drawer                                   | 2ports with Y-type cable   |  |
| Supply Voltage                                | SMPS<br>Input Voltage  | 100~240 VAC  |
|   | Frequency  | 50/60 Hz   |
|   | SMPS<br>Output Voltage   | 24 VDC   |
| Environment<br>Condition                      | Temperature  | Operating: 0 ~ 40 °C<br>Storage: -20 ~ 60 °C                       |
|   | Humidity   | Operating: 10 ~ 80 % RH<br>Storage: 10 ~ 90 % RH<br>Paper excluded |
| Life Span                                     | Printer Head *)  | 100 Km   |
|   | Auto Cutter  | 1,000,000 cuts   |

\*) The specifications were determined based on operation at normal temperature using designated paper on default settings. They are subject to change depending on temperature or printing level.



### Caution

Printing speed may become slightly slower depending on the data transmission speed and the combination of commands.



## Copyright

© BIXOLON Co., Ltd. All rights reserved.

This user manual and all property of the product are protected under copyright law. It is strictly prohibited to copy, store, and transmit the whole or any part of the manual and any property of the product without the prior written approval of BIXOLON Co., Ltd. The information contained herein is designed only for use with this BIXOLON product. BIXOLON is not responsible for any direct or indirect damages, arising from or related to use of this information.

- The BIXOLON logo is the registered trademark of BIXOLON Co., Ltd.
- All other brand or product names are trademarks of their respective companies or organizations.

BIXOLON maintains ongoing efforts to enhance and upgrade the functions and quality of all our products.

In the following, product specifications and/or user manual content may be changed without prior notice.

## Caution

Some semiconductor devices are easily damaged by static electricity. You should turn the printer "OFF", before you connect or remove the cables on the rear side, in order to guard the printer against the static electricity. If the printer is damaged by the static electricity, you should turn the printer "OFF".

## Compliance information

This device complies with Part 15 of the FCC Rules. Operation is subject to the following two conditions: (1) This device may not cause harmful interference, and (2) This device must accept any interference received, including interference that may cause undesired operation.

This equipment has been tested and found to comply with the limits for a Class A digital device pursuant to Part 15 of the FCC Rules. These limits are designed to provide reasonable protection against harmful interference when the equipment is operated in a commercial environment. This equipment generates uses, and can radiate radio frequency energy and, if not installed and used in accordance with the instruction manual, may cause harmful interference to radio communications. Operation of this equipment in a residential area is likely to cause harmful interference in which case the user will be required to correct the interference at his own expense.

Caution: Exposure to Radio Frequency Radiation.

To comply with FCC RF exposure compliance requirements, a separation distance of at least 20 cm must be maintained between the antenna of this device and all persons.

Caution: Any Changes or modifications not expressly approved by the manufacturer could void the user's authority to operate the equipment.

Class A Digital Device : Wired Device

This Apparatus complies with class "A" limits for radio interference as specified in the Canadian department of communications radio interference regulations.

This Class A digital apparatus complies with Canadian ICES-003.

Appareil numérique de classe A: appareil filaire

Get appareil est conforme aux normes class "A" d'interference radio tel que specifier par ministre canadien des communications dans les reglements d'interference radio.

Cet appareil numérique de la classe A est conform à la norme NMB-003 du Canada.

## Waste Electrical and Electric Equipment (WEEE)



This marking shown on the product or its literature, indicates that it should not be disposed with other household wastes at the end of its working life. To prevent possible harm to the environment or human health from uncontrolled waste disposal, please separate this from other types of wastes and recycle it responsibly to promote the sustainable reuse of material resources. Household users should contact either the retailer where they purchased this product, or their local government office, for details of where and how they can take this item for environmentally safe recycling. Business users should contact their supplier and check the terms and conditions of the purchase contract. This product should not be mixed with other commercial wastes for disposal.

**Revision history**

| Ver. | Date     | Page | Description |
|------|----------|------|-------------|
| 1.00 | 07.08.19 | -    | New         |
|      |          |      |             |
|      |          |      |             |
|      |          |      |             |
|      |          |      |             |
|      |          |      |             |
|      |          |      |             |
|      |          |      |             |
|      |          |      |             |
|      |          |      |             |
|      |          |      |             |
|      |          |      |             |
|      |          |      |             |
|      |          |      |             |
|      |          |      |             |
|      |          |      |             |
|      |          |      |             |
|      |          |      |             |
|      |          |      |             |
|      |          |      |             |
|      |          |      |             |
|      |          |      |             |
|      |          |      |             |
|      |          |      |             |
|      |          |      |             |
|      |          |      |             |
|      |          |      |             |
|      |          |      |             |
|      |          |      |             |
|      |          |      |             |
|      |          |      |             |
|      |          |      |             |