



WARNING & CAUTION

Is described as death, physical injuries, serious financial losses, and damage to data etc. that can be caused to the user.



ПРЕДУПРЕЖДЕНИЕ И ВНИМАНИЕ

Обозначава риск от смърт, физически наранявания, сериозни финансови загуби, увреждане на данни и т.н., които могат да бъдат причинени на потребителя.

Do not connect multiple products to a single or faulty power outlet. Only use grounded power outlets that meet the industry standard. **Noncompliance may cause electric shock or fire.**



Only use authentic products from BIXOLON. **The company will not provide post-sale support for damaged or other quality issues that any fake (or refurbished) products may incur.**



Не свързвайте няколко продукта към един-единствен или повреден електрически контакт. Използвайте само заземени електрически контакти, които отговарят на стандартите. **Неспазването на това предупреждение може да доведе до токов удар или пожар.**



Използвайте само оригинални продукти на BIXOLON. **Компанията не осигурява гаранционен ремонт на повреди или други дефекти, които могат да възникнат при употреба на фалшиви (или възстановени) продукти.**



Do not excessively bend or strain the power cord. Securely push the power cord all the way into the power outlet lest it remain loose. Make sure to hold the cord tight when separating it from the power outlet. Do not remove the power cord while the product is in use. **Noncompliance may cause electric shock or fire.**



Keep small accessories or other packaging materials away from young children. Beware: choking hazard. **Mishandling the product may incur injuries which may require seeking urgent medical attention.**



Не огъвайте и не опъвайте прекомерно захранващия кабел. Натиснете захранващия кабел докрай в контакта, за да не остане разхлабен. Избягвайте стабилно щещела, когато го изваждате от контакта. Не изключайте захранващия кабел, докато продуктът работи. **Неспазването на това предупреждение може да доведе до токов удар или пожар.**



Дръжте малките аксесоари или други опаковъчни материали далеч от малки деца. Внимание: опасност от задушаване. **Неправилното боравене с продукта може да доведе до наранявания, които да наложат спешна медицинска помощ.**



Keep excessive liquids away from the power cord and outlet. If matter is smeared onto the power cords, wipe with a dry cloth. **Noncompliance may cause electric shock or fire.**



Do not allow the product to be damaged by heavy objects. **Noncompliance may cause electric shock or fire.**



Съхранявайте течностите далеч от захранващия кабел и контакта. Ако върху захранващите кабели е попаднала вода, избършете я със суха кърпа. **Неспазването на това предупреждение може да доведе до токов удар или пожар.**



Не допускайте продуктът да бъде повреден от тежки предмети. **Неспазването на това предупреждение може да доведе до токов удар или пожар.**



If the product emits a strange sound, burning smell, smoke, turn off the power immediately and unplug the power cord. If the product is dropped or its exterior is damaged, turn off the power immediately and unplug the power cord. Do not subject the product to shock. **This could cause damage to the product or a fire.**



Install the product in a well-ventilated area by keeping it a certain distance from the wall. Installing the product in certain environments which are prone to excessive dust, moisture and temperature fluctuations or putting the product under extreme use may cause damage to the printer. **An increase in Internal temperature may start a fire. Be sure to contact the place of purchase if you are unsure of product placement.**



Ако продуктът издава странен звук, мириса на изгоряло или дим, незабавно изключете захранването и извадете щещела от контакта. Ако изгунете продукта или външната му част бъде повредена, незабавно изключете захранването и извадете щещела от контакта. Не подлагайте продукта на сътресения. **Това може да доведе до повреда на продукта или до пожар.**



Инсталирайте продукта на място с добра вентилация и на известно разстояние от стената. Инсталирането на принтера в среда, в която има вероятност от прекомерно запрашаване, влага и колебания в температурата, или подлагането на принтера на предельно интензивна употреба може да доведе до повреда. Повишаването на вътрешната температура може да предизвика пожар. **Свържете се с търговеца, от който сте закупили продукта, ако не сте сигурни как да разположите продукта.**

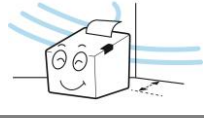

Install the product in a fixed location to prevent it from tipping over. When moving the product, turn off the power and disconnect all connected cables, including the power cord. **As it may damage the product.**



Never independently disassemble, repair, or modify the product as the warranty will become invalid. **When repair is necessary, contact the original place of purchase.**



Поставете продукта на фиксирано място, за да предотвратите преобръщането му. Когато премествате продукта, изключете захранването и изключете всички свързани кабели, включително и захранващия кабел. **В противен случай продуктът може да бъде повреден.**



Никога не разглобявайте, не ремонтирайте и не модифицирайте продукта самостоятелно, тъй като това ще анулира гаранцията. **При необходимост от ремонт се обрънете към търговеца, от който сте закупили продукта.**



Do not let any foreign substances enter the product. Do not place heavy objects, liquids, or metals on the product. **This could cause damage to the product or a fire.**



If there is a problem with the product, please contact the original place of purchase or through BIXOLON website's product repair page www.bixolon.com.



Не допускайте в продукта да попадат чужди вещества. Не поставяйте тежки предмети, течности или метали върху продукта. **Това може да доведе до повреда на продукта или до пожар.**







Ако възникне проблем с продукта, се свържете с търговеца, от който сте го закупили или се свържете с нас чрез страницата за ремонт на продукти на уебсайта на BIXOLON (www.bixolon.com).



English

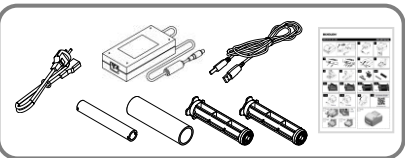

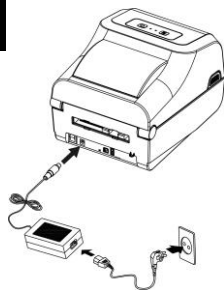
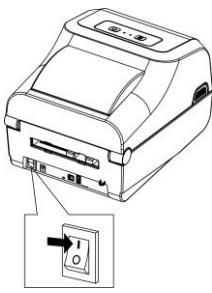
Bulgarian

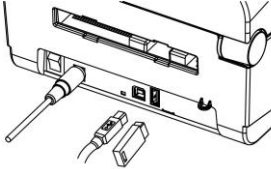
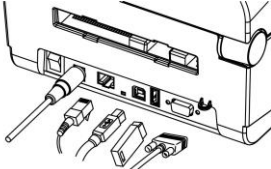
 <p>Standardni model</p>  <p>LCD model</p>	 <p>Mogućnost</p> 	<p>1</p> 	<p>2</p> 
--	--	---	--

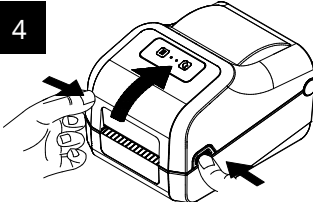
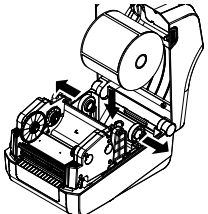
<p>3</p> 	
--	---

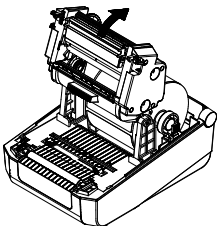
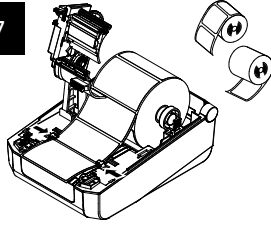
<p>4</p> 	<p>5</p> 
---	--

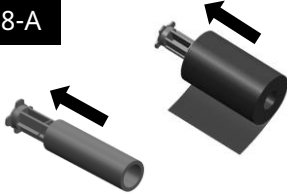

<p>6</p> 	<p>7</p> 
---	---

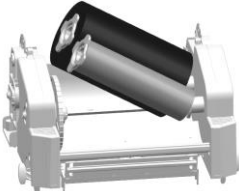
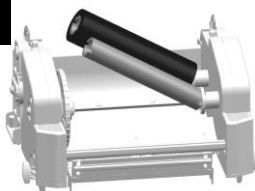
<p>8-A</p> 	<p>8-B</p> 
--	---

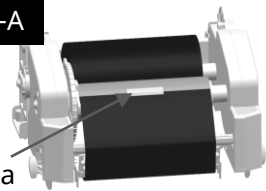
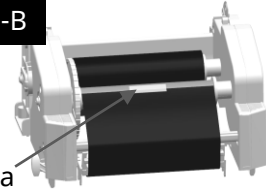
<p>9-A</p> 	<p>9-B</p> 
--	--

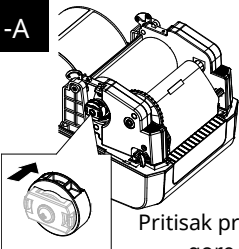
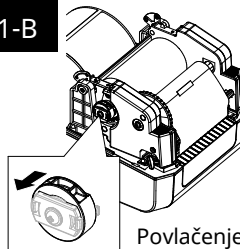
<p>10-A</p>  <p>Traka</p>	<p>10-B</p>  <p>Traka</p>
---	--

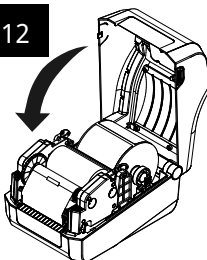
<p>11-A</p>  <p>Pritisak prema gore</p>	<p>11-B</p>  <p>Povlačenje dolje</p>
--	---

<p>12</p> 	<p>13</p> <p>Za preuzimanje više informacija posjetite web mjesto BIXOLON.</p> 
--	--

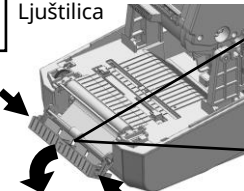
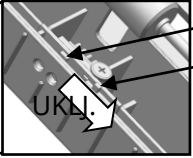
<p>1</p> <p>Ljuštilica</p> 	<p>LED</p> <p>Prekidač</p> <p>UKL.</p> 
--	--

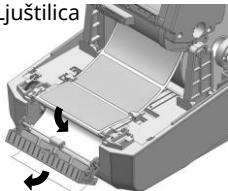
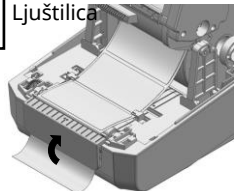
<p>2</p> <p>Ljuštilica</p> 	<p>3</p> <p>Ljuštilica</p> 
---	--

<p>4</p> <p>Ljuštilica</p> 
--

<p>1</p> <p>Rezač</p> 

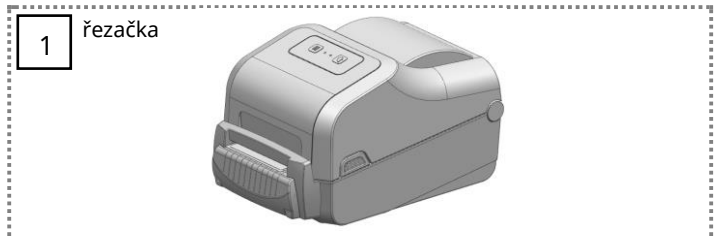
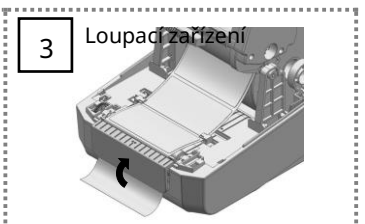
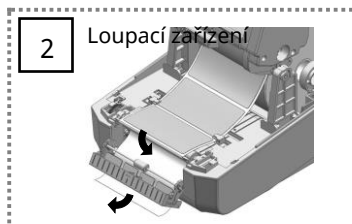
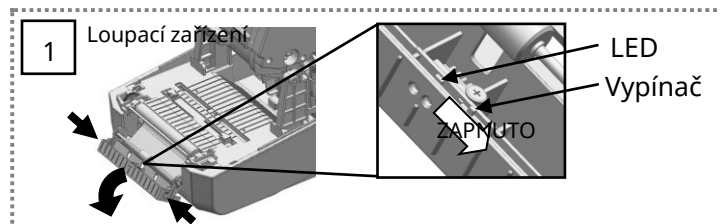
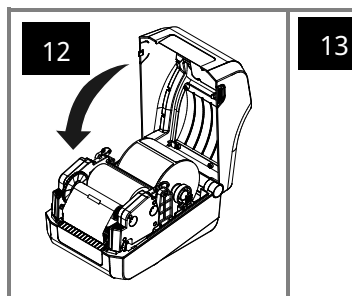
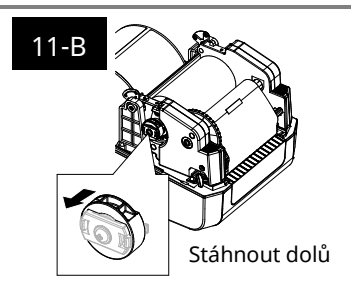
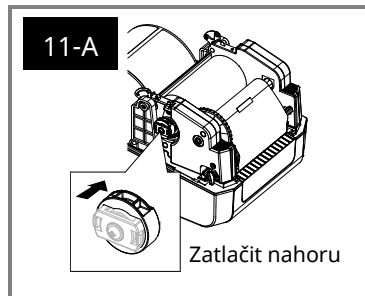
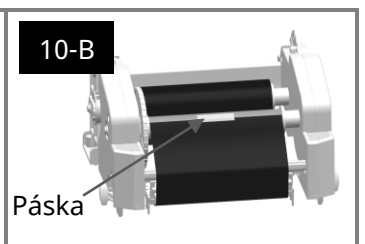
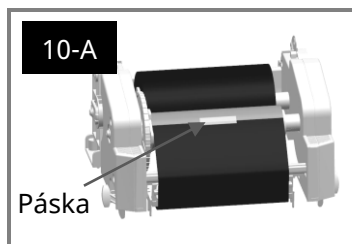
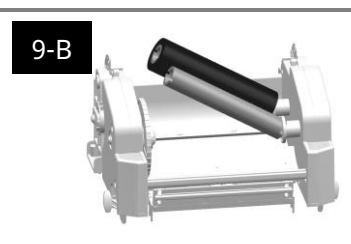
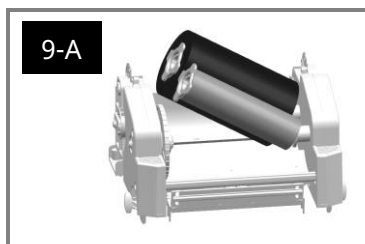
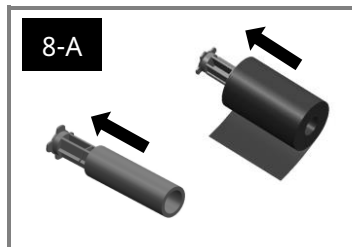
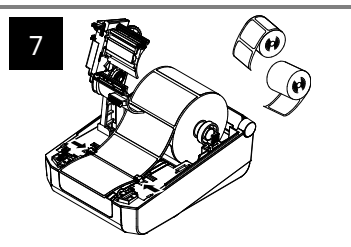
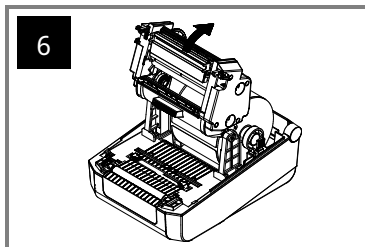
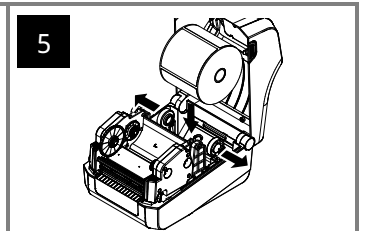
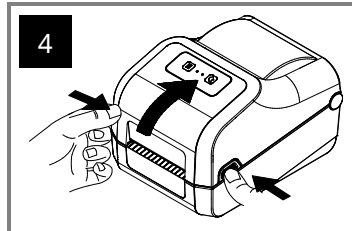
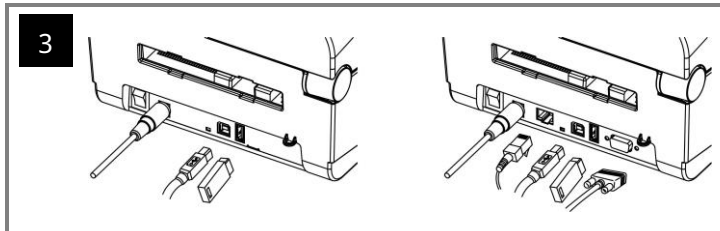
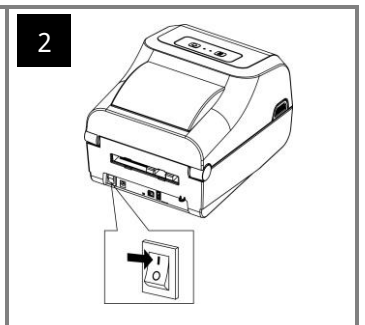
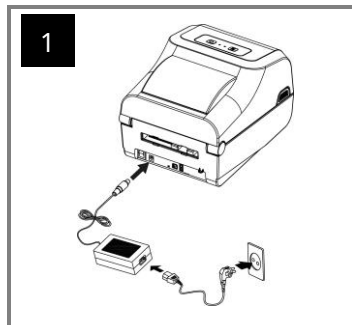
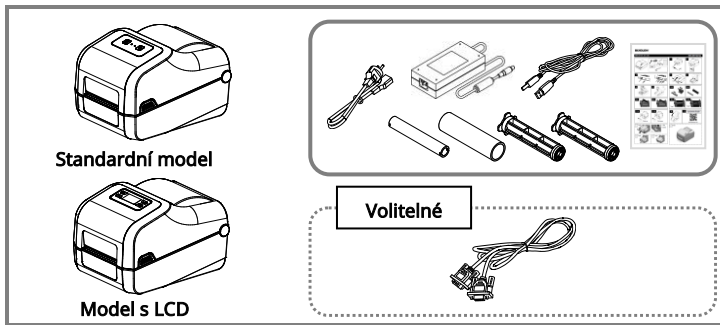



UPOZORENJE I OPREZ

Opisuje se kao smrt, fizičke ozljede, ozbiljni finansijski gubici i oštećenje podataka itd. koji se mogu prouzročiti korisniku.

Ne spajajte više proizvoda na jednu ili neispravnu utičnicu. Koristite samo uzemljene utičnice koje zadovoljavaju industrijski standard. **Nesukladnost može uzrokovati strujni udar ili požar.**



Nemojte pretjerano savijati ili zatezati kabel za napajanje. Čvrsto gurnite kabel za napajanje do kraja u utičnicu kako ne bi ostao labav. Pazite da čvrsto držite kabel kada ga odvajate od utičnice. Nemojte uklanjati kabel za napajanje dok je proizvod u uporabi. **Nesukladnost može uzrokovati strujni udar ili požar.**



Držite prekomjerne tekućine podalje od kabela za napajanje i utičnice. Ako je mrlja razmazana po kablomima za napajanje, obrišite ih suhom krpom. **Nesukladnost može uzrokovati strujni udar ili požar.**

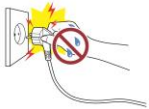

Ako proizvod emitira neobičan zvuk, miris paljeline ili dim, odmah isključite napajanje i izvucite kabel za napajanje. Ako proizvod padne ili mu se vanjski dio ošteti, odmah isključite napajanje i izvucite kabel za napajanje. Ne izlažite proizvod udarcima. **To bi moglo uzrokovati oštećenje proizvoda ili požar.**



Postavite proizvod na fiksno mjesto kako biste spriječili njegovo prevrtanje. Kada premještate proizvod, isključite napajanje i odspojite sve spojene kabele, uključujući kabel za napajanje. **Naime, može oštetiti proizvod.**



Ne dopuštajte da strane stvari uđu u proizvod. Ne stavljajte teške predmete, tekućine ili metale na proizvod. **To bi moglo uzrokovati oštećenje proizvoda ili požar.**



Koristite samo autentične proizvode BIXOLON. **Tvrtka neće pružati podršku nakon prodaje za oštećene ili druge probleme s kvalitetom koje mogu izazvati bilo koji lažni (ili obnovljeni) proizvod.**



Držite male dodatke ili druge materijale za pakiranje dalje od male djece. Oprez: opasnost od gušenja. **Pogrešno rukovanje proizvodom može dovesti do ozljeda koje mogu zahtijevati hitnu liječničku pomoć.**



Nemojte dopustiti da se proizvod ošteti teškim predmetima. **Nesukladnost može uzrokovati strujni udar ili požar.**



Instalirajte proizvod u dobro prozračenom prostoru održavajući ga na određenom mjestu udaljenosti od zida. Ugradnja proizvoda u određena okruženja koja su sklona prekomjernoj prašini, vlazi i temperaturne fluktuacije ili stavljanje proizvoda u ekstremnu uporabu može oštetiti pisar. Povećanje unutarnje temperature može izazvati požar. **Obavezno kontaktirajte mjesto kupnje ako niste sigurni u plasman proizvoda.**



Nikada nemojte samostalno rastavljati, popravljati ili modificirati proizvod jer će jamstvo prestati vrijediti. **Ako je potreban popravak, obratite se izvornom mjestu kupnje.**



Ako postoji problem s proizvodom, obratite se Izvornom mjestu kupnje ili putem web mjesta za popravak proizvoda BIXOLON (www.bixolon.com).



VAROVÁNÍ A UPOZORNĚNÍ

Opisuje se jako smrt, fizičke zranění, vážné finanční ztráty a poškození dat atd., které mohou být způsobeny uživateli.

Nepřipojujte více produktů do jedné nebo vadné zásuvky. Používejte pouze uzemněné zásuvky, které splňují normy daného odvětví. **Nedodržení může způsobit úraz elektrickým proudem nebo požár.**



Napájecí kabel přitlačte neohýbejte ani nenamáhejte. Napájecí kabel bezpečně do zásuvky zasuněte až na doraz, aby nezástal volný. Při odpojování kabelu od zásuvky kabel pevně držte. Neodpojujte napájecí kabel, pokud je produkt v provozu. **Nedodržení může způsobit úraz elektrickým proudem nebo požár.**



Tekutiny uchovávejte mimo dosah napájecího kabelu a zásuvky. Pokud se na napájecích kabelech objeví nečistoty, otřete je suchým hadříkem. **Nedodržení může způsobit úraz elektrickým proudem nebo požár.**



Pokud produkt vydává podivný zvuk, zápach spáleniny nebo se z něj kouří, okamžitě vypněte napájení a odpojte napájecí kabel. Pokud produkt upadne nebo dojde k poškození jeho vnější části, okamžitě vypněte napájení a odpojte napájecí kabel. Nevystavujte produkt nárazům. **Mohlo by to způsobit poškození produktu nebo požár.**



Produkt instalujte na pevné místo, aby se nepřevrtil. Při přenesení produktu vypněte napájení a odpojte všechny připojené kabely včetně napájecího kabelu. **Mohlo by dojít k poškození produktu.**



Do produktu nesmí proniknout žádné cizí látky. Nepokládejte na produkt těžké předměty, tekutiny ani kovy. **Mohlo by to způsobit poškození produktu nebo požár.**



Používejte pouze autentické produkty společnosti BIXOLON. **Společnost neposkytuje podporu po prodeji v případě poškození nebo jiných problémů s kvalitou, které se mohou vyskytnout u padělaných (nebo repasovaných) výrobků.**



Drobné příslušenství a obalové materiály uchovávejte mimo dosah malých dětí. Hrozí nebezpečí udušení. **Při nesprávné manipulaci s produktem může dojít k poranění, které může vyžadovat pomoc lékaře.**



Nedovolte, aby došlo k poškození produktu těžkými předměty. **Nedodržení může způsobit úraz elektrickým proudem nebo požár.**



Produkt instalujte na dobře větraném místě v dostatečné vzdálenosti od stěny. Instalace produktu v určitých prostředích, která jsou náchylná k nadměrnému výskytu prachu, vlhkosti a teplotních výkyvů, nebo vystavení produktu extrémnímu používání může způsobit poškození tiskárny. Zvýšení vnitřní teploty může způsobit požár. **Pokud si nejste jisti umístěním produktu, zeptejte se v místě jeho zakoupení.**



Nikdy produkt sami nerozebírejte, neopravujte ani neupravujte, protože by tím zanikla záruka. **V případě nutnosti opravy se obraťte na místo, kde jste jej zakoupili.**



Pokud se vyskytne problém s produktem, obraťte se na místo, kde jste jej zakoupili, nebo na stránku pro opravu produktů na webových stránkách společnosti BIXOLON (www.bixolon.com).



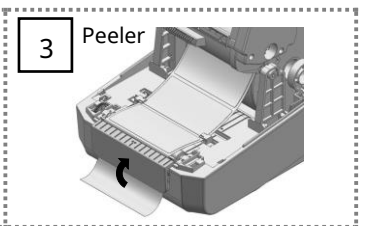
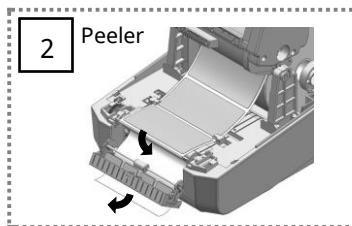
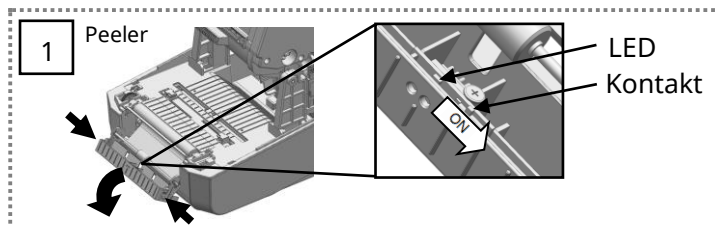
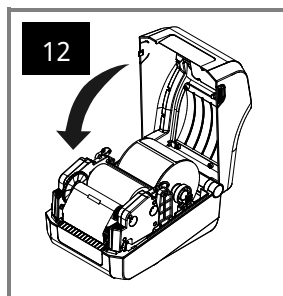
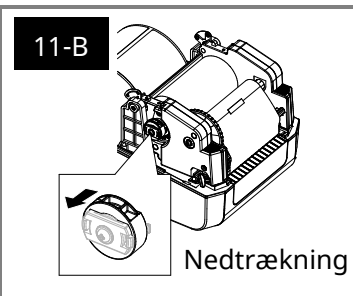
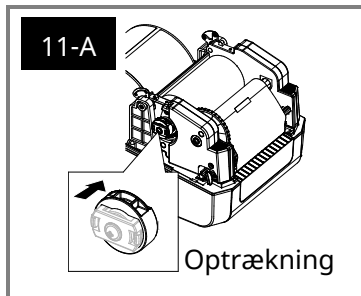
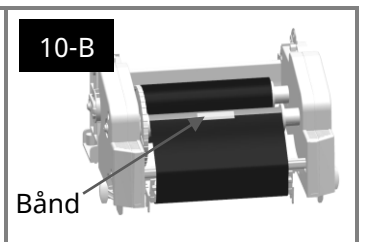
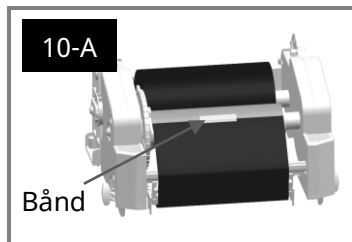
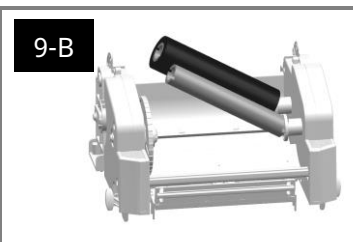
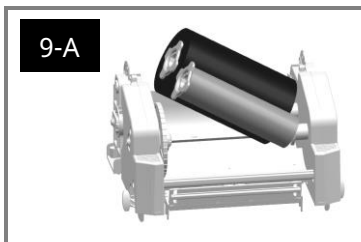
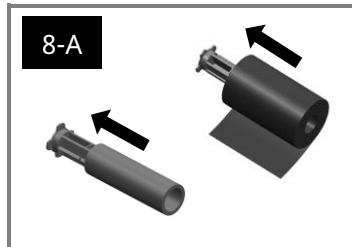
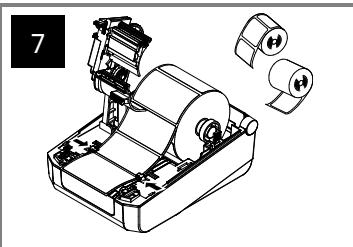
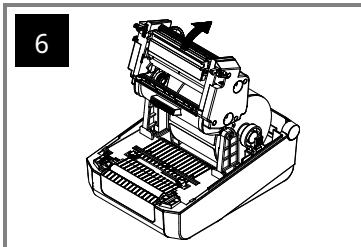
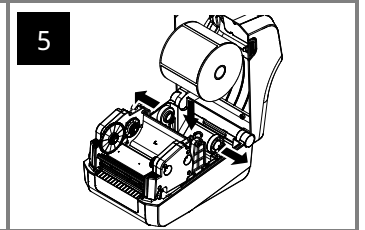
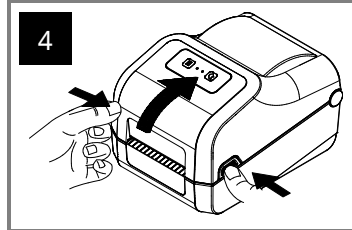
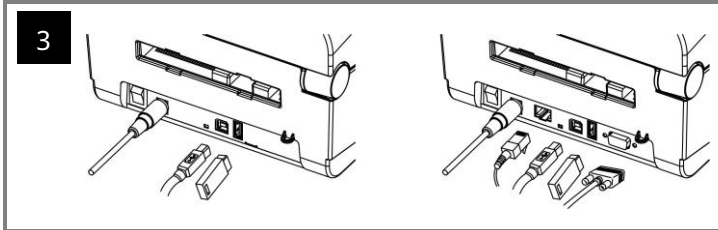
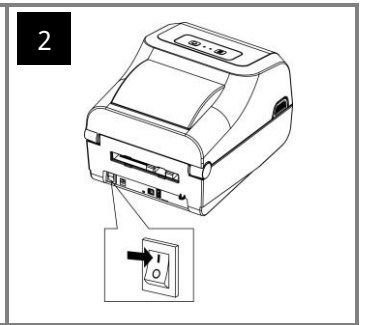
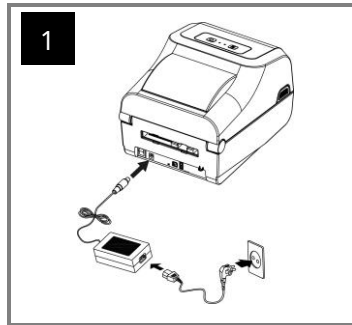
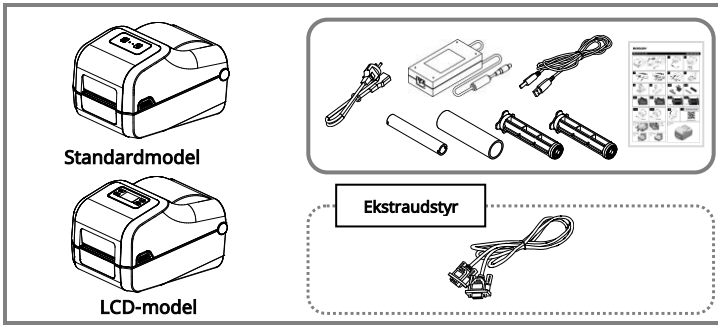

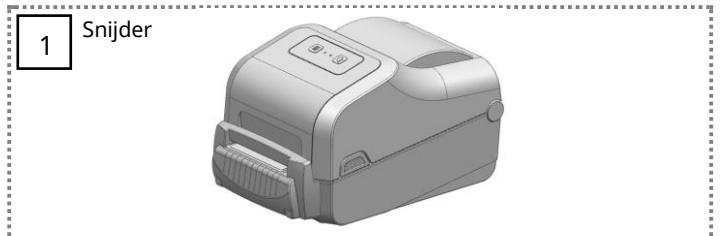
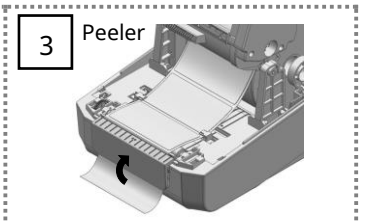
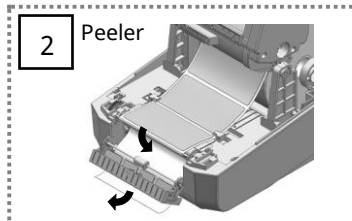
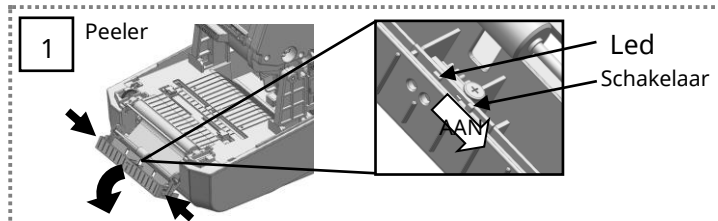
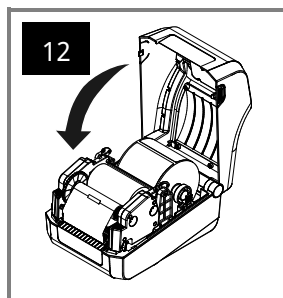
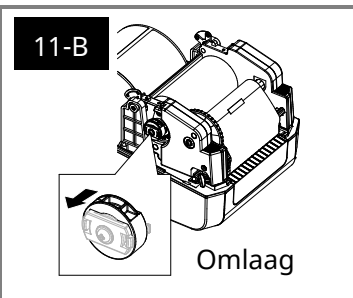
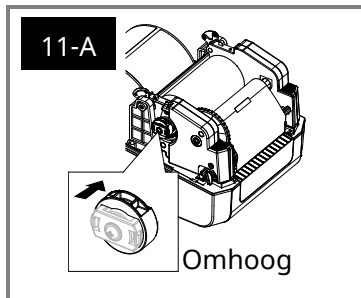
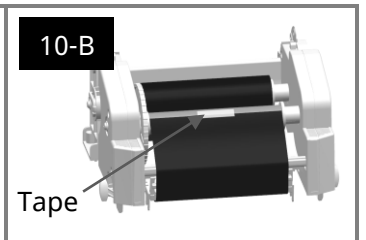
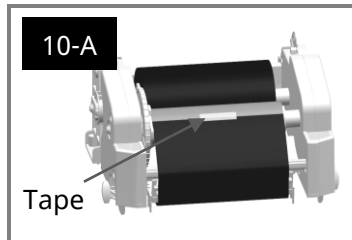
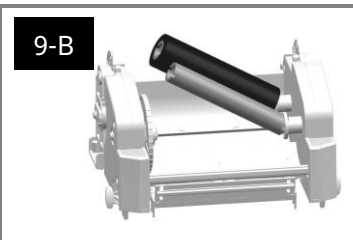
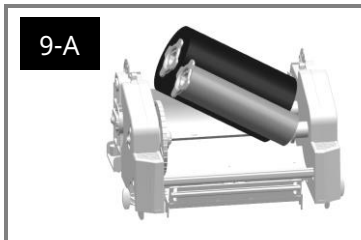
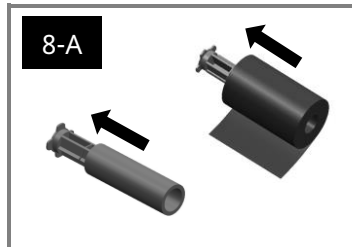
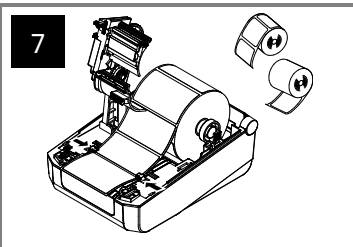
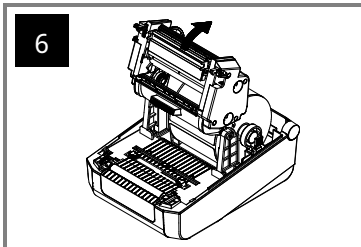
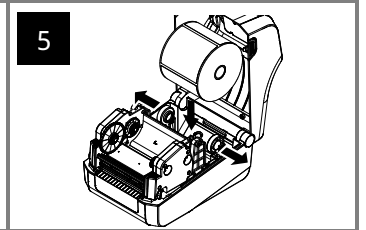
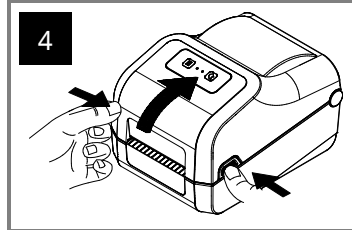
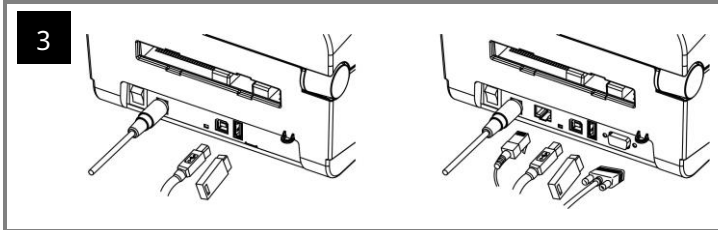
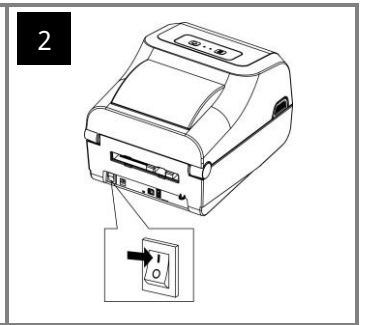
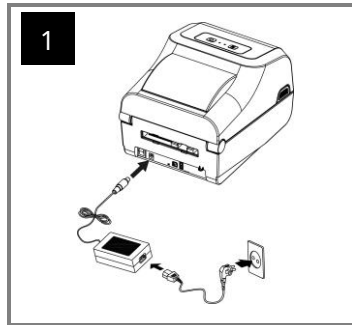
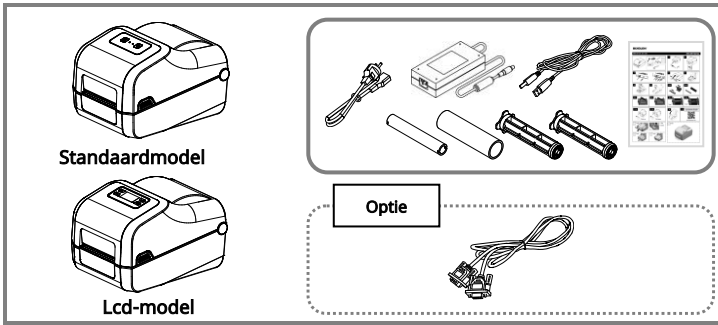



ADVARSEL OG FORSIGTIGHED

Beskrives som død, fysiske skader, alvorlige økonomiske tab og beskadigelse af data m.m., der kan påføres brugerne.



WAARSCHUWINGEN

Wordt beschreven als overlijden, lichamelijk letsel, ernstige financiële verliezen en schade aan gegevens enz. die aan de gebruiker kunnen worden toegebracht.

Tilslut ikke flere produkter til en enkelt eller defekt stikkontakt. Brug kun stikkontakter med jordforbindelse, der opfylder industristandarden. **Manglende overholdelse kan forårsage elektrisk stød eller brand.**



Brug kun autentiske produkter fra BIXOLON. **Virksomheden yder ikke support efter salg ved skade eller andre kvalitetsproblemer, som eventuelle falske (eller renoverede) produkter kan pådrage sig.**



Sluit niet meerdere producten aan op één stopcontact of op een defect stopcontact. Gebruik alleen geaarde stopcontacten die voldoen aan de industriestandaard. **Als u zich niet aan de voorschriften houdt, kan dit leiden tot elektrische schokken of brand.**



Gebruik alleen authentieke producten van BIXOLON. **Het bedrijf biedt geen ondersteuning na de verkoop voor beschadigde of andere kwaliteitsproblemen die kunnen optreden bij namaakproducten (of gefabriceerde) producten.**



Undgå at bøje eller belaste strømkablet for meget. Skub strømkablet helt ind i stikkontakten, så det ikke sidder løst. Sørg for at holde godt fast i kablet, når du tager det ud af stikkontakten. Fjern ikke strømkablet, mens produktet er i brug. **Manglende overholdelse kan forårsage elektrisk stød eller brand.**



Hold små tilbehør eller andet emballagemateriale væk fra små børn. Pas på: fare for kvælning. **Forkert håndtering af produktet kan medføre skader, som kan kræve akut lægehjælp.**



Buig of belast het netsnoer niet te veel. Zorg dat de stekker correct in het stopcontact zit. Trek altijd aan de stekker en niet aan het snoer als u de stekker uit het stopcontact wilt halen. Verwijder het netsnoer niet terwijl het product in gebruik is. **Als u zich niet aan de voorschriften houdt, kan dit leiden tot elektrische schokken of brand.**



Houd kleine accessoires of ander verpakkingsmateriaal buiten het bereik van jonge kinderen. Let op: verstikkingsgevaar. **Verkeerd gebruik van het product kan leiden tot verwondingen waarvoor dringend medische hulp nodig is.**



Hold større mængder væske væk fra strømkablet og stikkontakten. Hvis der er smurt stof på strømkablerne, skal du tørre dem af med en tør klud. **Manglende overholdelse kan forårsage elektrisk stød eller brand.**



Lad ikke produktet blive beskadiget af tunge genstande. **Manglende overholdelse kan forårsage elektrisk stød eller brand.**



Houd vloeistoffen uit de buurt van het netsnoer en het stopcontact. Reinig het netsnoer met een droge doek. **Als u zich niet aan de voorschriften houdt, kan dit leiden tot elektrische schokken of brand.**



Zorg ervoor dat het product niet wordt beschadigd door zware voorwerpen. **Als u zich niet aan de voorschriften houdt, kan dit leiden tot elektrische schokken of brand.**



Hvis produktet udsender en mærkelig lyd, en brændende lugt eller røg, skal du straks slukke for strømmen og tage strømkablet ud. Hvis produktet tabes eller beskadiges udvendigt, skal du straks slukke for strømmen og trække strømkablet ud. Udsæt ikke produktet for stød. **Dette kan medføre skader på produktet eller brand.**

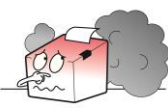

Installer produktet i et godt ventileret område ved at holde det i en vis afstand fra væggen. Hvis produktet installeres i visse miljøer, der er udsat for meget støv, fugt og temperaturudsving, eller hvis produktet udsættes for ekstrem brug kan printerne blive beskadiget. En stigning i den indre temperatur kan starte en brand. **Sørg for at kontakte købsstedet for, hvis du er i tvivl om produktets placering.**



Als het product een vreemd geluid, een brandgeur of rook afgeeft, schakel dan onmiddellijk de stroom uit en trek de stekker uit het stopcontact. Als het product valt of de buitenkant beschadigd is, schakel dan onmiddellijk de stroom uit en trek de stekker uit het stopcontact. **Stel het product niet bloot aan schokken. Dit kan schade aan het product of brand veroorzaken.**



Installeer het product in een goed geventileerde ruimte. Houd altijd enige afstand tot de muur. Als u het product installeert in bepaalde omgevingen die gevoelig zijn voor overmatig stof, vocht en temperatuurschommelingen of wanneer het product extreem wordt gebruikt, kan de printer beschadigd raken. Een verhoging van de binnentemperatuur kan brand veroorzaken. **Neem contact op met de plaats van aankoop als u niet zeker bent van de plaatsing van het product.**



Installer produktet på et fast sted for at forhindre, at det vælter. Når du flytter produktet, skal du slukke for strømmen og frakoble alle tilsluttede kabler, inklusive strømkablet. **Da det kan beskadige produktet.**



Du må aldrig selv adskille, reparere eller ændre produktet, da garantien da vil blive ugyldig. **Hvis reparation er nødvendig, skal du kontakte det oprindelige købssted.**



Installeer het product op een vaste locatie om te voorkomen dat het omvalt. Schakel tijdens het verplaatsen van het product de stroom uit en koppel alle aangesloten kabels los, inclusief het netsnoer. **Kabels kunnen tijdens het transport of de verplaatsing beschadigd raken.**



Demonteer, repareer of wijzig het product nooit zelfstandig, aangezien anders de garantie vervalt. **Als reparatie nodig is, neem dan contact op met de oorspronkelijke plaats van aankoop.**



Lad ikke fremmede substanser komme ind i produktet. Anbring ikke tunge genstande, væsker eller metaller på produktet. **Dette kan medføre skader på produktet eller brand.**



Hvis der er et problem med produktet, bedes du kontakte det oprindelige købssted eller besøge BIXOLONs hjemmeside på produktreparationssiden (www.bixolon.com).



Zorg ervoor dat er geen vreemde stoffen in het product terechtkomen. Plaats geen zware voorwerpen, vloeistoffen of metalen op het product. **Dit kan schade aan het product of brand veroorzaken.**



Als er een probleem is met het product, neem dan contact op met de oorspronkelijke plaats van aankoop of via de productreparatiepagina van de BIXOLON-website (www.bixolon.com).



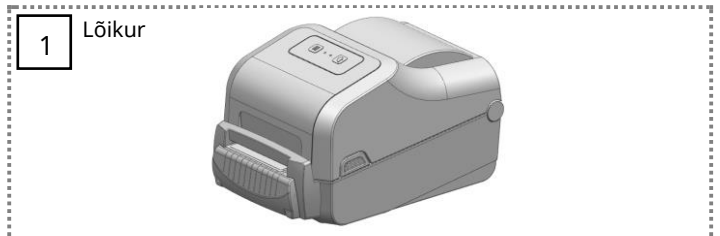
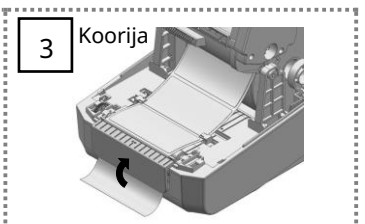
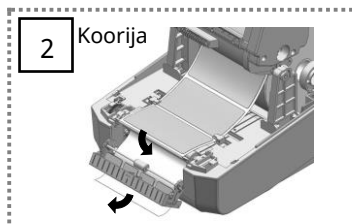
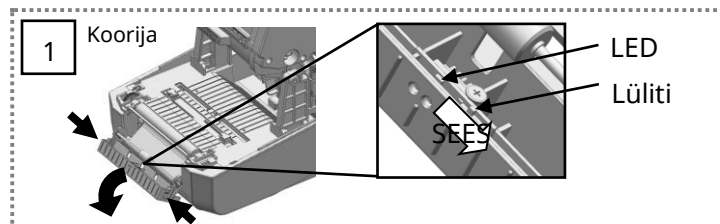
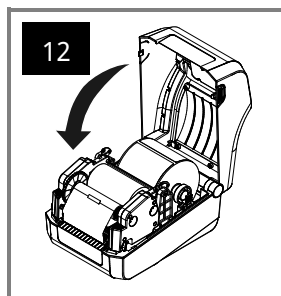
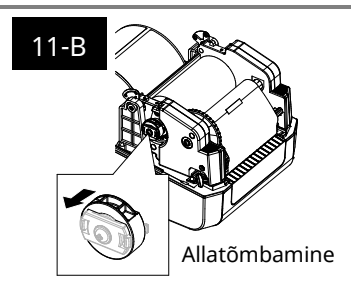
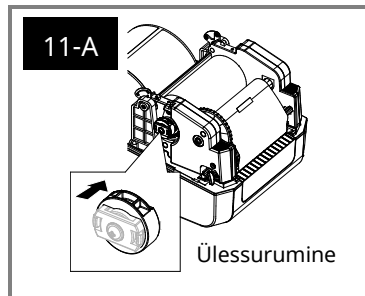
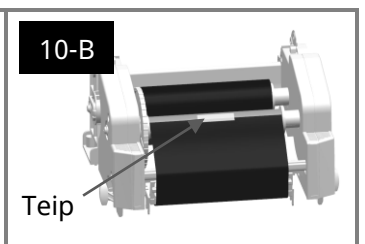
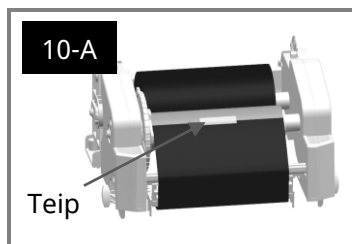
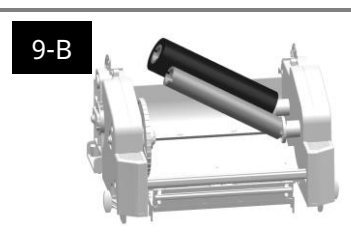
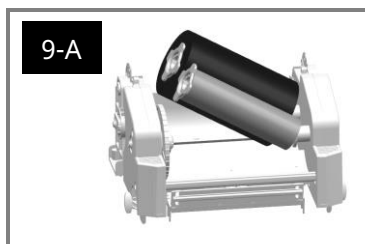
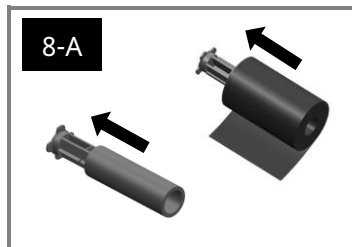
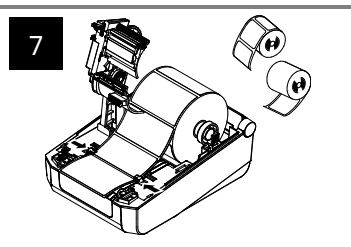
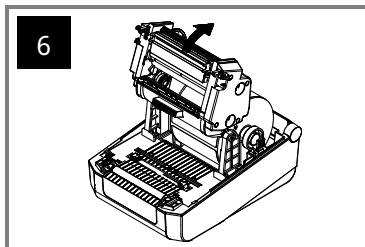
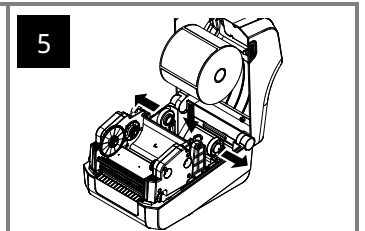
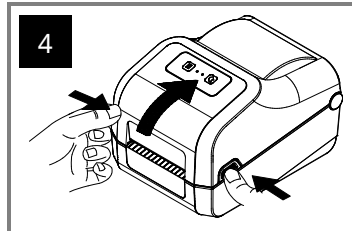
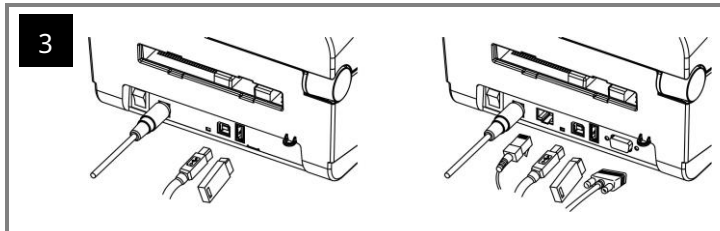
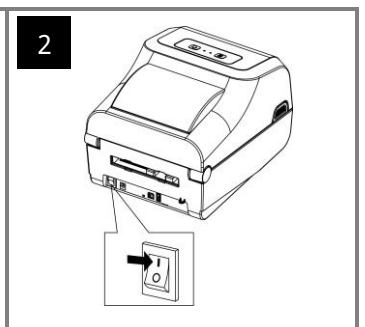
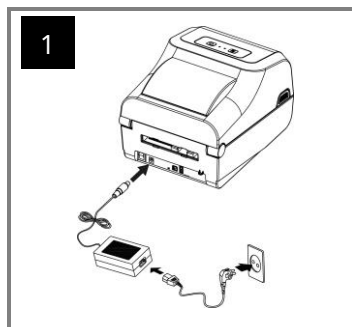
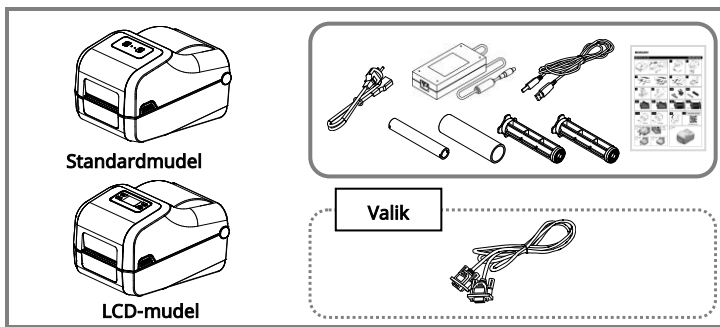

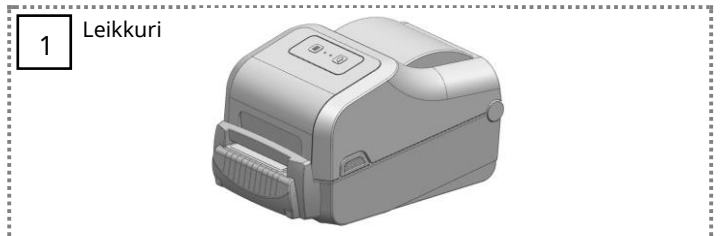
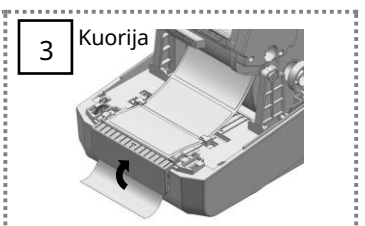
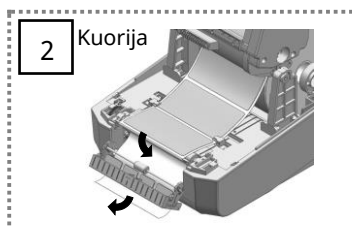
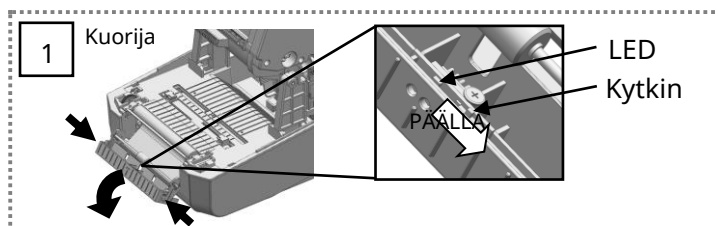
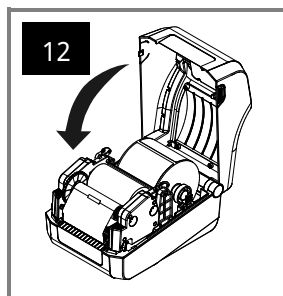
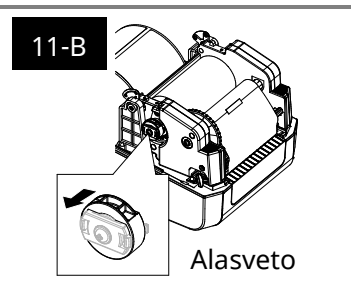
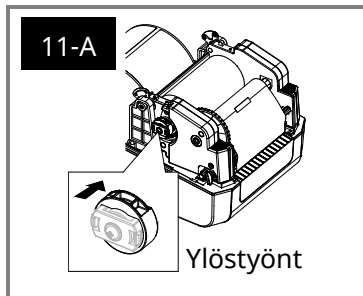
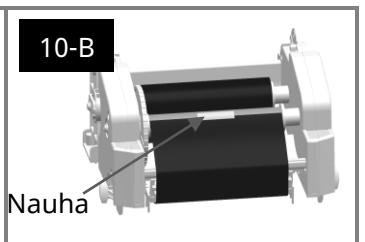
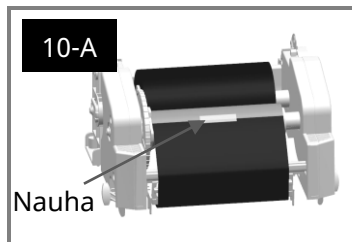
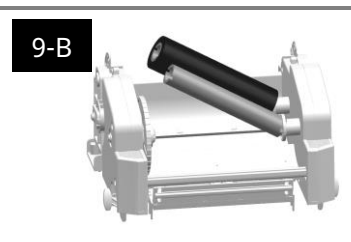
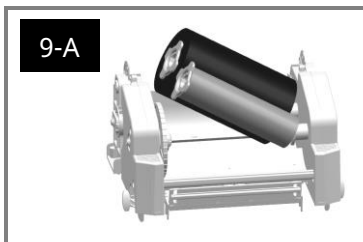
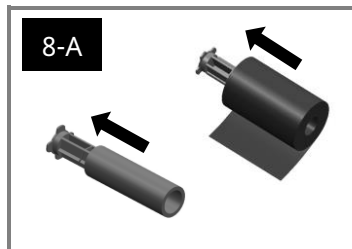
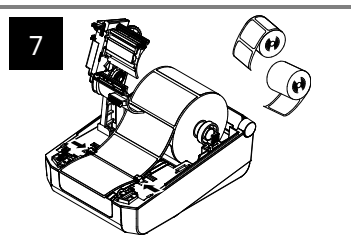
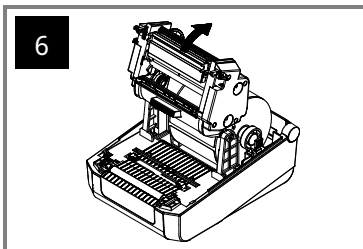
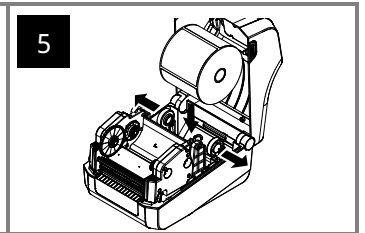
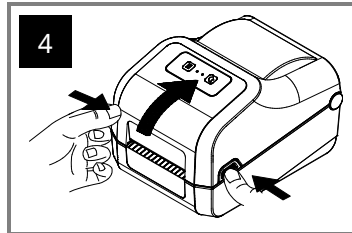
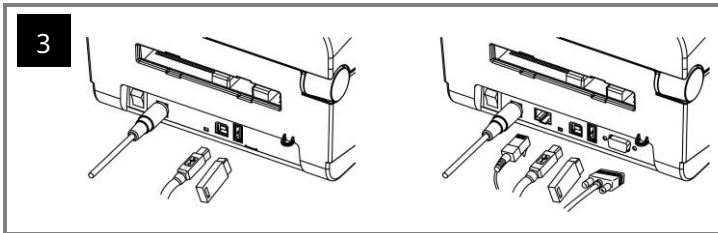
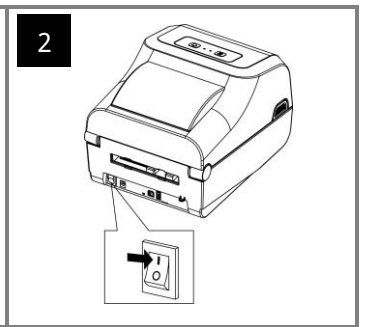
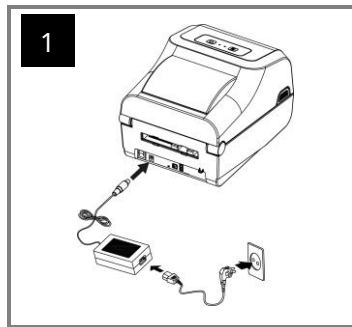
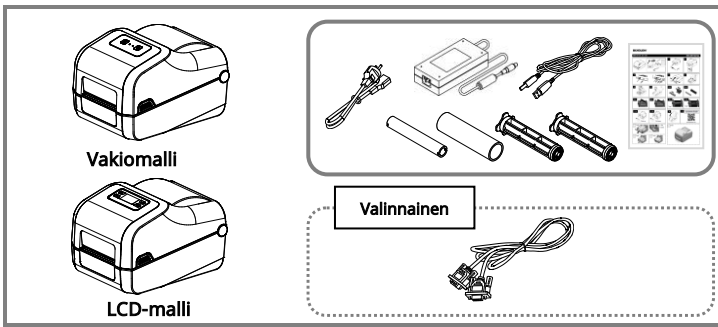



HOIATUS JA ETTEVAATUST

Seda kirjeldatakse kui surma, kehavigastusi, tõsiseid rahalisi kaotusi, andmete kahjustamist jne, mida kasutaja võib põhjustada.

Ärge ühendage mitut toodet ühe või vigase pistikupesaga. Kasutage ainult tööstusstandarditele vastavaid maandatud pistikupesasid. **Mittevastavus võib põhjustada elektrilöögi või tulekahju.**



Kasutage ainult autentseid BIXOLONi tooteid. **Ettevõtte ei paku müügilärgset tuge kahjustatud ega muude kvaliteedi/probleemide korral, mis võivad tekkida võltsitud (või taastatud) toodetel.**



Ärge painutage ega pingutage toitejuhet liigselt. Lükake toitejuhe kindlalt lõpuni pistikupesasse, et see lahti ei jääks. Hoidke juhet kindlalt kinni, kui eemaldate selle vooluvõrgust. Ärge eemaldage toitejuhet toote kasutamise ajal. **Mittevastavus võib põhjustada elektrilöögi või tulekahju.**



Hoidke väikesed tarvikud või muud pakkematerjalid väikelastest eemal. Ettevaatust: lämbumisoht. **Toote vale käsitlemine võib põhjustada vigastusi, mis võivad vajada kiiret arstiabi.**



Hoidke liigsed vedelikud toitejuhtmest ja pistikupesast eemal. Kui toitejuhtmehel on määratud ainet, pühkige seda kuiva lapiga. **Mittevastavus võib põhjustada elektrilöögi või tulekahju.**



Ärge laske rasketel esemetel toodet kahjustada. **Mittevastavus võib põhjustada elektrilöögi või tulekahju.**



Kui toode eraldab kummalist heli, põlemislõhna või suitsu, lülitage kohe toide välja ja eemaldage toitejuhe. Kui toode kukub maha või selle välispind on kahjustatud, lülitage kohe toide välja ja eemaldage toitejuhe. Ärge laske tootel pöruda. **See võib kahjustada toodet või põhjustada tulekahju.**



Paigaldage toode hästi ventileeritavasse kohta, hoides seda kindlal kaugusel seinast. Toote paigaldamine teatud keskkonnades, mis on alati liigselt tolmule, niiskusele ja temperatuurikumumistele, või toote aärmuslik kasutamine võivad printeerit kahjustada. Sisemise temperatuuri tõus võib põhjustada tulekahju. **Võtke kindlasti ostukohaga ühendust. Kui te pole toote paigutuses kindel.**



Paigaldage toode kindlasse kohta, et vältida selle ümberminekut. Toote teisaldamisel lülitage toide välja ja lahutage kõik ühendatud kaablid, sealhulgas toitejuhe. **Kuna see võib toodet kahjustada.**



Ärge kunagi võtke toodet iseseisvalt lahti, parandage ega muutke seda, kuna garantii kaotab kehtivuse. **Kui remont on vajalik, võtke ühendust algse ostukohaga.**



Ärge laske võõrkehadel tootesse sattuda. Ärge asetage tootele raskeid esemeid, vedelikke ega metalle. **See võib kahjustada toodet või põhjustada tulekahju.**



Kui tootega on probleeme, võtke ühendust algse ostukohaga või BIXOLONi veebisaidi toote remondilehe kaudu (www.bixolon.com).



VAROITUS JA HUOMIO

Kuuaa kuolemaa, fyysisiä vammaja, vakavia taloudellisia menetyksiä, tietovahinkoja jne. joita käyttäjälle voi aiheutua.

Älä liitä useita tuotteita samaan tai vialliseen pistorasiaan. Käytä vain alan standardin mukaisia maadoitettuja pistorasioita. **Määräysten noudattamatta jättäminen voi aiheuttaa sähköiskun tai tulipalon.**



Käytä vain aitoja BIXOLON-tuotteita. **Yritys ei tarjoa myynnin jälkeistä tukea vahingoissa tai muissa laatuongelmissa, joita väärennetyille (tai kunnostetuille) tuotteille voi aiheutua.**



Älä taivuta tai kiristä virtajohtoa liikaa. Työnä virtajohto turvallisesti kokonaan pistorasiasta, jotta se ei jää löysäksi. Varmista, että pidät tiukasti kiinni johdosta, kun irrotat sen pistorasiasta. **Älä irrota virtajohtoa, kun tuote on käytössä. Määräysten noudattamatta jättäminen voi aiheuttaa sähköiskun tai tulipalon.**



Pidä pienet tarvikkeet tai muu pakkausmateriaali poissa pienten lasten ulottuvilta. Varo: tukehtumisvaara. **Tuotteen virheellinen käsittely voi aiheuttaa vammoja, jotka saattavat vaatia kirurgista lääkärin hoitoa.**



Pidä ylimääräiset nesteet kaukana virtajohdosta ja pistorasiasta. Jos virtajohtoihin on tahrinutunutta ainetta, pyyhi se pois kuivalla liinalla. **Määräysten noudattamatta jättäminen voi aiheuttaa sähköiskun tai tulipalon.**



Älä anna painavien esineiden vahingoittaa tuotetta. **Määräysten noudattamatta jättäminen voi aiheuttaa sähköiskun tai tulipalon.**



Jos tuotteesta kuuluu outoa ääntä, palavaa hajua tai savua, katkaise virta välittömästi ja irrota virtajohto. Jos tuote putoaa tai sen ulkopinta vaurioituu, katkaise virta välittömästi ja irrota virtajohto. **Älä altista tuotetta iskuille. Tämä voi aiheuttaa vahinkoa tuotteelle tai tulipalon.**



Asenna tuote hyvin tuuletettuun tilaan ja pidä se tietyllä etäisyydellä seinästä. Tuotteen asentaminen tiettyihin ympäristöihin, jotka ovat alttina liialliselle pölylle, kosteudelle ja lämpötilavaihtelulle, tai tuotteen asettaminen äärimmäiseen käyttöön voi vahingoittaa tulostinta. Sisäisen lämpötilan nousu voi aiheuttaa tulipalon. **Musta ottaa yhteyttä ostopaikkaan, jos olet epävarma tuotteen sijoittamisesta.**



Asenna tuote kiinteään paikkaan, jotta se ei pääse kaatumaan. Kun siirrät tuotetta, katkaise virta ja irrota kaikki liitetyt kaapelit, myös virtajohto. **Koska se voi vahingoittaa tuotetta.**



Älä koskaan pura, korjaa tai muuta tuotetta itsenäisesti, sillä takuu raukeaa. **Jos korjaus on tarpeen, ota yhteyttä alkuperäiseen ostopaikkaan.**



Älä päästä tuotteeseen mitään vieraita aineita. **Älä aseta tuotteen päälle raskaita esineitä, nesteitä tai metalleja. Tämä voi aiheuttaa vahinkoa tuotteelle tai tulipalon.**



Jos tuotteessa on ongelma, ota yhteyttä alkuperäiseen ostopaikkaan tai BIXOLONin verkkosivuston tuotekorjaussivun kautta (www.bixolon.com).



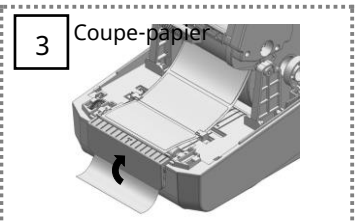
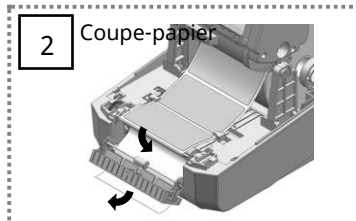
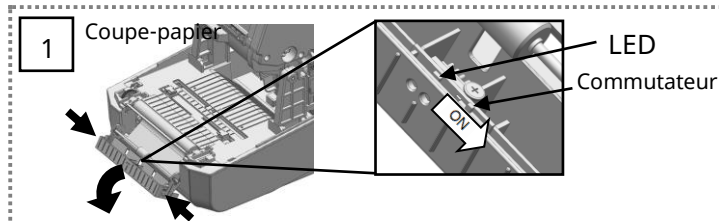
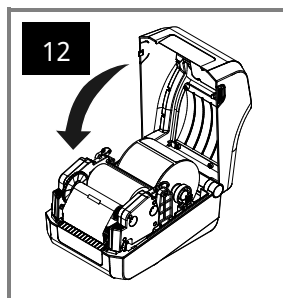
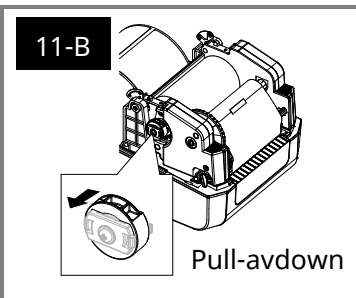
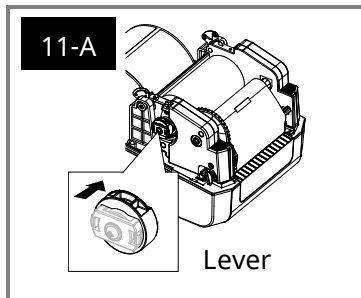
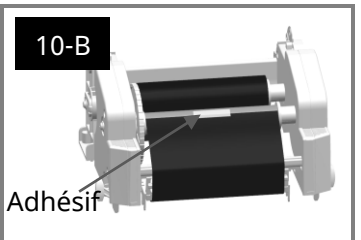
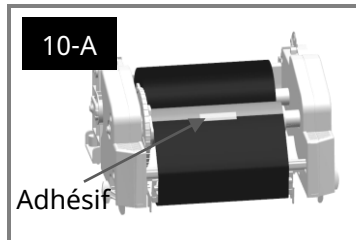
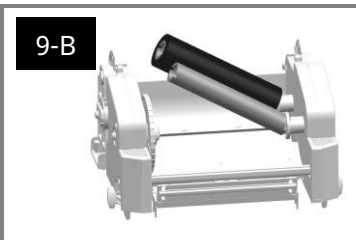
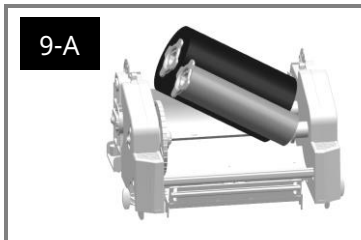
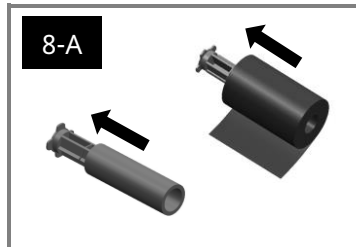
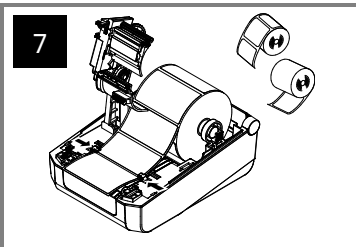
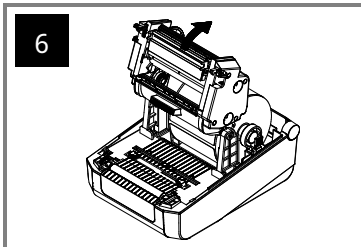
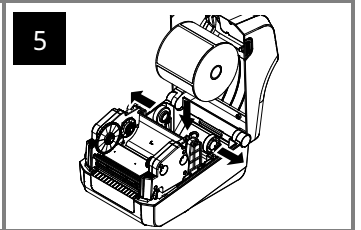
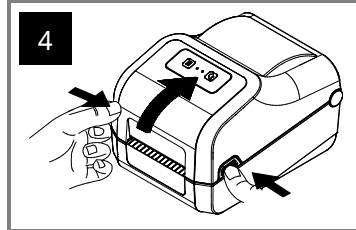
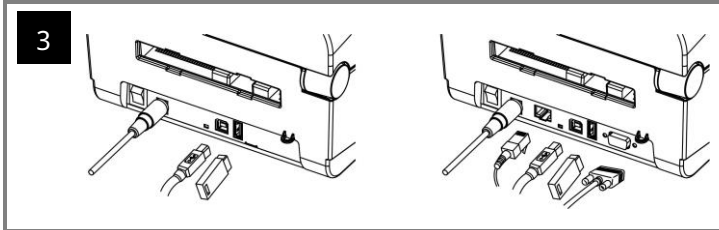
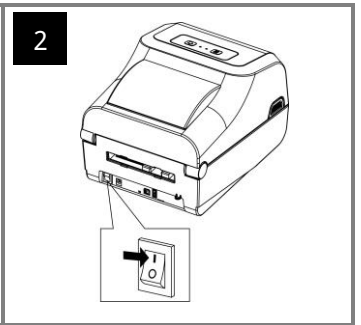
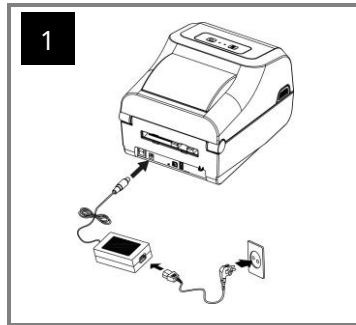
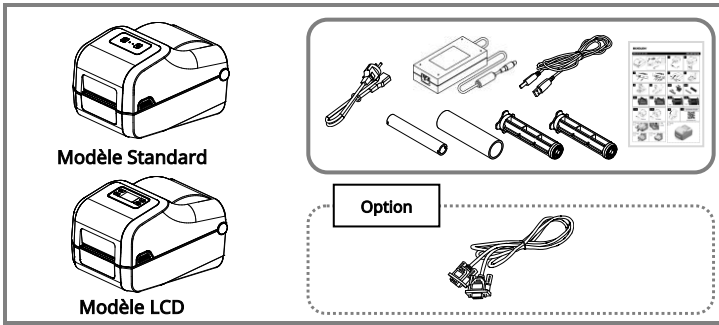

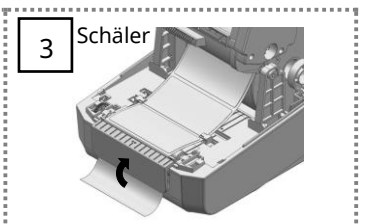
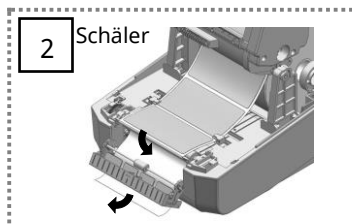
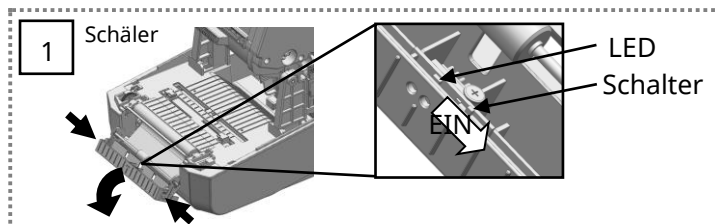
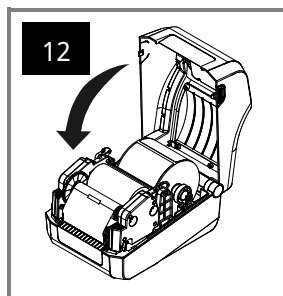
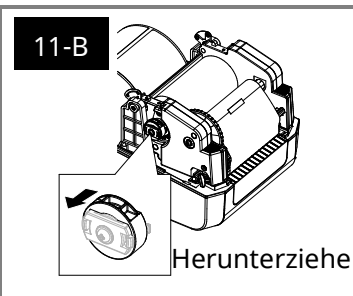
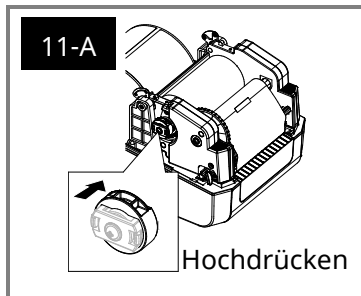
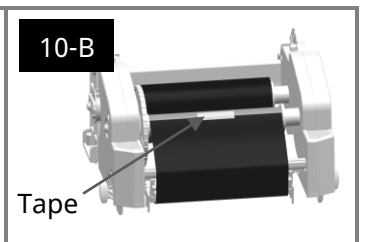
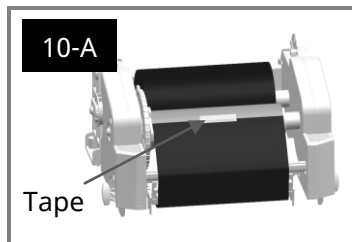
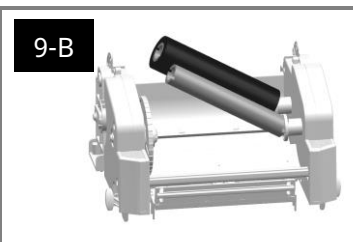
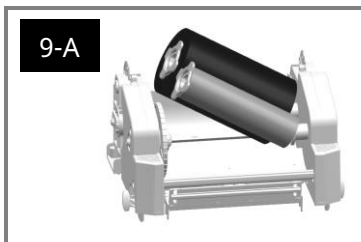
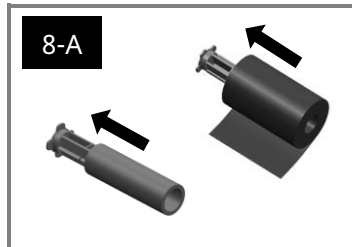
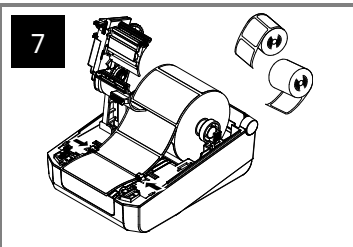
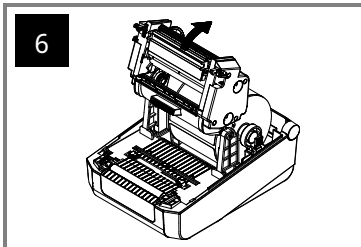
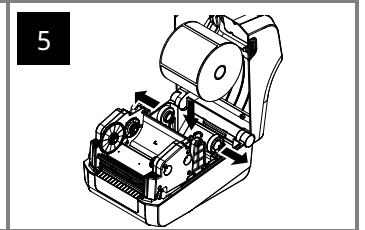
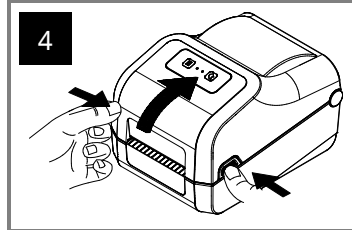
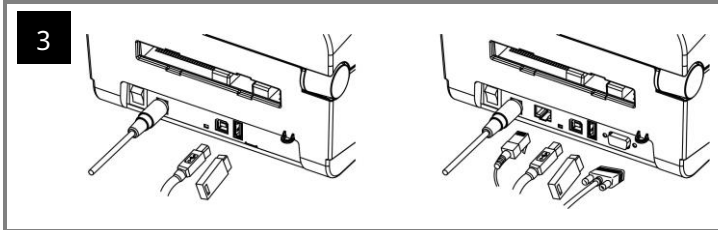
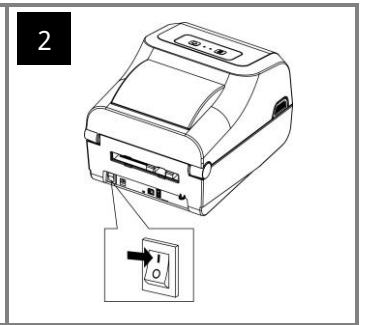
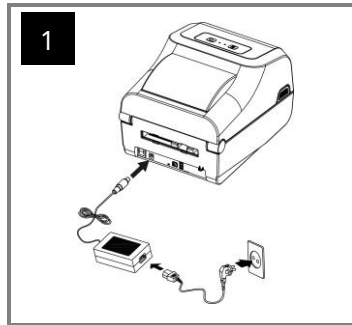
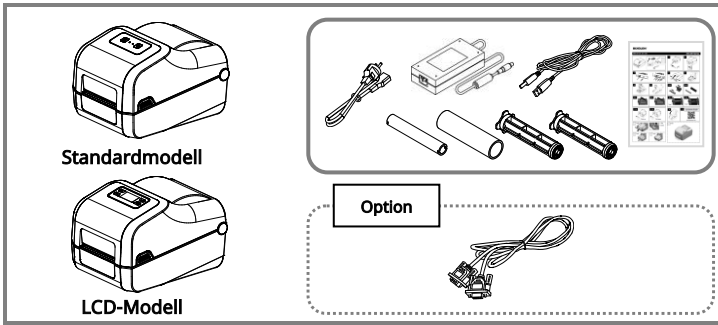



AVERTISSEMENT ET MISE EN GARDE

Cela indique qu'il existe un risque de mort, de blessures corporelles, de pertes financières graves, de dommages aux données, etc. pour l'utilisateur.

Ne branchez pas plusieurs appareils sur une même prise de courant ou sur une prise défectueuse. N'utilisez que des prises de courant avec mise à la terre conformes aux normes industrielles. **Le non-respect de cette consigne peut causer un choc électrique ou un incendie.**



Ne pliez pas ou ne tendez pas de manière excessive le cordon d'alimentation. Enfoncez fermement le cordon d'alimentation fond dans la prise de courant pour éviter qu'il ne se détache. Veillez à bien tenir le cordon lorsque vous le débranchez de la prise de courant. Ne retirez pas le cordon d'alimentation lorsque le produit est en cours d'utilisation. **Le non-respect de cette consigne peut causer un choc électrique ou un incendie.**



Tenez les liquides à l'écart du cordon d'alimentation et de la prise de courant. Si vous devez nettoyer le cordon d'alimentation, utilisez un chiffon sec. **Le non-respect de cette consigne peut causer un choc électrique ou un incendie.**

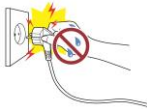

Si le produit émet un son étrange, une odeur de brûlé ou de la fumée, éteignez-le immédiatement et débranchez le cordon d'alimentation. Si le produit tombe ou s'il présente des signes de dommages, éteignez-le immédiatement et débranchez le cordon d'alimentation. **Ne soumettez pas le produit à des chocs. Le non-respect de cette consigne peut causer un choc électrique ou un incendie.**



Installez le produit dans un endroit fixe pour éviter qu'il ne bascule. Lorsque vous déplacez le produit, mettez-le hors tension et débranchez tous les câbles. Connectés. **Le non-respect de cette consigne peut endommager le produit.**



Ne laissez pas de substances étrangères pénétrer dans le produit. Ne placez pas d'objets lourds, de liquides ou de métaux sur le produit. **Le non-respect de cette consigne peut causer un choc électrique ou un incendie.**



Utilisez uniquement des produits d'origine BIXOLON. **L'entreprise ne fournira pas de service après-vente pour les dommages ou autres problèmes de qualité causés par l'utilisation de produits contrefaits (remis à neuf).**



Gardez les petits accessoires ou autres matériaux d'emballage hors de portée des jeunes enfants. Attention : risque d'étouffement. **Une mauvaise manipulation du produit peut entraîner des blessures, qui nécessiteraient l'intervention urgente d'un médecin.**



Veillez à ce que le produit ne soit pas endommagé par des objets lourds. **Le non-respect de cette consigne peut causer un choc électrique ou un incendie.**



Installez le produit dans un endroit bien ventilé en le maintenant à une certaine distance du mur. L'installation du produit dans certains environnements sujets à la poussière, à l'humidité et aux variations de température excessives ou l'utilisation extrême du produit peuvent endommager l'imprimante. Une augmentation de la température interne peut provoquer un incendie. **Veillez à contacter le lieu d'achat si vous n'êtes pas sûr de l'emplacement du produit.**

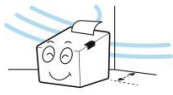

Ne tentez jamais de démonter, réparer ou modifier le produit vous-même, sous peine d'annuler la garantie. **Si une réparation est nécessaire, contactez votre revendeur.**



En cas de problème avec le produit, veuillez contacter le lieu d'achat d'origine ou la page de réparation des produits du site web de BIXOLON (www.bixolon.com).



WARNUNG & VORSICHTSMAßNAHMEN

Durch Nichtbeachtung der nachstehenden Hinweise kann es zu Datenschutzschäden, Vermögensschäden, schweren Personenverletzungen oder tödlichen Unfällen kommen.

Schließen Sie nicht mehrere Produkte an eine einzige fehlerhafte Steckdose an. Verwenden Sie nur geerdete Steckdosen, die den Industriestandards entsprechen. **Eine Nichtbeachtung kann zu einem elektrischen Schlag oder zu einem Brand führen.**



Biegen oder belasten Sie das Netzkabel nicht übermäßig. Stecken Sie das Netzkabel fest in die Steckdose, damit es nicht lose ist. Achten Sie darauf, das Kabel festzuhalten, wenn Sie es von der Steckdose nehmen. Entfernen Sie das Netzkabel nicht, während das Produkt verwendet wird. **Eine Nichtbeachtung kann zu einem elektrischen Schlag oder zu einem Brand führen.**



Halten Sie übermäßige Flüssigkeiten vom Netzkabel und der Steckdose fern. Wenn die Netzkabel verschmiert sind, wischen Sie sie mit einem trockenen Tuch ab. **Eine Nichtbeachtung kann zu einem elektrischen Schlag oder zu einem Brand führen.**



Wenn das Produkt ein seltsames Geräusch, Brandgeruch oder Rauch abgibt, schalten Sie es sofort aus und ziehen Sie das Netzkabel ab. Wenn das Produkt fallen gelassen oder äußerlich beschädigt wird, schalten Sie es sofort aus und ziehen Sie das Netzkabel ab. Setzen Sie das Produkt keinen Stößen aus. **Dies könnte zu Schäden am Gerät oder zu einem Brand führen.**



Installieren Sie das Produkt an einem festen Ort, um ein Umkippen zu verhindern. Wenn Sie das Produkt bewegen wollen, schalten Sie es aus und trennen Sie alle angeschlossenen Kabel, einschließlich des Netzkabels. **Andernfalls kann dies das Produkt beschädigen.**



Lassen Sie keine Fremdstoffe in das Produkt eindringen. Stellen Sie keine schweren Gegenstände, Flüssigkeiten oder Metalle auf das Produkt. **Dies könnte zu Schäden am Produkt oder einem Brand führen.**



Verwenden Sie nur authentische Produkte von BIXOLON. **Das Unternehmen bietet keinen Support für beschädigte oder sonstige Qualitätsprobleme, die bei gefälschten (oder generalüberholten) Produkten nach dem Kauf auftreten können.**



Halten Sie kleine Zubehöerteile oder andere Verpackungsmaterialien von kleinen Kindern fern. Achtung: Erstickungsgefahr. **Eine unsachgemäße Handhabung des Produkts kann zu Verletzungen führen, die möglicherweise dringende medizinische Maßnahmen erfordern.**



Lassen Sie das Produkt nicht durch schwere Gegenstände beschädigen. **Eine Nichtbeachtung kann zu einem elektrischen Schlag oder zu einem Brand führen.**



Installieren Sie das Produkt in einem gut belüfteten Bereich und halten Sie einen gewissen Abstand zur Wand. Wenn Sie das Produkt bestimmten Umgebungsbedingungen, wie übermäßigem Staub, Feuchtigkeit, oder Temperaturschwankungen aussetzen, oder es extrem beanspruchen, kann es beschädigt werden. **Eine Zunahme der internen Temperatur kann einen Brand auslösen. Wenden Sie sich an Ihren Händler, wenn Sie sich bezüglich der Produktpositionierung nicht sicher sind.**



Zerlegen, reparieren oder modifizieren Sie das Produkt niemals selbstständig, da andernfalls die Garantie erlischt. **Wenn eine Reparatur erforderlich ist, wenden Sie sich an die ursprüngliche Verkaufsstelle.**



Wenn es ein Problem mit dem Produkt gibt, wenden Sie sich bitte an die ursprüngliche Verkaufsstelle oder über die Produktreparaturseite der BIXOLON-Website (www.bixolon.com).



XD5-40II Series

Βασικό μοντέλο

Μοντέλο

Επιλογή

1

2

3

4

5

6

7

8-A

8-B

9-A

9-B

10-A

Ταινία

10-B

Ταινία

11-A

Ωθηση προς τα πάνω

11-B

Ωθηση προς τα κάτω

12

13

Για λήψη περισσότερων πληροφοριών, επισκεφτείτε τον ιστότοπο της BIXOLON.

1 Εργαλείο

Λυχνία Διακόπτης

ΕΝΕΡΓΟ

2 Εργαλείο

3 Εργαλείο

4 Εργαλείο

1 Κοπίδι

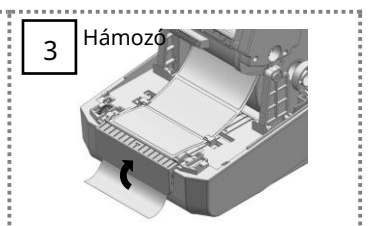
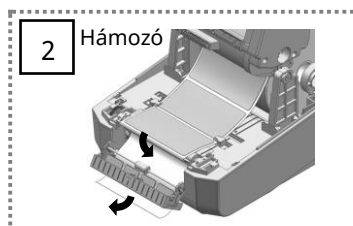
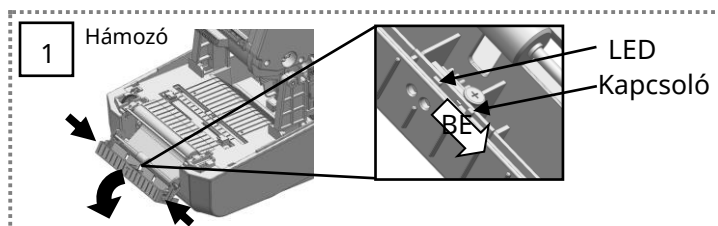
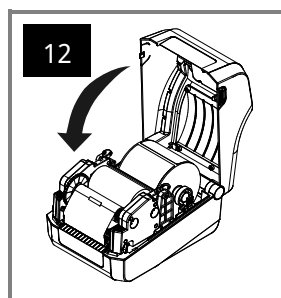
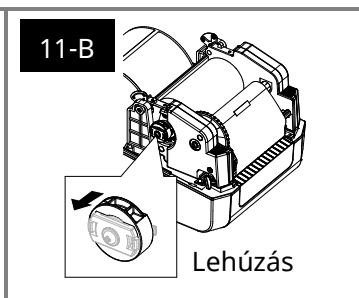
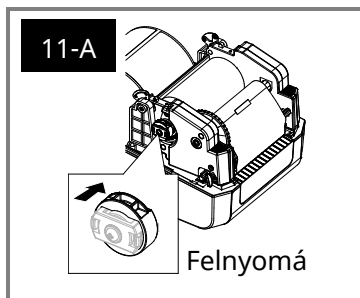
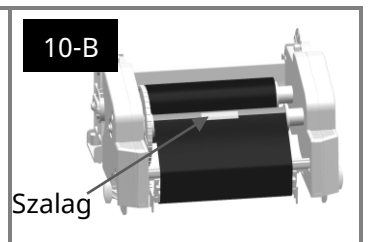
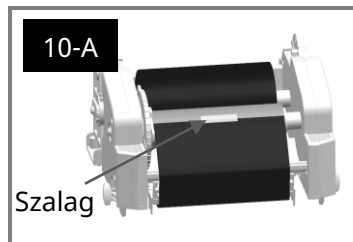
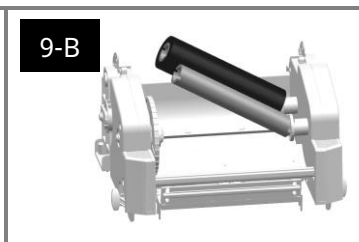
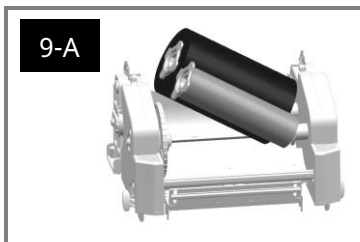
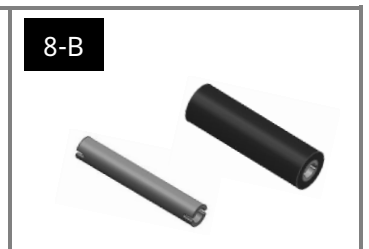
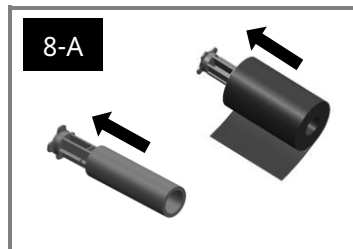
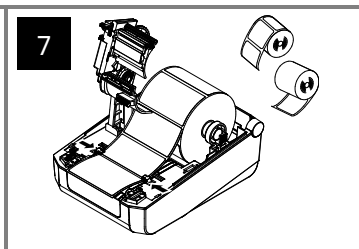
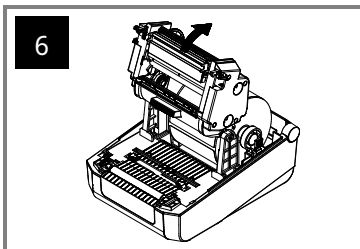
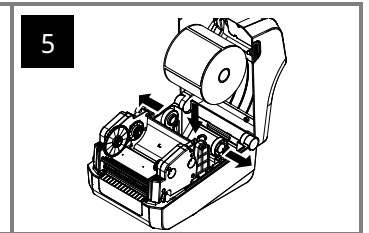
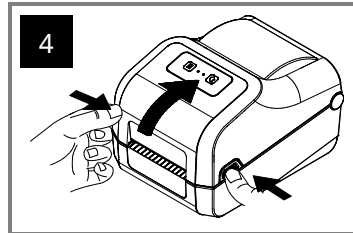
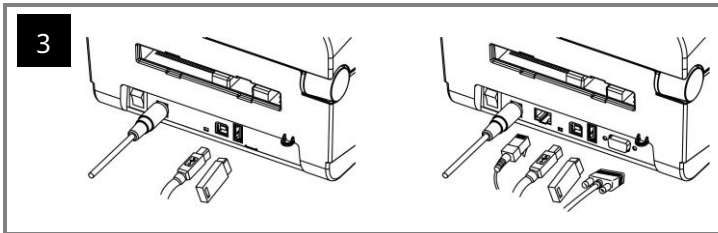
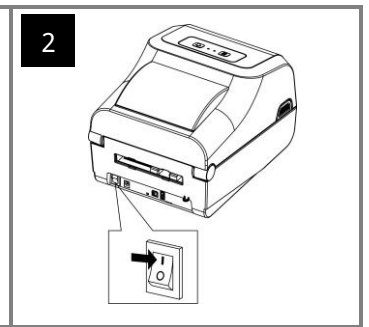
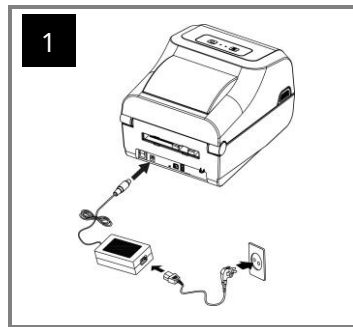
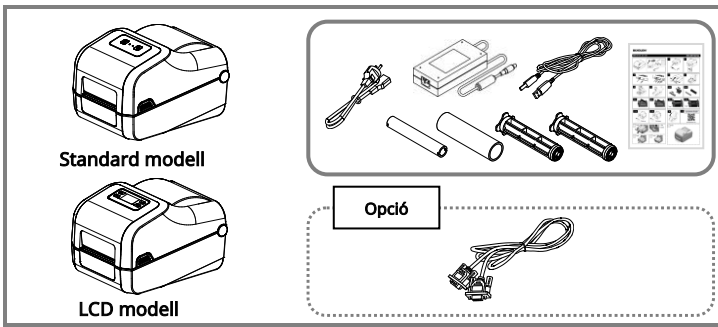



ΠΡΟΕΙΔΟΠΟΙΗΣΗ ΚΑΙ ΠΡΟΣΟΧΗ

Περιγράφεται ως θάνατος, σωματικοί τραυματισμοί, σοβαρές οικονομικές απώλειες και ζημιές σε δεδομένα κ.λπ. που μπορεί να προκληθούν στον χρήστη.

Μη συνδέετε πολλά προϊόντα σε μία μόνο πρίζα ή σε μια ελαττωματική πρίζα. Χρησιμοποιείτε μόνο γεωμενές πρίζες οι οποίες πληρούν τα βιομηχανικά πρότυπα. **Η μη συμμόρφωση μπορεί να προκαλέσει ηλεκτροπληξία ή πυρκαγιά.**



Χρησιμοποιείτε μόνο αυθεντικά προϊόντα της BIXOLON. **Η πωλητήρια δεν θα παρέχει υποστήριξη μετά την πώληση για προϊόντα τα οποία έχουν καταστραφεί ή άλλα ζητήματα ποιότητας που ενδέχεται να προκύψουν από πλαστά (ή ανακατασκευασμένα) προϊόντα.**



Μη λυγίζετε ή καταπονείτε υπερβολικά το καλώδιο ρεύματος. Πηγάτε με ασφάλεια το καλώδιο ρεύματος μέχρι τέρας στην πρίζα, καθώς δεν πρέπει να είναι χαλαρό. Βεβαιωθείτε ότι κρατάτε καλά το καλώδιο όταν το αφαιρείτε από την πρίζα. **Μην αφαιρείτε το καλώδιο ρεύματος ενόσω το προϊόν βρίσκεται σε χρήση. Η μη συμμόρφωση μπορεί να προκαλέσει ηλεκτροπληξία ή πυρκαγιά.**



Διατηρείτε τα μικρά αξεσουάρ ή άλλα υλικά συσκευασίας μακριά από μικρά παιδιά. Προσοχή: **Ο λανθασμένος χειρισμός του προϊόντος μπορεί να προκαλέσει τραυματισμούς οι οποίοι ενδέχεται να απαιτήσουν επείγουσα ιατρική βοήθεια.**



Κρατήστε μεγάλες ποσότητες υγρών μακριά από το καλώδιο ρεύματος και την πρίζα. Σε περίπτωση που επαλειφθεί κάποια ουσία στα καλώδια ρεύματος, σκουπίστε με ένα στεγνό πανί. **Η μη συμμόρφωση μπορεί να προκαλέσει ηλεκτροπληξία ή πυρκαγιά.**

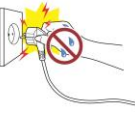

Μην επιτρέψετε καταστροφή του προϊόντος από βαριά αντικείμενα. **Η μη συμμόρφωση μπορεί να προκαλέσει ηλεκτροπληξία ή πυρκαγιά.**



Εάν το προϊόν εκπέμπει περίεργο ήχο, μυρωδιά καμένου ή καπνό, απενεργοποιήστε αμέσως το ρεύμα και αποσυνδέστε το καλώδιο ρεύματος. Σε περίπτωση πτώσης του προϊόντος ή φθοράς του εξωτερικού περιβλήματος, απενεργοποιήστε αμέσως το ρεύμα και αποσυνδέστε το καλώδιο ρεύματος. **Μην υπερβείτε το προϊόν σε κραδασμούς. Κάτι τέτοιο μπορεί να προκαλέσει ζημιά στο προϊόν ή πυρκαγιά.**



Εγκαταστήστε το προϊόν σε καλά αεριζόμενο χώρο διατήρησής του σε συγκεκριμένη απόσταση από τον τοίχο. Η εγκατάστασή του προϊόντος σε συγκεκριμένα περιβάλλοντα τα οποία είναι επιρρεπή σε υπερβολική σκόνη, υγρασία και διακυμάνσεις θερμοκρασίας ή η τοποθέτησή του προϊόντος σε ακραία χρήση μπορεί να προκαλέσει βλάβη στον εκτυπωτή. Μια αύξηση στην εσωτερική θερμοκρασία μπορεί να προκαλέσει πυρκαγιά. **Μην παραλείψετε να επικοινωνήσετε με το κατάστημα από το οποίο αγοράσατε το προϊόν εάν δεν είστε σίγουροι για την τοποθέτησή του.**



Εγκαταστήστε το προϊόν σε σταθερή θέση προς αποτροπή ενδεχόμενης ανατροπής του. Όταν μετακινείτε το προϊόν, απενεργοποιήστε το ρεύμα και αποσυνδέστε όλα τα συνδεδεμένα καλώδια, συμπεριλαμβανομένου του καλωδίου ρεύματος. **Κάτι τέτοιο μπορεί να βλάψει το προϊόν.**



Μην αποσυρμαριολογείτε, επισκευάζετε ή τροποποιείτε ποτέ από μόνοι σας το προϊόν, καθώς η εγγύηση θα καταστεί άκυρη. **Όταν απαιτείται επισκευή, επικοινωνήστε με το κατάστημα στο οποίο πραγματοποιήσατε την αγορά.**



Μην αφήνετε να εισέρχονται ξένες ουσίες στο προϊόν. Μην τοποθετείτε βαριά αντικείμενα, υγρά ή μέταλλα πάνω στο προϊόν. **Κάτι τέτοιο μπορεί να προκαλέσει ζημιά στο προϊόν ή πυρκαγιά.**



Εάν υπάρχει πρόβλημα με το προϊόν, επικοινωνήστε με το κατάστημα από το οποίο αγοράσατε το προϊόν ή με τη σελίδα επισκευής προϊόντων του ταξινότου BIXOLON (www.bixolon.com).



FIGYELMEZTETÉS ÉS VIGYÁZAT

A felhasználónak okozott halál, testi sérülés, súlyos pénzügyi veszteség, adatkárosodás stb.

Ne csatlakoztasson több terméket egyetlen vagy hibás konnektorhoz. Csak az ipari szabványnak megfelelő konnektort használjon. **A nem megfelelő elektromos csatlakozóaljzat áramütést vagy tüzet okozhat.**



Csak a BIXOLON hiteles termékeit használja. **A vállalat nem nyújt eladás utáni támogatást hamisított (vagy felújított) termékek esetén felmerülő terméksérülés vagy egyéb minőségi problémák miatt.**



Ne hajlítsa meg vagy ne feszítse meg túlzottan a tápkábelt. Biztonságosan nyomja be teljesen a tápkábelt a konnektorba, nehogy meglazuljon. Ügyeljen arra, hogy szorosan tartsa a kábelt, amikor kihúzza a konnektorból. Ne húzza ki a tápkábelt, amíg a termék használatban van. **A nem megfelelő elektromos csatlakozóaljzat áramütést vagy tüzet okozhat.**



A kis tartozékokat vagy egyéb csomagolóanyagokat tartsa távol a kisgyermekektől. Vigyázat: fulladásveszély. **A termék helytelen kezelése olyan sérüléseket okozhat, amelyek sürgős orvosi ellátást igényelhetnek.**



Tartsa távol a túlzott mennyiségű folyadékot a tápkábeltől és a konnektortól. Ha anyag került a tápkábelekre, törölje le száraz ruhával. **A nem megfelelő elektromos csatlakozóaljzat áramütést vagy tüzet okozhat.**



Ne hagyja, hogy a terméket nehéz tárgyak károsítsák. **A nem megfelelő elektromos csatlakozóaljzat áramütést vagy tüzet okozhat.**



Ha a termék furcsa hangot bocsát ki, égszszaga van vagy füstöl, azonnal kapcsolja ki a készüléket, és húzza ki a tápkábelt. Ha a terméket leejtik, vagy a külseje megsérül, azonnal kapcsolja ki a készüléket, és húzza ki a tápkábelt. Ne tegye ki a terméket utesnek. **Ez a termék károsodását vagy tüzet okozhat.**



Telepítse a terméket jól szellős helyen, a kellő távolságra a faltól. A termék olyan környezetben történő telepítése, amelyben túlzott párnak, nedvességnek és hőmérséklet-ingadozásnak lehet kitéve, vagy a termék túlzott igénybevétele a nyomtató károsodását okozhatja. A belső hőmérséklet emelkedése tüzet okozhat. **Ha bizonytalan a termék elhelyezését illetően, forduljon a vásárlási helyhez.**



Rögzített helyre telepítse a terméket, hogy megakadályozza a felborulást. A termék mozgathatóságát kapcsolja ki a készüléket, és húzza ki az összes csatlakoztatott kábelt, beleértve a tápkábelt is. **Ugyanis ez károsíthatja a terméket.**



Soha ne szerelje szét, ne javítsa vagy módosítsa a terméket önállóan, mert a jótállás érvényét veszti. **Ha javításra van szükség, forduljon az eredeti vásárlási helyhez.**



Ne engedje, hogy a termékbe idegen anyag kerüljön. Ne helyezzen nehéz tárgyakat, folyadékokat vagy fémeket a termékre. **Ez a termék károsodását vagy tüzet okozhat.**









Ha a termékkel probléma merül fel, kérjük, forduljon a vásárlási helyhez vagy keresse fel a BIXOLON weboldalának termékjavítási oldalát (www.bixolon.com).

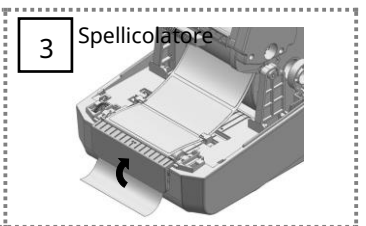
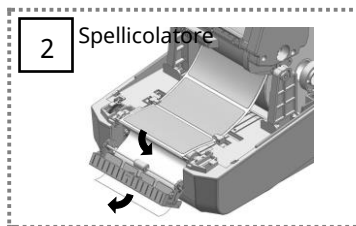
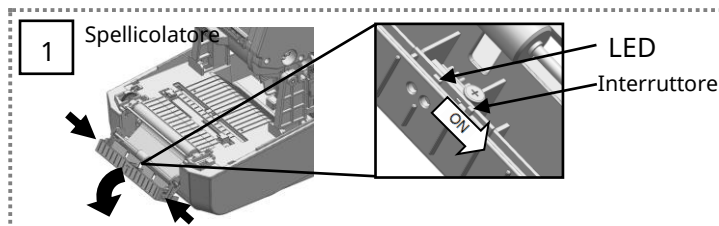
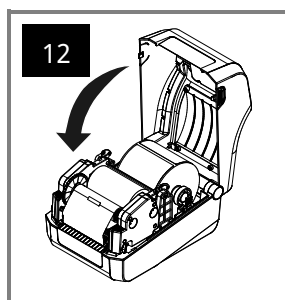
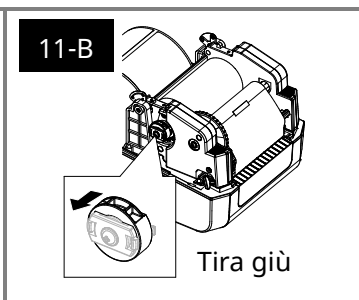
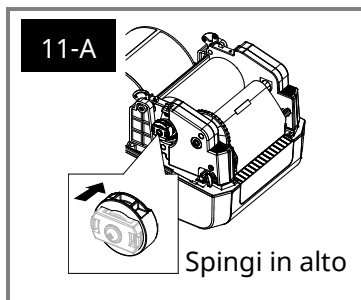
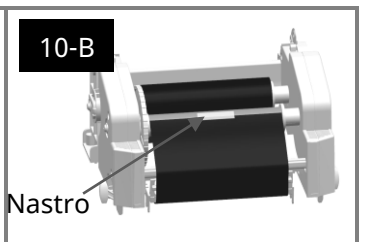
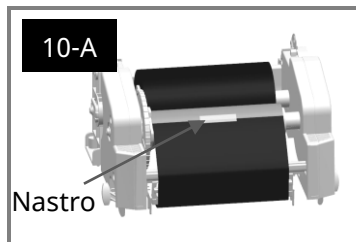
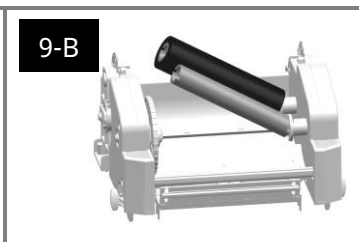
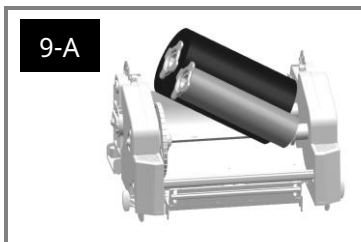
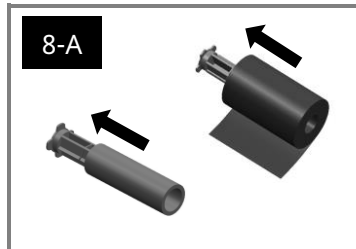
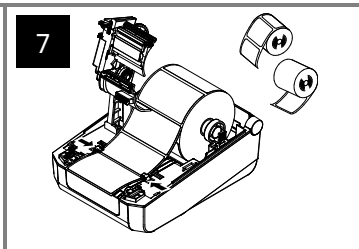
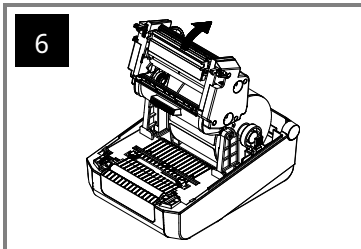
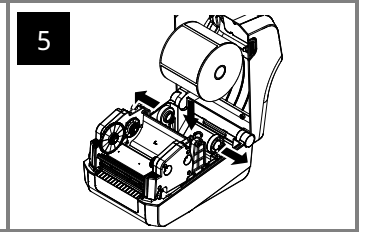
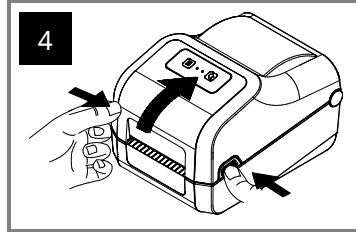
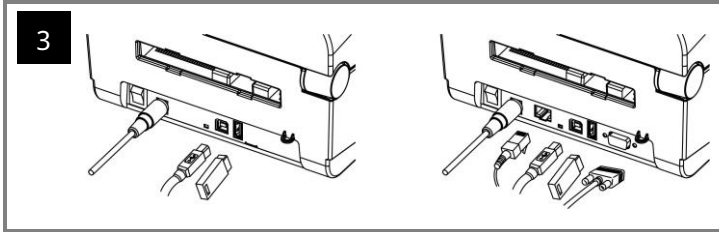
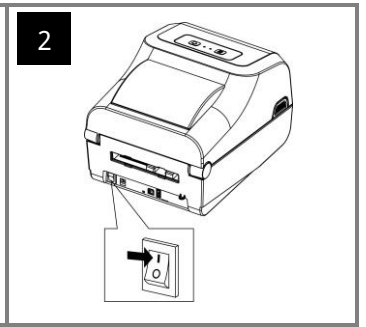
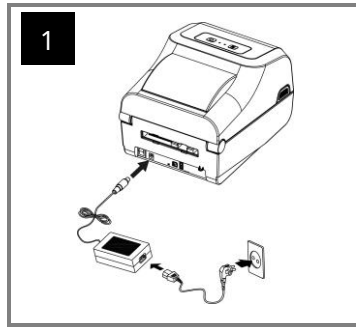
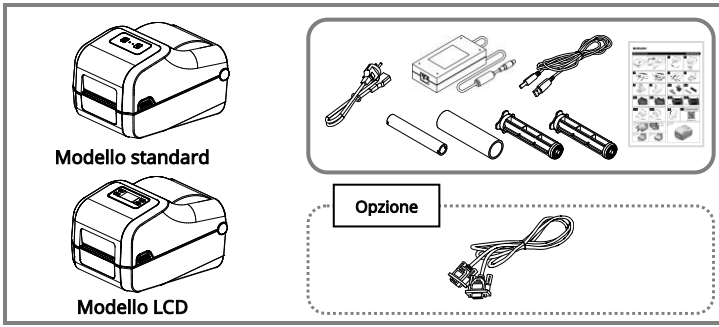

Greek

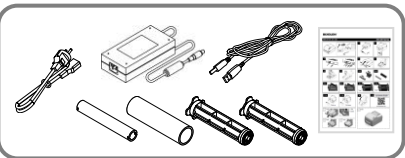
Hungarian

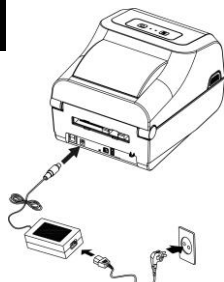

 <p>Standarta modelis</p>  <p>LCD modelis</p>	 <p>Opcija</p> 	<p>1</p> 	<p>2</p> 
---	---	---	--

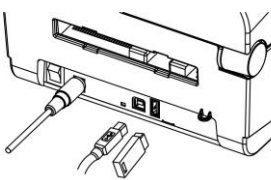
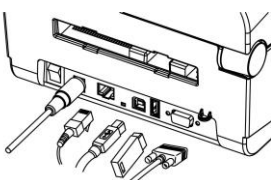
<p>3</p> 	
--	---

4

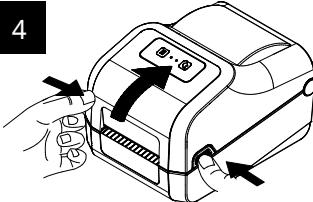

5

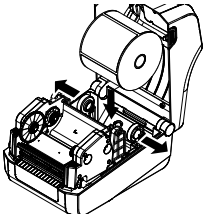

6

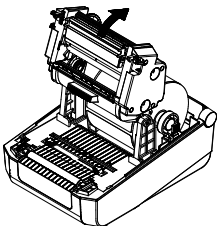

7

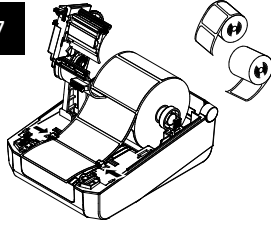

8-A

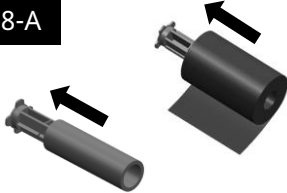

8-B



9-A

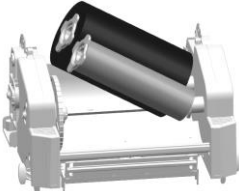

9-B

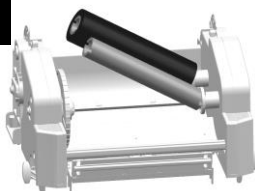

10-A

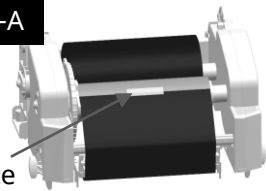

Lente

10-B

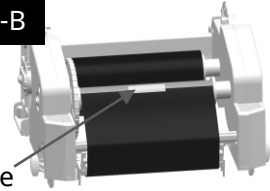

Lente

11-A

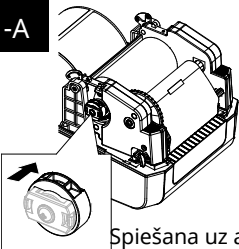

Spiešana uz augšu

11-B

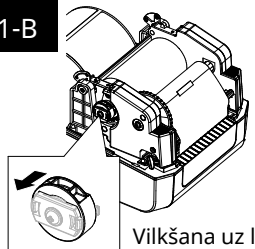

Vilkšana uz leju

12

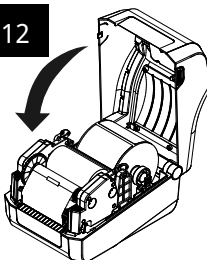

13

Lai lejupielādētu vairāk informācijas, lūdzu, apmeklējiet BIXOLON vietni.



1 Atdalītājs

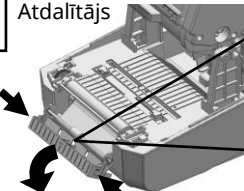

LED Slēdzis

IESLEGTIS

2 Atdalītājs

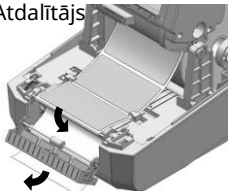

3 Atdalītājs

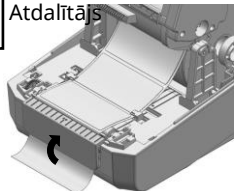

4 Atdalītājs



1 Griezējs





AVVERTENZA E CAUTELA

Si intende il rischio di morte, lesioni fisiche, gravi perdite economiche, danni ai dati, ecc. che possono essere arrecati all'utente.

Non collegare più di un dispositivo a una singola presa di corrente o a una presa difettosa. Utilizzare solo prese di corrente con messa a terra conformi agli standard industriali. **La mancata osservanza di queste regole può causare scosse elettriche o incendi.**



Non piegare o sforsare eccessivamente il cavo di alimentazione. Spingere saldamente il cavo di alimentazione fino in fondo nella presa di corrente per evitare che rimanga allentato. Assicurarsi di tenere il cavo ben saldo quando lo si stacca dalla presa di corrente. Non rimuovere il cavo di alimentazione mentre il dispositivo è in uso. **La mancata osservanza di queste regole può causare scosse elettriche o incendi.**



Utilizzare solo prodotti autentici di BIXOLON. **L'azienda non fornirà assistenza post-vendita per i danni o altri problemi di qualità che potrebbero verificarsi con i prodotti falsi (o ricondizionati).**



Tenere i piccoli accessori o altri materiali di imballaggio lontano dalla portata dei bambini. Avvertenza: pericolo di soffocamento. **L'uso improprio del dispositivo può provocare lesioni che possono richiedere l'intervento urgente di un medico.**



Tenere i liquidi in quantità eccessiva lontano dal cavo di alimentazione e dalla presa di corrente. Eventuali impurità sui cavi di alimentazione devono essere pulite con un panno asciutto. **La mancata osservanza di queste regole può causare scosse elettriche o incendi.**

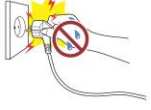

Non lasciare che il dispositivo venga danneggiato da oggetti pesanti. **La mancata osservanza di queste regole può causare scosse elettriche o incendi.**



Se il dispositivo emette suoni strani, odore di bruciato o fumo, spegnerlo immediatamente e scollegare il cavo di alimentazione. Se il dispositivo cade o viene danneggiato all'esterno, spegnerlo immediatamente e scollegare il cavo di alimentazione. **Non sottoporre il dispositivo a urti. Ciò potrebbe provocare danni al dispositivo o un incendio.**



Installare il dispositivo in un'area ben ventilata, tenendolo a una certa distanza dalla parete. L'installazione della stampante in determinati ambienti esposti a un'eccessiva presenza di polvere, umidità e fluttuazioni di temperatura o un uso particolarmente intenso della stessa può provocare danni al dispositivo. Un aumento della temperatura interna può innescare un incendio. **Se non si è sicuri della collocazione del dispositivo, contattare il negoziante in cui esso è stato acquistato.**



Installare il dispositivo in un luogo fisso per prevenire il ribaltamento. Quando si sposta il dispositivo, spegnere l'alimentazione e scollegare tutti i cavi collegati, compreso il cavo di alimentazione. **In caso contrario, si rischia di danneggiare il dispositivo.**



Non smontare, riparare o modificare il prodotto per conto proprio, poiché ciò farebbe decadere la garanzia. **Qualora si renda necessaria una riparazione, rivolgersi al rivenditore originale.**



Non far penetrare sostanze estranee nel dispositivo. Non collocare oggetti pesanti, liquidi o metalli sul dispositivo. **Ciò potrebbe provocare danni al dispositivo o un incendio.**



In caso di problemi con il dispositivo, contattare il rivenditore originale o la pagina di assistenza tecnica del sito web (www.bixolon.com).



BRĪDINĀJUMS / IEVĒROT PIESARDZĪBU

Nozīmē nāvi, traumas, nopietnus finansiālus zaudējumus, datu bojājumus u.c., kas var tikt nodarīti lietotājam.

Nepieslēdziet vairākus izstrādājumus vienai vai bojātai strāvas kontaktligzdai. Izmantojiet tikai tādas iezemētas kontaktligzdas, kas atbilst nozares standartiem. **Neievērošana var izraisīt strāvas triecienu vai ugunsgrēku.**



Izmantojiet tikai autentiskus BIXOLON izstrādājumus. **Uzņēmums nesniegs pēcpārdošanas atbalstu bojājumu vai citu kvalitātes problēmu gadījumā, kas var rasties saistībā ar viltotiem (vai atjaunotiem) izstrādājumiem.**



Pārmērīgi nelieciet un nenostiepiet strāvas vadu. Droši iebīdīet strāvas vadu līdz galam strāvas kontaktligzdā, lai tas nepaliktu valģis. Pārļiecinieties, ka, atvienojot vadu no strāvas kontaktligzdas, turat to cieši. **Neatvienojiet strāvas vadu, kamēr izstrādājums tiek lietots. Neievērošana var izraisīt strāvas triecienu vai ugunsgrēku.**



Nelielus piederumus vai citus iepakojuma materiālus glabājiet tā, lai tie nebūtu pieejami maziem bērniem. **Uzmanieties: aizīšanās risks. Nepareiza apīšanās ar izstrādājumu var radīt traumas, kuru dēļ var būt nepieciešama steidzama medicīniskā palīdība.**



Uzglabājiet lielus šķidrumu daudzumus tālu no strāvas vada un kontaktligzdas. Ja uz strāvas vadiem ir uzsmērēta kāda viela, noslaukiet to ar sausu drānu. **Neievērošana var izraisīt strāvas triecienu vai ugunsgrēku.**



Nepieļaujiet, ka izstrādājumu sabojā smagi priekšmeti. **Neievērošana var izraisīt strāvas triecienu vai ugunsgrēku.**



Ja izstrādājums rada dīvainu skāņu, deguma smaku vai dūmus, nekavējoties izslēdziet strāvas padevi un atvienojiet strāvas vadu. Ja izstrādājums ir nokritis vai tā ārpusē ir bojāta, nekavējoties izslēdziet strāvas padevi un atvienojiet strāvas vadu. **Nepieļaujiet izstrādājumu triecieniem. Tas var izraisīt izstrādājuma bojājumus vai ugunsgrēku.**



Uzstādiet izstrādājumu labi vēdināmā vietā, ievērojot noteiktu attālumu no sienas. Izstrādājuma uzstādīšana noteiktās vidēs, kurās ir tendence uz pārmērīgu putekļu, mitruma daudzumu un temperatūras svārstībām, vai izstrādājuma izmantošana ekstremālos apstākļos var izraisīt printera bojājumus. Iekšējās temperatūras paaugstināšanās var izraisīt ugunsgrēku. **Ja nesat pārliecinātā par izstrādājuma novietojumu, sazinieties ar pīrkšanas vietu.**

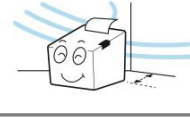

Uzstādiet izstrādājumu stabilā vietā, lai novērstu tā apgāšanos. Pārvietojot izstrādājumu, izslēdziet strāvas padevi un atvienojiet visus pievienotos vadus, tostarp strāvas vadu. **Citādi var sabojāt izstrādājumu.**



Nekad patstāvīgi neizjauciet, neremontējiet vai neveiciet izmaiņas izstrādājumā, jo tad garantija zaudēs spēku. **Ja nepieciešams remonts, sazinieties ar sākotnējo iegādes vietu.**



Nepieļaujiet, ka izstrādājumā nonāk jebkādas svešķermeņi. Nenovietojiet uz izstrādājuma smagus priekšmetus, šķidrumus vai metālus. **Tas var izraisīt izstrādājuma bojājumus vai ugunsgrēku.**



Ja rodas problēmas ar izstrādājumu, lūdz, sazinieties ar sākotnējo iegādes vietu vai izmantojiet BIXOLON tīmekļa vietnes izstrādājuma remonta lapu (www.bixolon.com).

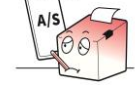

Italian

Latvian

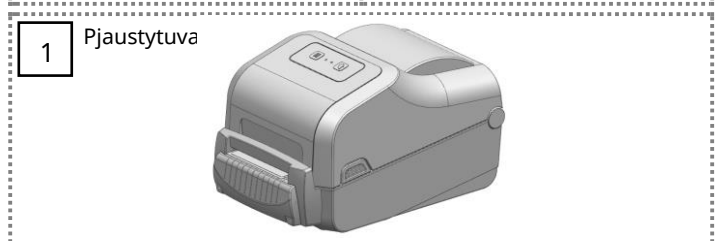
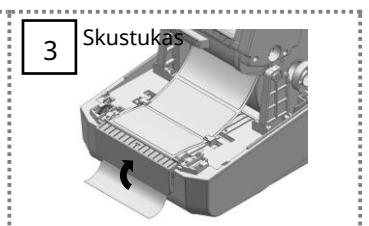
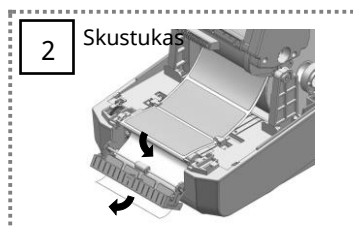
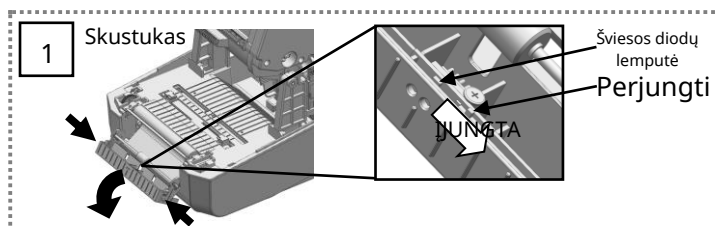
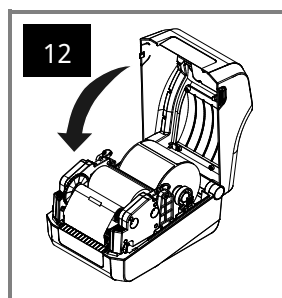
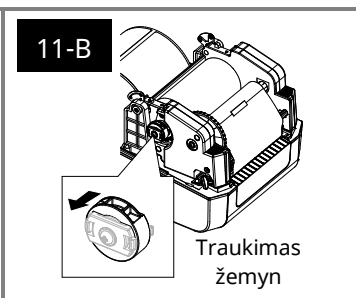
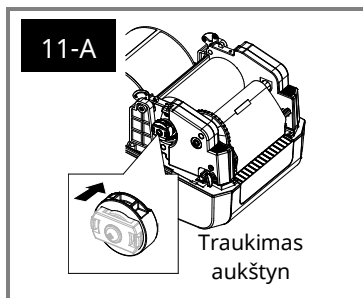
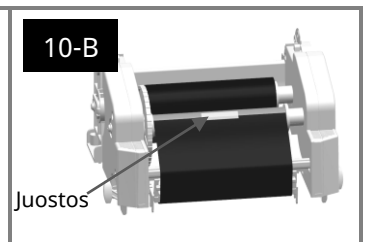
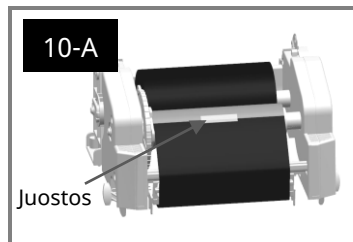
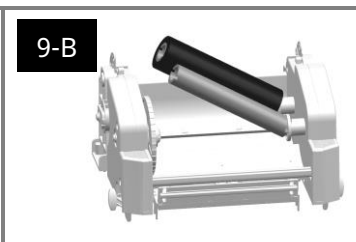
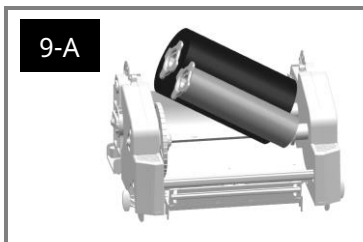
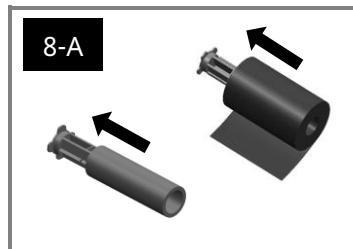
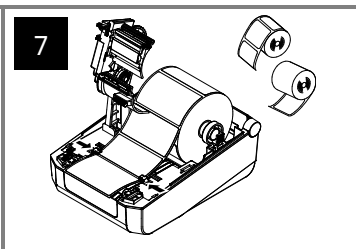
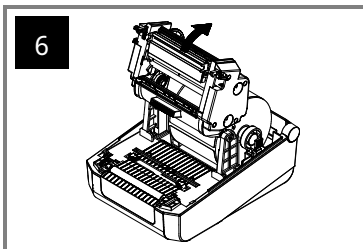
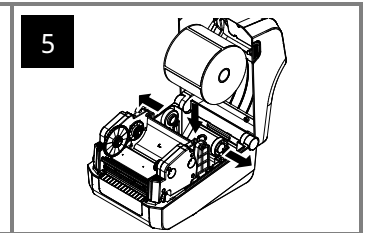
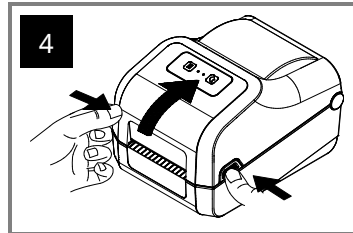
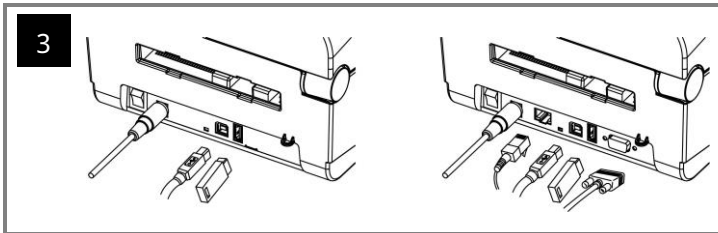
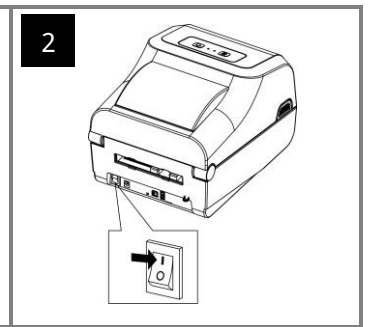
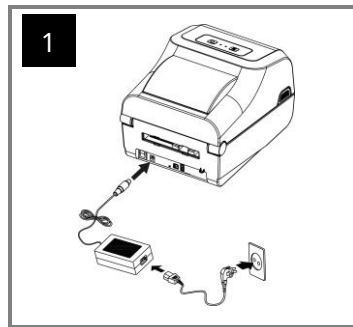
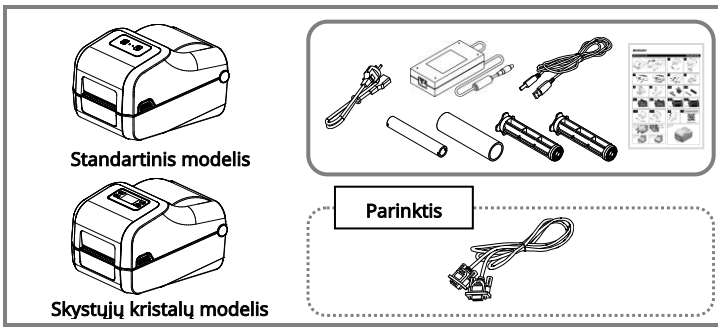

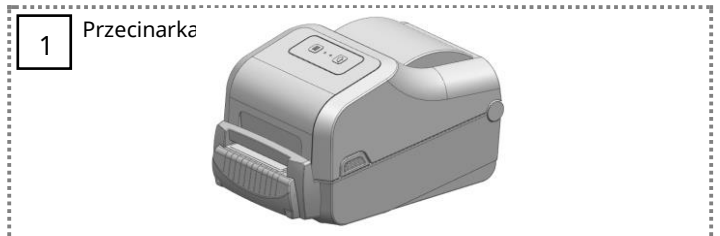
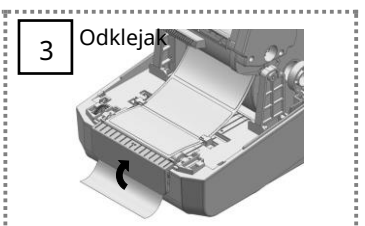
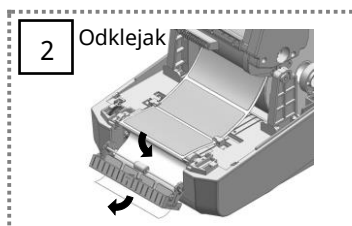
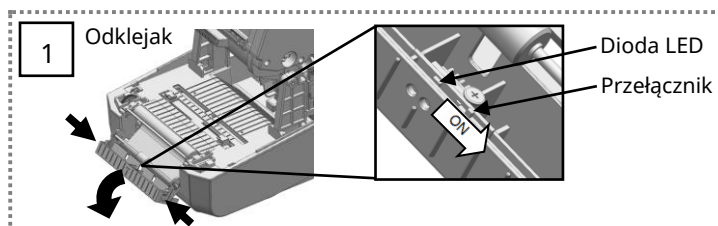
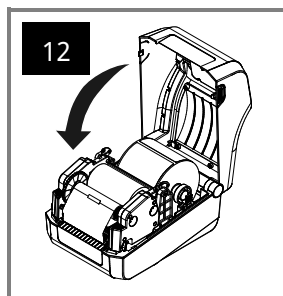
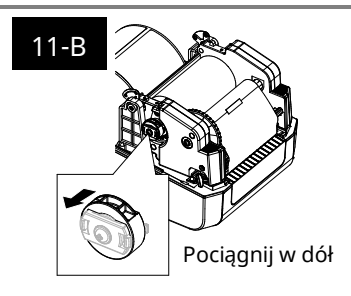
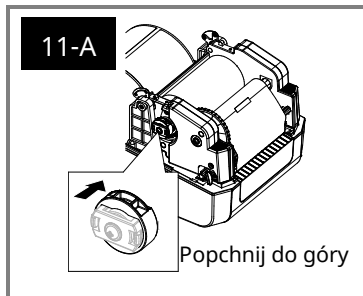
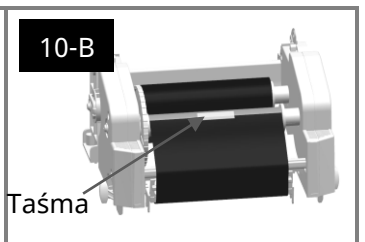
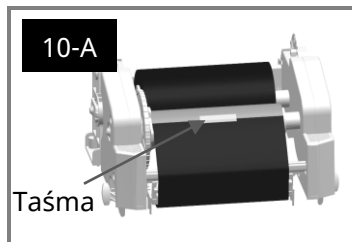
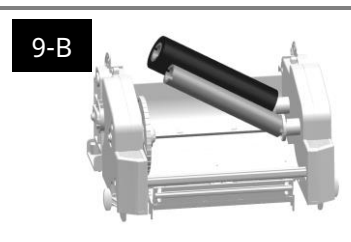
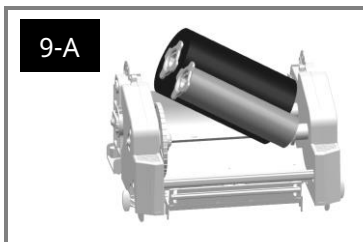
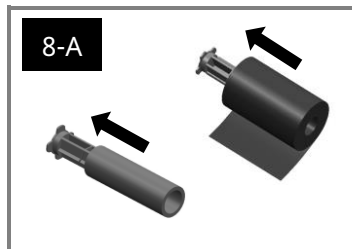
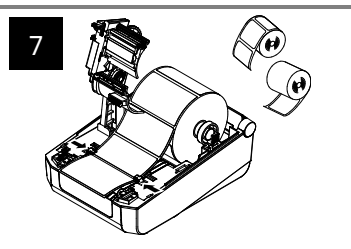
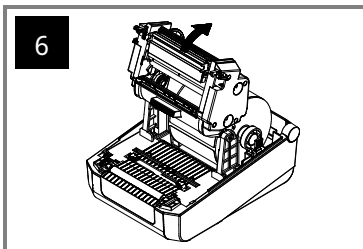
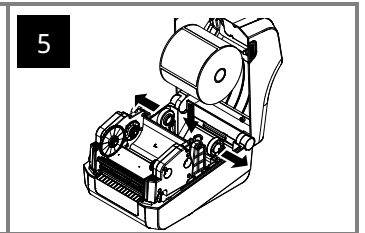
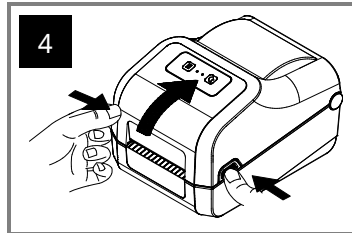
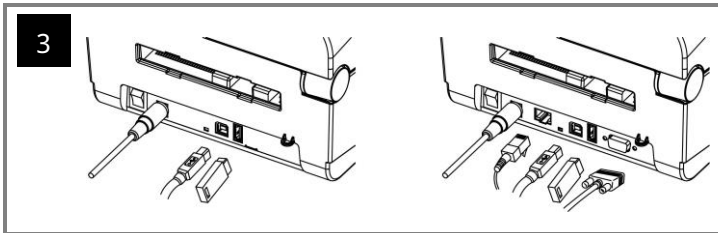
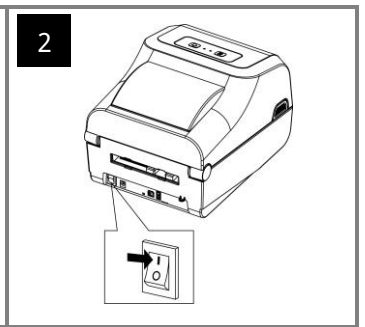
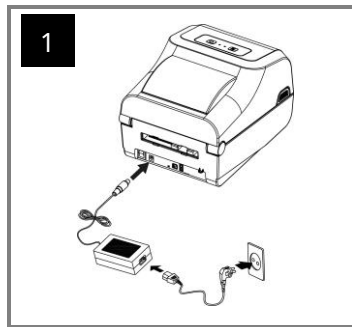
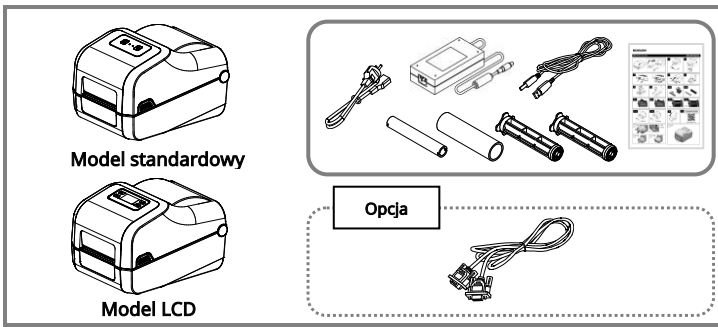



ĮSPĖJIMAI IR PERSPĖJIMAI

Apibūdinama kaip naudotojo mirtis, fiziniai sužalojimai, dideli finansiniai nuostoliai, duomenų sugadinimas ir kt.

Prie vieno maitinimo lizdo neprjunkite kelių gaminių, arba nejunkite jų, jei lizdas yra sugedęs. Naudokite tik įžemintus elektros lizdus, atitinkančius pramonės standartą. **Neatitiktumas gali sukelti elektros smūgį arba gaisrą.**



Naudokite tik autentiškus BIXOLON gaminius. **Įmonė neteiks pagalbos po pardavimo dėl sugadintų ar kitų kokybės problemų, su kuriomis gali susidurti padirbtį (arba atnaujintą) gaminiui.**



Pernelyg nelenkite ir neįtempkite maitinimo laido. Saugiai įstumkite maitinimo laidą iki galo į maitinimo lizdą, kad jis neatsilaisvintų.

Atjungdami laidą nuo maitinimo lizdo būtinai tvirtai laikykite jį už laido. Neišimkite maitinimo laido, kol gaminyje naudojamas. **Neatitiktumas gali sukelti elektros smūgį arba gaisrą.**



Mažus priedus ar kitas pakavimo medžiagas laikykite atokiau nuo mažų vaikų. Saugokitės: pavojus užspringti. **Netinkamai elgiamiesi su gaminiu galite susižeisti, todėl gali tekti skubiai kreiptis į gydytoją.**



Saugokitės, kad prie maitinimo laido ir lizdo nepatektų skysčių. Jei ant maitinimo laido pateko medžiagos, nuvalykite sausu skudurėliu. **Neatitiktumas gali sukelti elektros smūgį arba gaisrą.**



Neleiskite, kad gaminį pažeistų sunkūs daiktai. **Neatitiktumas gali sukelti elektros smūgį arba gaisrą.**



Jei gaminyje sklinda keistas garšas, degėsių kvapas arba dūmus, nedelsdami išjunkite maitinimą ir atjunkite maitinimo laidą. Jei gaminyje nukrito arba buvo pažeistas jo išorė, nedelsdami išjunkite maitinimą ir atjunkite maitinimo laidą. **Neleiskite produktui patirti smūgių. Dėl to gali būti pažeistas gaminyje arba kiti gaisras.**



Gaminį montuokite gerai vėdinamoje vietoje, laikydami jį tam tikru atstumu nuo sienos. Įrengus gaminį tam tikroje vietoje, kuriose yra per didelis drėgnumas, dūmės ir temperatūros svyravimų kiekis, arba naudojant gaminį ekstremaliomis sąlygomis, spausdintuvus gali būti sugadinti. Vidinių sąnaudų padidėjimas temperatūra gali sukelti gaisrą. **Būtinai kreipkitės į pirkimo vietą, jei nesate tikri dėl produkto patikimumo.**



Gaminį sumontuokite fiksuotoje vietoje, kad jis neapvirstų. Judindami gaminį, išjunkite maitinimą ir atjunkite visus prijungtus kabelius, įskaitant maitinimo laidą. **Kito atveju, tai gali sugadinti gaminį.**



Niekada savarankiškai neardykite, neremontuokite ir nemodifikuokite gaminių, nes garantija nustos galioti. **Jei reikia atlikti remontą, kreipkitės į pirminę pirkimo vietą.**



Neleiskite jokioms pašalinėms medžiagoms patekti ant produkto. Ant gaminio nedėkite sunkių daiktų, skysčių ar metalų. **Dėl to gali būti pažeistas gaminyje arba kiti gaisras.**



Jei su gaminiu iškilo problema, kreipkitės į pirminę pirkimo vietą arba BIXOLON svetainės gaminio remonto puslapį (www.bixolon.com).



OSTRZEŻENIE I PRZESTROGA

Sygnalizuje niebezpieczeństwo śmierci, obrażeń fizycznych, poważnych strat finansowych, uszkodzenia danych itp. dla użytkownika.

Nie podłączaj wielu urządzeń do jednego gniazdka zasilania lub do wadliwego gniazdka zasilania. Należy używać wyłącznie uzziemionych gniazdek elektrycznych spełniających normy branżowe. **Nieprzestrzeganie tego zalecenia może spowodować porażenie prądem elektrycznym lub pożar.**



Należy używać wyłącznie oryginalnych produktów firmy BIXOLON. **Firma nie zapewnia wsparcia posprzedażowego w przypadku uszkodzeń lub innych problemów związanych z jakością, które mogą wystąpić w przypadku podrobionych (lub regenerowanych) produktów.**



Nie należy nadmiernie zginąć ani naciskać przewodu zasilającego. Przewód zasilający należy wcisnąć do końca do gniazdka, aby nie pozostał luźny. Podczas odłączania przewodu od gniazda zasilania należy go mocno trzymać. Nie wolno odłączać przewodu zasilającego podczas używania urządzenia. **Nieprzestrzeganie tego zalecenia może spowodować porażenie prądem elektrycznym lub pożar.**



Drobne akcesoria lub inne materiały opakowaniowe należy przechowywać z dala od małych dzieci. Uwaga: ryzyko zadławienia. **Niewłaściwe obchodzenie się z urządzeniem może spowodować obrażenia wymagające pilnej pomocy medycznej.**



Nadmierne ilości cieczy należy przechowywać z dala od przewodu zasilającego i gniazdka. W przypadku zabrudzenia przewodów zasilających należy wytrzeć je suchą szmatką. **Nieprzestrzeganie tego zalecenia może spowodować porażenie prądem elektrycznym lub pożar.**



Nie dopuścić do uszkodzenia urządzenia przez ciężkie przedmioty. **Nieprzestrzeganie tego zalecenia może spowodować porażenie prądem elektrycznym lub pożar.**



Jeżeli z produktu wydobywa się dziwny odgłos, zapach spalenizny lub dym, należy natychmiast wyłączyć zasilanie i odłączyć przewód zasilający. W przypadku upuszczenia urządzenia lub uszkodzenia jego obudowy należy natychmiast wyłączyć zasilanie i odłączyć przewód zasilający. **Nie narażać urządzenia na wstrząsy. Mogłoby to spowodować uszkodzenie urządzenia lub pożar.**



Urządzenie należy zainstalować w dobrze wentylowanym miejscu, w pewnej odległości od ściany. Instalacja produktu w środowisku, w którym występuje nadmierne zapalenie, wilgoć i wahania temperatury lub wyjątkowo intensywne użytkowanie urządzenia może spowodować uszkodzenie drukarki lub pożar. Wzrost temperatury wewnętrznej może wywołać pożar. **W razie wątpliwości co do umieszczenia urządzenia należy skontaktować się z punktem sprzedaży.**



Urządzenie należy zainstalować w stałym miejscu, aby zapobiec jego przewróceniu. Podczas przenoszenia urządzenia należy wyłączyć zasilanie i odłączyć wszystkie przewody podłączone do urządzenia, w tym przewód zasilający. **Może to spowodować uszkodzenie urządzenia.**



Nigdy nie należy samodzielnie demontować, naprawiać ani modyfikować urządzenia, ponieważ spowoduje to utratę gwarancji. **W razie konieczności naprawy należy skontaktować się z oryginalnym miejscem zakupu.**



Nie dopuszczaj do przedostania się ciał obcych do wnętrza urządzenia. Nie umieszczaj na urządzeniu ciężkich przedmiotów, cieczy ani metalu. **Mogłoby to spowodować uszkodzenie urządzenia lub pożar.**



W razie wystąpienia problemu z produktem należy skontaktować się z oryginalnym miejscem zakupu lub za pośrednictwem strony napraw produktów w witrynie internetowej firmy BIXOLON (www.bixolon.com).



Lithuanian

Polish

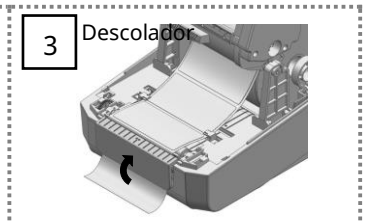
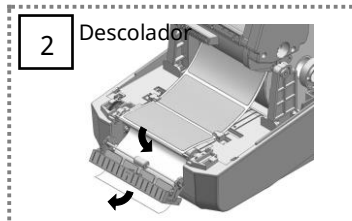
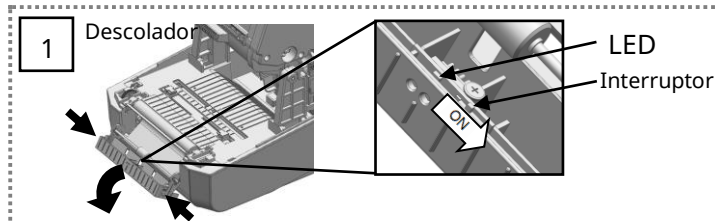
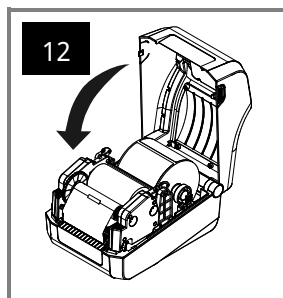
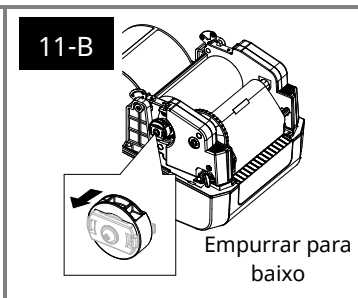
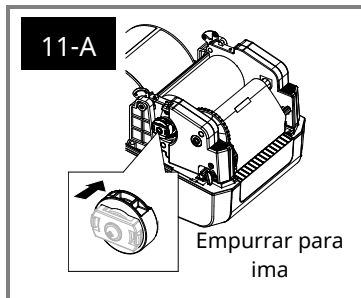
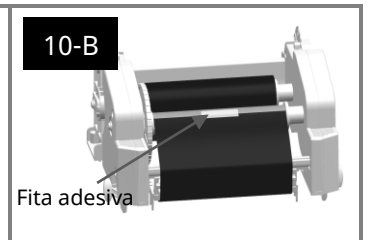
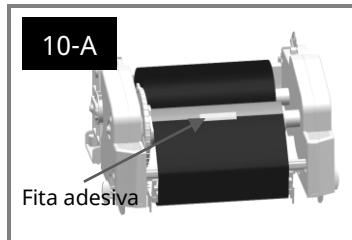
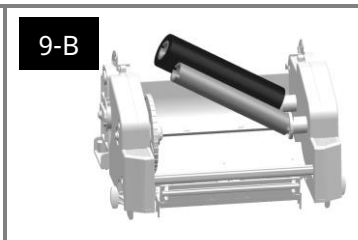
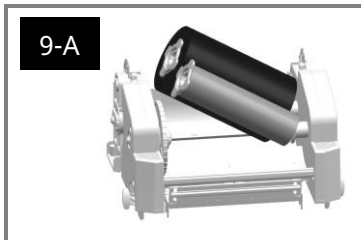
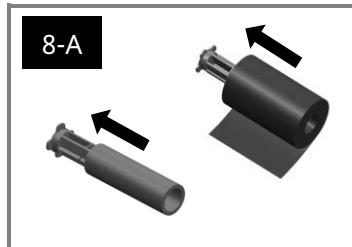
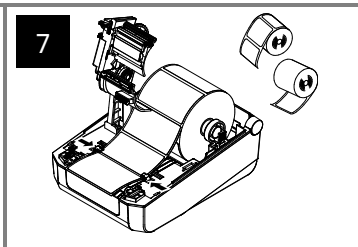
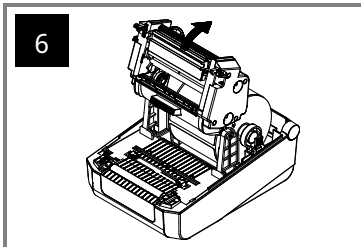
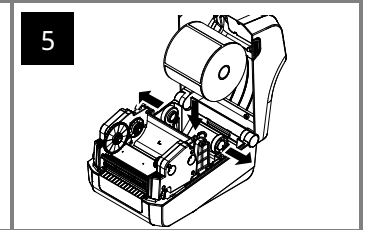
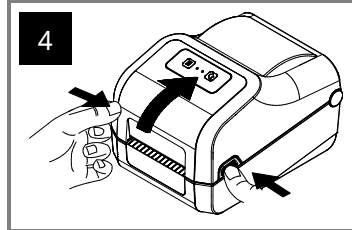
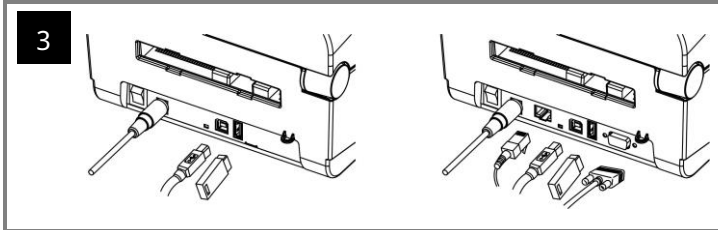
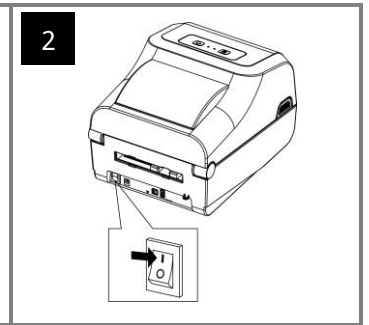
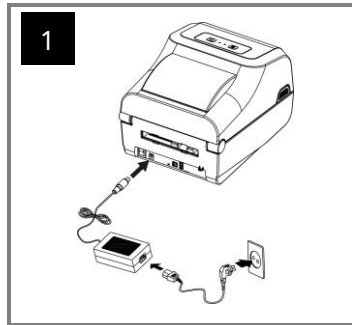
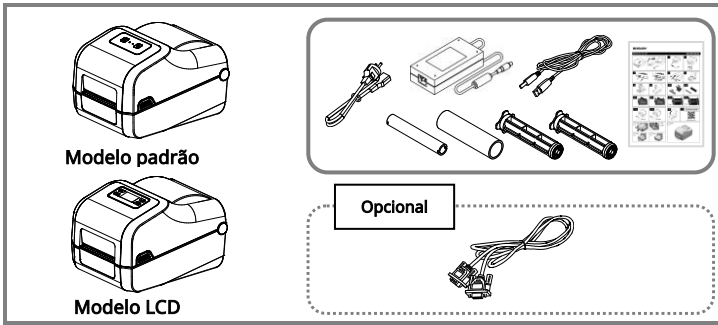

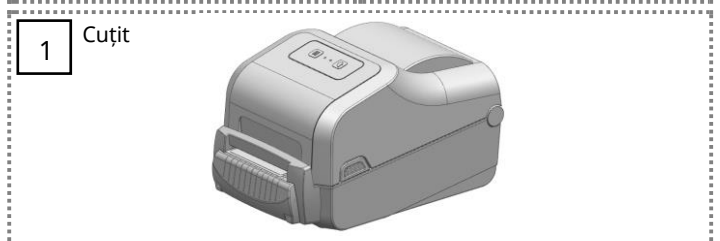
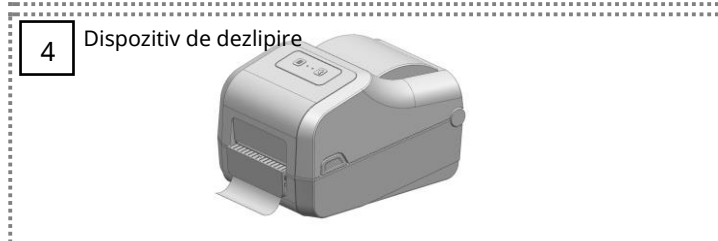
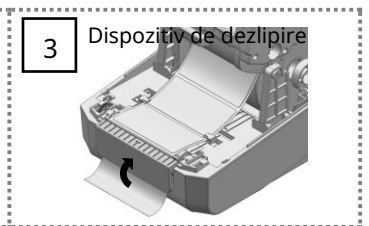
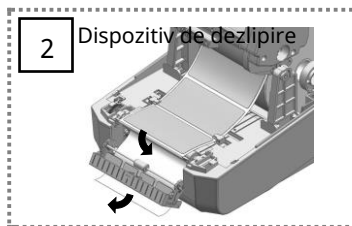
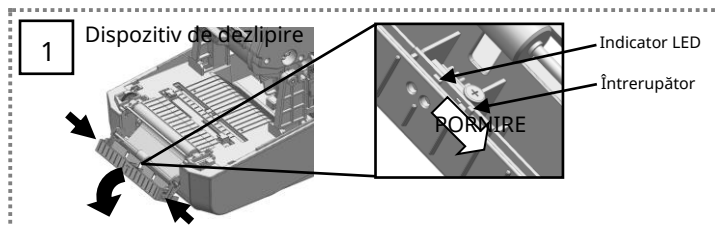
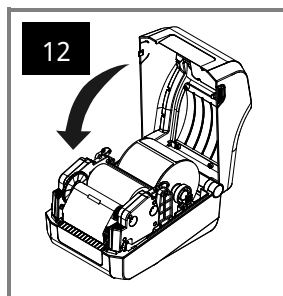
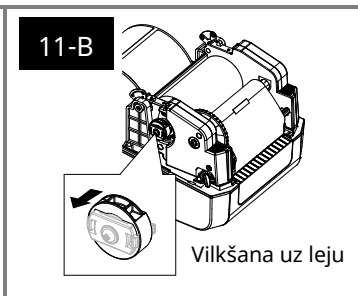
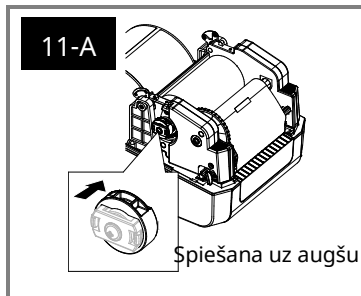
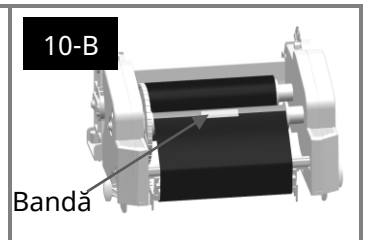
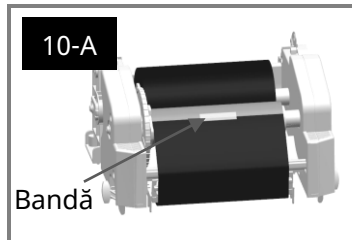
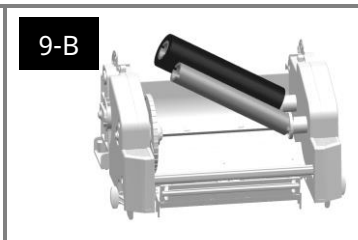
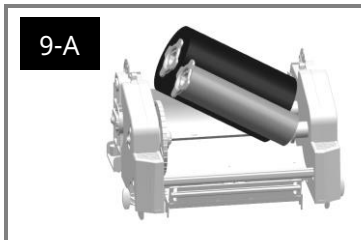
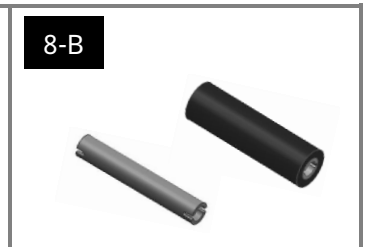
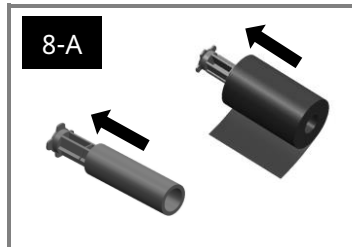
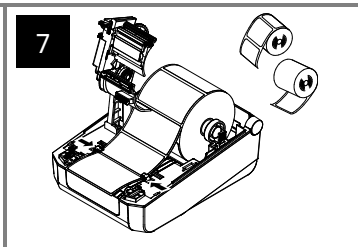
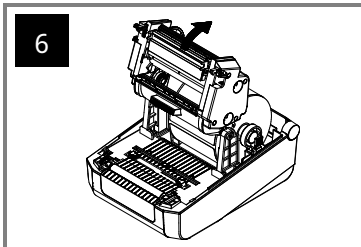
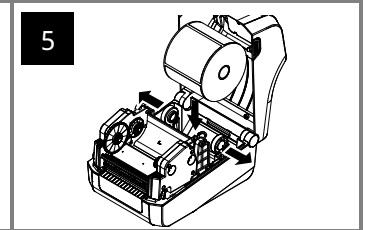
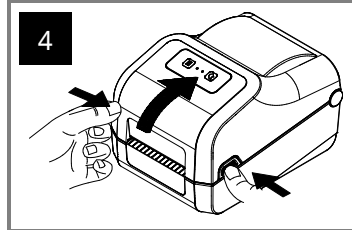
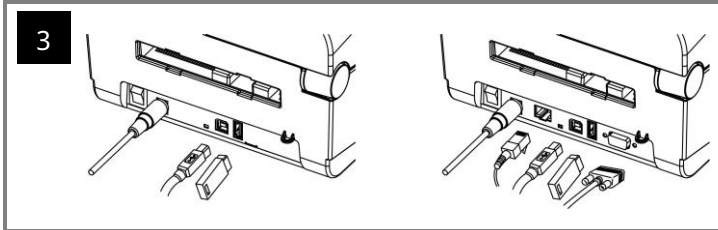
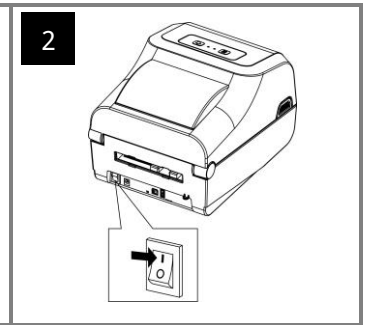
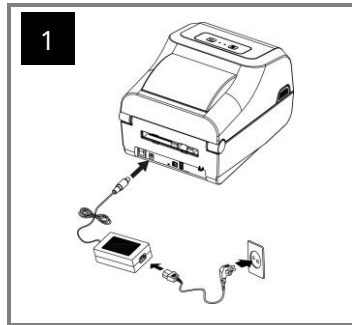
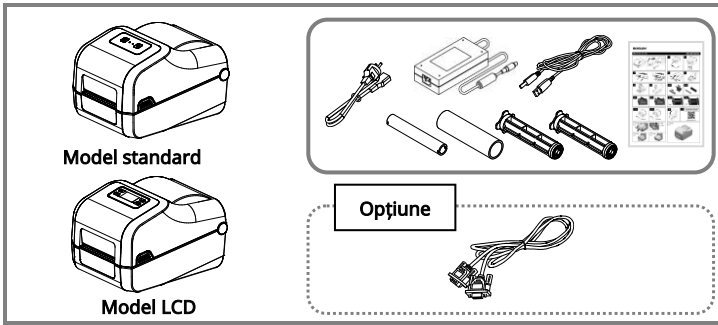



AVISO E CUIDADO

É descrito como situações como morte, ferimentos, prejuízos financeiros de grande monta e danos nos dados, entre outros, que podem ser causados ao utilizador.

Não ligue vários produtos a uma tomada elétrica danificada ou individual. Utilize apenas tomadas com ligação à terra que cumpram com as normas da indústria. **O desrespeito pelo mencionado anteriormente pode levar ao risco de choques elétricos e incêndio.**



Use apenas produtos originais da BIXOLON. **A empresa não irá fornecer serviço pós-venda por danos ou outros problemas resultantes da utilização de produtos de concorrência (ou recondicionados).**



Não dobre ou cause tensões excessivas no cabo de alimentação. Empurre com cuidado o cabo de alimentação totalmente em direção à tomada elétrica, para que a ligação seja segura. Certifique-se de que segura o cabo com firmeza ao separá-lo da tomada elétrica. Não remova o cabo de alimentação enquanto estiver a utilizar o produto. **O desrespeito pelo mencionado anteriormente pode levar ao risco de choques elétricos e incêndio.**



Mantenha acessórios pequenos ou outros materiais de embalagem afastados de crianças pequenas. Cuidado: perigo de asfixia. **O manuseamento incorreto do produto pode causar ferimentos suscetíveis de serem necessários cuidados médicos urgentes.**



Mantenha líquidos em excesso afastados do cabo de alimentação e da tomada. Se os elementos entrarem em contacto com os cabos de alimentação, limpe-os com um pano seco. **O desrespeito pelo mencionado anteriormente pode levar ao risco de choques elétricos e incêndio.**

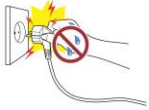

Não permita que o produto fique danificado devido a objetos pesados. **O desrespeito pelo mencionado anteriormente pode levar ao risco de choques elétricos e incêndio.**



Se o produto emitir um som estranho, odor a queimado ou fumo, desligue-o da corrente imediatamente e retire o cabo de alimentação da tomada. Se o produto tiver quente ou o seu exterior estiver danificado, desligue-o da corrente imediatamente e retire o cabo de alimentação da tomada. **Não sujeite o produto a impactos. Tal poderá danificar o produto ou originar um incêndio.**



Instale o produto numa área bem ventilada, mantendo-o a uma certa distância da parede. Instalar o produto em determinados ambientes que são propensos a pó excessivo, humidade e a flutuações de temperatura ou colocar o produto sob uso extremo pode causar danos à impressora. **Um aumento da temperatura interna pode levar a um incêndio. Certifique-se de contactar o local de compra se não tiver certeza sobre a colocação do produto.**



Instale o produto num local estável, de forma a evitar que este caia. Quando mover o produto, desligue-o da corrente e retire todos os cabos ligados, incluindo o cabo de alimentação. **Isto pode danificar o produto.**



Não desmonte, repare ou altere o produto por iniciativa própria. Ao fazê-lo, irá invalidar a garantia. **Se for necessária uma reparação, contacte o ponto de compra original.**



Não permita que nenhuma substância estranha entre dentro do produto. Não coloque objetos pesados, líquidos ou metais sobre o produto. **Tal poderá danificar o produto ou originar um incêndio.**



Se existir um problema com o produto, entre em contacto com o ponto de compra original ou através da página de reparações de produtos do site Web da BIXOLON (www.bixolon.com).



AVERTISMENT ȘI ATENȚIONĂRI

Indică evenimente precum deces, vătămări fizice, pierderi financiare grave și deteriorare a datelor etc. pe care le poate suferi utilizatorul.

Nu conectați mai multe produse la o singură priză sau la o priză defectă. Utilizați numai prize cu împământare, care îndeplinesc standardele din domeniu. **Nerespectarea acestei prevederi poate provoca electrocutare sau incendiu.**



Folosiți numai produse autentice de la BIXOLON. **Compania nu va oferi asistență post-vânzare pentru problemele legate de deteriorări sau alte probleme de calitate, care pot apărea ca urmare a unor produse false (sau recondiționate).**



Nu îndoiți și nu întindeți excesiv cablul de alimentare. Împingeți bine cablul de alimentare până la capăt în priză de alimentare astfel încât să nu atârne. Asigurați-vă că țineți bine de cablu atunci când îl trageți din priză. Nu scoateți cablul de alimentare în timp ce produsul este în uz. **Nerespectarea acestei prevederi poate provoca electrocutare sau incendiu.**



Țineți accesoriile mici sau alte materiale de ambalare departe de copiii mici. Atenție: pericol de sufocare. **Manipularea greșită a produsului poate provoca răni care pot necesita solicitarea de asistență medicală urgentă.**



Țineți lichidele departe de cablul de alimentare și de priză. Dacă lichidul ajunge pe cablurile de alimentare, ștergeți cu o lavetă uscată. **Nerespectarea acestei prevederi poate provoca electrocutare sau incendiu.**



Nu permiteți ca produsul să fie deteriorat de obiecte grele. **Nerespectarea acestei prevederi poate provoca electrocutare sau incendiu.**

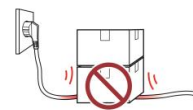

Dacă produsul emite un sunet neobișnuit, degajă miros de ars sau fum, opriți imediat alimentarea și deconectați cablul de alimentare. Dacă produsul a căzut sau exteriorul său este deteriorat, opriți imediat alimentarea și deconectați cablul de alimentare. Nu supuneți produsul la socuri. **Acest lucru ar putea cauza deteriorarea produsului sau un incendiu.**



Instalați produsul într-o zonă bine aerisită, lăsând o anumită distanță față de perete. Instalarea produsului în anumite medii care sunt predispuși la praf excesiv, umiditate și fluturări de temperatură sau utilizarea excesivă a produsului poate cauza deteriorarea imprimantei. O creștere a temperaturii interne poate declanșa un incendiu. **Asigurați-vă că luați legătura cu locul de unde ați achiziționat produsul dacă aveți nelămuriri cu privire la locul în care trebuie instalat.**



Instalați produsul într-un loc fix, pentru a preveni răsturnarea acestuia. Când mutați produsul, opriți alimentarea și deconectați toate cablurile conectate, inclusiv cablul de alimentare. **În caz contrar, produsul poate fi deteriorat.**



Nu dezasamblați, nu reparați și nu modificați niciodată produsul pe cont propriu, deoarece acest lucru duce la anularea garanției. **Când este necesară repararea, contactați locul de unde ați achiziționat inițial produsul.**



Nu lăsați nicio substanță străină să pătrundă în produs. Nu așezați obiecte grele, lichide sau metale pe produs. **Acest lucru ar putea cauza deteriorarea produsului sau un incendiu.**









Dacă există o problemă cu produsul, contactați locul de unde ați achiziționat inițial produsul sau accesați pagina de reparații a produsului, de pe site-ul web BIXOLON (www.bixolon.com).

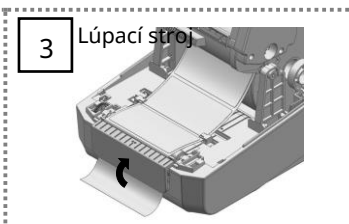
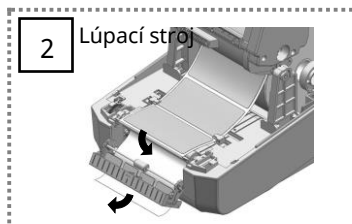
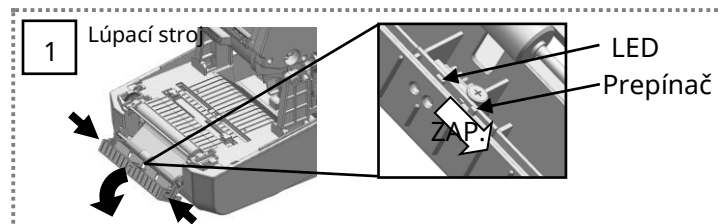
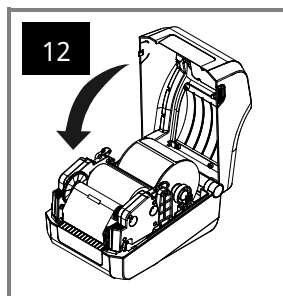
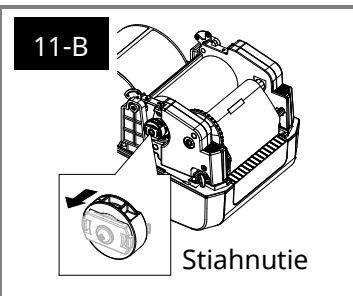
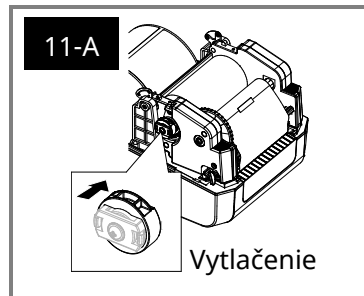
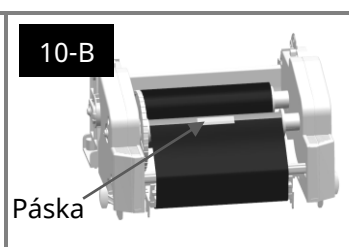
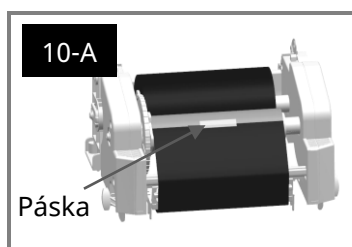
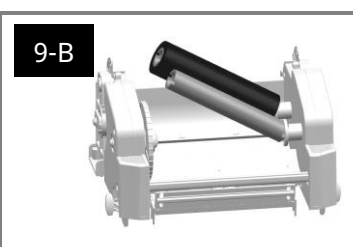
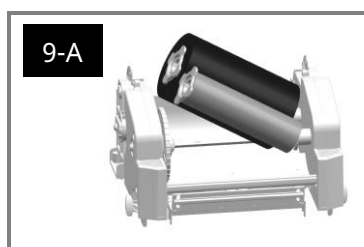
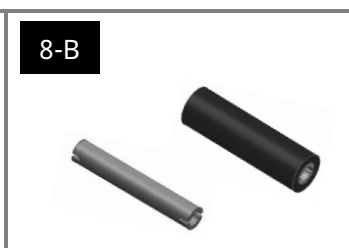
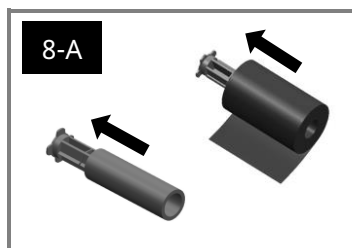
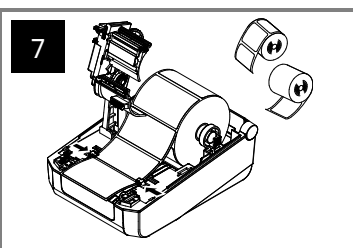
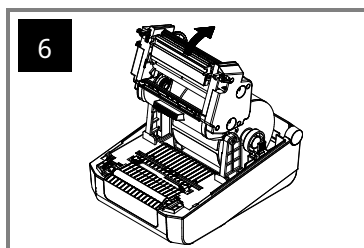
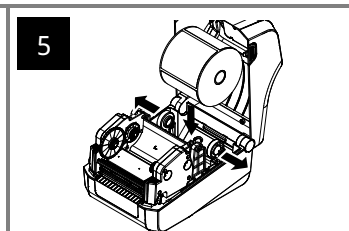
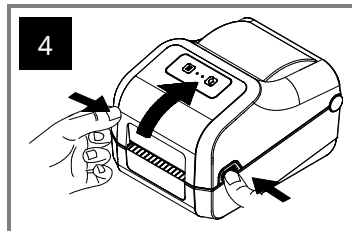
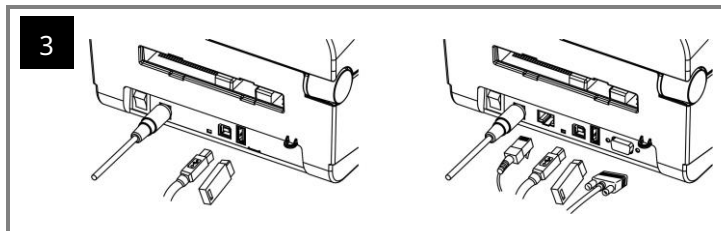
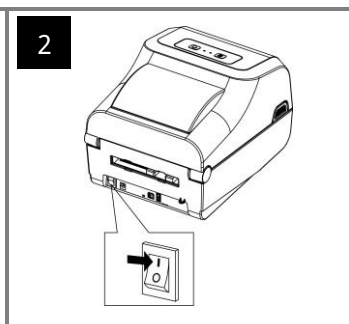
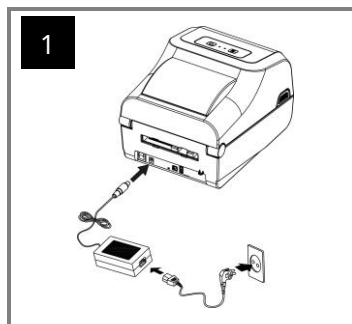
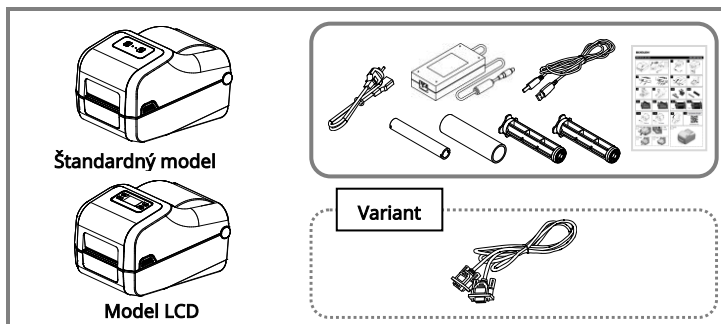

Portuguese

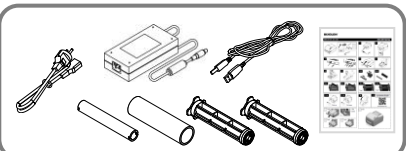
Romanian



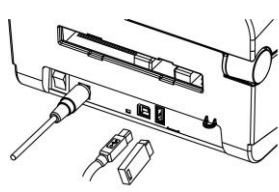
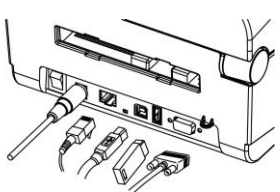

 <p>Standardni model</p>  <p>Model LCD</p>	 <p>Možnost</p> 	<p>1</p> 	<p>2</p> 
--	--	---	--

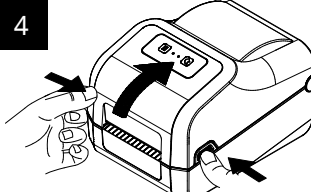
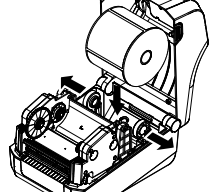
<p>3</p> 	
--	---

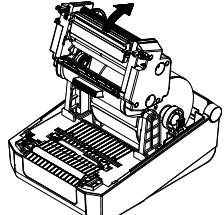
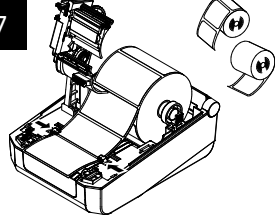
<p>4</p> 	<p>5</p> 
---	--

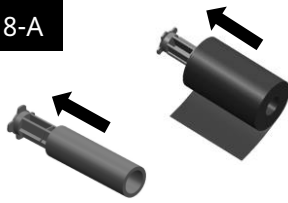

<p>6</p> 	<p>7</p> 
---	---

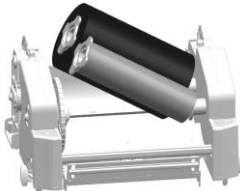
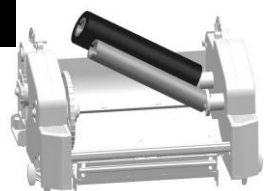
<p>8-A</p> 	<p>8-B</p> 
--	---

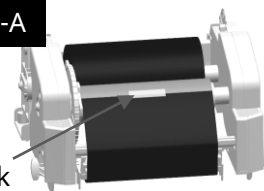
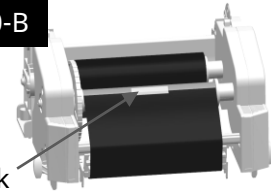
<p>9-A</p> 	<p>9-B</p> 
--	--

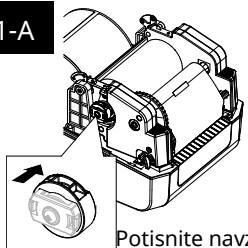
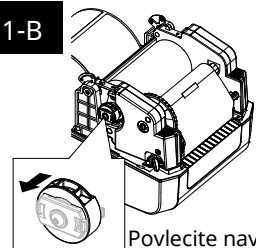
<p>10-A</p>  <p>Trak</p>	<p>10-B</p>  <p>Trak</p>
--	---

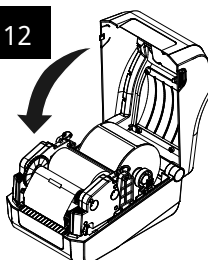
<p>11-A</p>  <p>Potisnite navzgor</p>	<p>11-B</p>  <p>Povlecite navzdol</p>
--	--

<p>12</p> 	<p>13</p> <p>Če želite prenesti več informacij, obiščite spletno mesto BIXOLON.</p> 
--	---

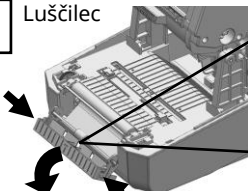
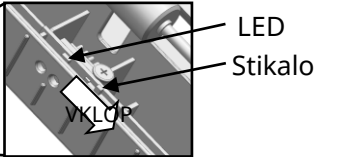
<p>1</p> <p>Luščilec</p> 	 <p>LED</p> <p>Stikalo</p> <p>VKLON</p>
--	--

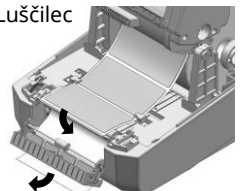
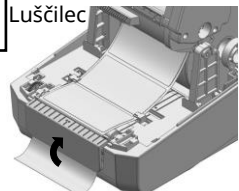
<p>2</p> <p>Luščilec</p> 	<p>3</p> <p>Luščilec</p> 
---	--

<p>4</p> <p>Luščilec</p> 
--

<p>1</p> <p>Rezalnik</p> 
--



VAROVANIE A UPOZORNENIE

Je opísaný ako smrť, fyzické zranenia, vážne finančné straty, poškodenie údajov atď., ktoré môžu byť spôsobené používateľovi.

Nepripájajte viacero výrobkov do jednej alebo chybné elektrickej zásuvky. Používajte iba uzemnené elektrické zásuvky, ktoré spĺňajú normu odvetvia. **Nedodržanie pravidiel môže spôsobiť úraz elektrickým prúdom alebo požiar.**



Používajte iba autentické produkty spoločnosti BIXOLON. **Spoločnosť nebude poskytovať podporu po predaji v prípade poškodených alebo iných problémov s kvalitou, ktoré môžu vzniknúť falšovaným (alebo renovovaným) výrobkom.**



Napájací kábel nadmerne neohýbajte ani nenamáhajte. Bezpečné zatláčte napájací kábel úplne do elektrickej zásuvky, aby nezostal voľný. Pri vyťahovaní kábla z elektrickej zásuvky ho pevne držte. Počas používania výrobku napájací kábel neodpájajte. **Nedodržanie pravidiel môže spôsobiť úraz elektrickým prúdom alebo požiar.**



Malé doplnky alebo iné obalové materiály uchovávajte mimo dosahu malých detí. Pozor: nebezpečenstvo udusenia. **Nesprávna manipulácia s výrobkom môže spôsobiť zranenia, ktoré si môžu vyžadovať naliehavú lekársku pomoc.**



Prebytočné tekutiny uchovávajte mimo dosahu napájacieho kábla a zásuvky. Ak je na napájacie káble rozmazaná hmota, utrite suchou handričkou. **Nedodržanie pravidiel môže spôsobiť úraz elektrickým prúdom alebo požiar.**

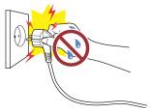

Nedovoľte, aby bol výrobok poškodený ťažkými predmetmi. **Nedodržanie pravidiel môže spôsobiť úraz elektrickým prúdom alebo požiar.**



Ak výrobok vydáva zvláštny zvuk, zápach pálenia alebo dym, okamžite vypnite napájanie a odpojte napájací kábel. Ak výrobok spadne alebo sa poškodí jeho vonkajšia strana, okamžite vypnite napájanie a odpojte napájací kábel. Nevystavujte výrobok nárazom. **Mohlo by to spôsobiť poškodenie výrobku alebo požiar.**



Výrobok inštalujte na dobre vetranom mieste tak, že ho budete udržiavať v určitej vzdialenosti od steny. Inštalácia výrobku v určitých prostrediach, ktoré sú náchylné na nadmernú prašnosť, vlhkosť a teplotné výkyvy, alebo extrémne používanie výrobku môže spôsobiť jeho poškodenie. Zvýšenie viditeľnej teploty môže spôsobiť požiar. **Nezabudnite kontaktovať miesto nákupu, ak si nie ste istí umiestnením produktu.**



Nainštalujte výrobok na pevné miesto, aby ste zabránili jeho prevráteniu. Pri premiestňovaní výrobku vypnite napájanie a odpojte všetky pripojené káble vrátane napájacieho kábla. **Pretože by to mohlo poškodiť výrobok.**



Produkt nikdy samostatne nerozoberajte, neopravujte ani neupravujte, pretože záruka zanikne. **Ak je potrebná oprava, obráťte sa na pôvodné miesto nákupu.**



Nedovoľte, aby do výrobku vnikli žiadne cudzie látky. Na výrobok neumiestňujte ťažké predmety, kvapaliny ani kovy. **Mohlo by to spôsobiť poškodenie výrobku alebo požiar.**



Ak sa vyskytne problém s produktom, obráťte sa na pôvodné miesto nákupu alebo prostredníctvom stránky opravy produktu na webovej stránke spoločnosti BIXOLON (www.bixolon.com).



OPOZORILO IN PREVIDNOST

To pomeni smrt, telesne poškodbe, hude finančne izgube in poškodbe podatkov itd., ki jih lahko povzročí uporabnik.

Ne priključite več izdelkov na eno ali pokvarjeno vtičnico. Uporabljajte le ozemljene vtičnice, ki ustrezajo industrijskim standardom. **Neupoštevanje navedenega lahko povzroči električni udar ali požiar.**



Uporabljajte samo pristne izdelke družbe BIXOLON. **Podjetje ne bo zagotovilo poprodajne podpore za poškodovane izdelke ali druge težave s kakovostjo, ki jih lahko povzročijo ponarejeni (ali obnovljeni) izdelki.**



Napajalnega kabela ne upogibajte ali napačajte preveč. Napajalni kábel dobro potisnite povsem v električno vtičnico, da ne ostane zrahljan. Poskrbite, da kábel ob iztikanju iz vtičnice trdno držite. Ne odstranjujte napajalnega kábla, ko je izdelek v uporabi. **Neupoštevanje navedenega lahko povzroči električni udar ali požiar.**



Majhne dodatke ali drugo embalažo hranite izven dosega majhnih otrok. Pozor: nevarnost zadušitve. **Nepravilno ravnanje z izdelkom lahko povzroči telesne poškodbe, ki lahko zahtevajo nujno zdravniško pomoč.**



Ne približujte večje količine tekočin napajalnemu káblu in vtičnici. Če se po napajalnih káblah razmaže snov, jih obrišite s suho krpo. **Neupoštevanje navedenega lahko povzroči električni udar ali požiar.**



Ne dopustite, da bi izdelek poškodovali težki predmeti. **Neupoštevanje navedenega lahko povzroči električni udar ali požiar.**



Če izdelek oddaja nenavaden zvok, vonj po zažiganem ali dim, takoj izklopite napajanje in iztaknite napajalni kábel. Če vam izdelek pade ali se poškoduje njegova zunanost, takoj izklopite napajanje in iztaknite napajalni kábel. Izdelek ne izpostavljajte udarcem. **To lahko povzroči poškodbe izdelka ali požiar.**



Izdelek namestite na dobro prezračevano mesto, pri čemer ohranite določeno razdaljo med izdelkom in steno. Namestitev izdelka v nekatera okolja, ki so nagnjena k čezmernemu nastajanju prahu, vlage in temperaturnim nihanjem ali izpostavljenosti izdelka ekstremni uporabi lahko poškoduje tiskalnik. Povečanje notranje temperature lahko povzroči požiar. **Če niste prepričani glede namestitve izdelka, se obvezno obrnite na mesto nakupa.**



Izdelek namestite na fiksno mesto, da preprečite prevrnitev. Pred premikanjem izdelka izklopite napajanje in iztaknite vse priključene káble, vključno z napajalnim káblom. **Če tega ne storite, se izdelek lahko poškoduje.**



Nikoli samostojno ne razstavljajte, popravljajte ali spreminjajte izdelek, ker to izniči garancijo. **Če je potrebno popravilo, se obrnite na prvotno mesto nakupa.**



Preprečite vstop tujih snovi v izdelek. Na izdelek ne postavljajte težkih predmetov, tekočin ali kovin. **To lahko povzroči poškodbe izdelka ali požiar.**



Če pride do težave z izdelkom, se obrnite na prvotno mesto nakupa ali obiščite stran za popravilo izdelkov na spletnem mestu BIXOLON (www.bixolon.com).



Slovak

Slovenian

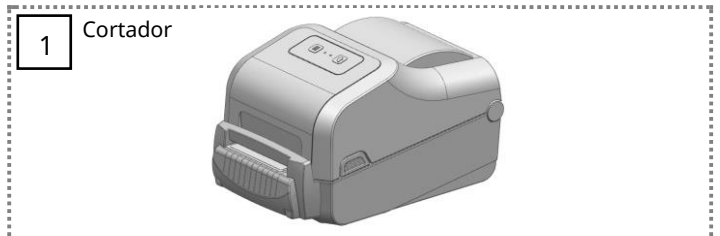
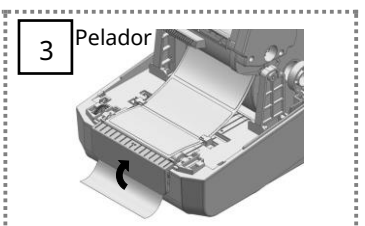
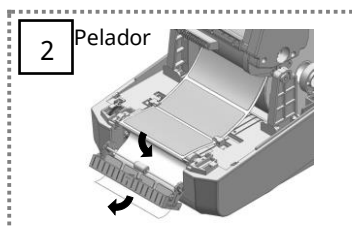
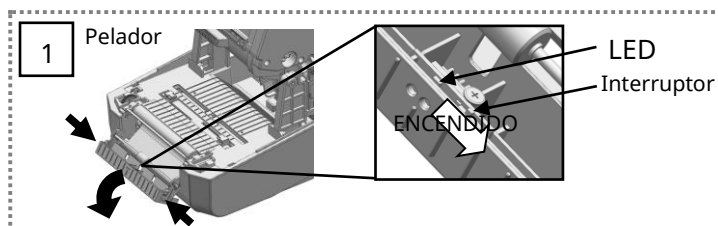
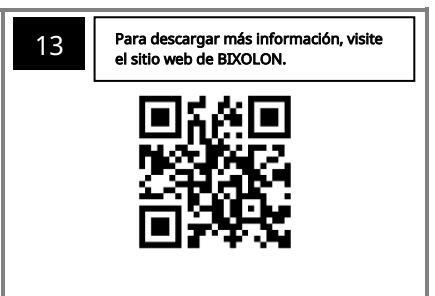
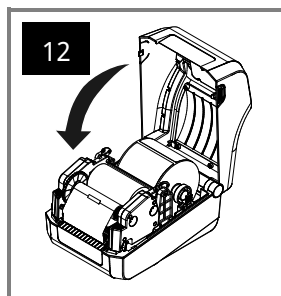
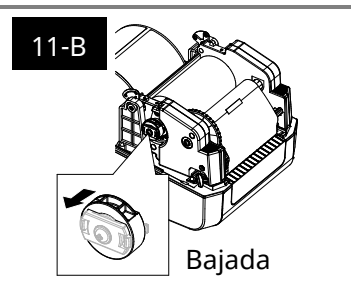
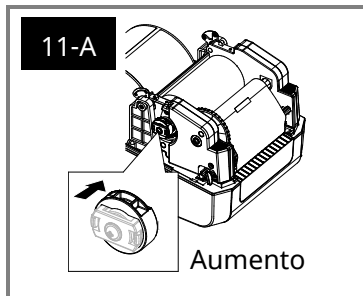
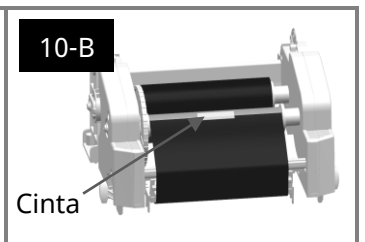
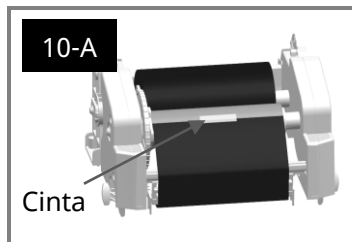
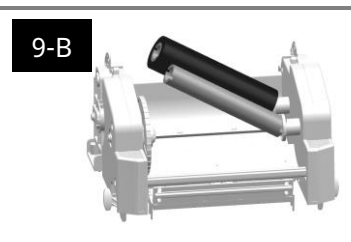
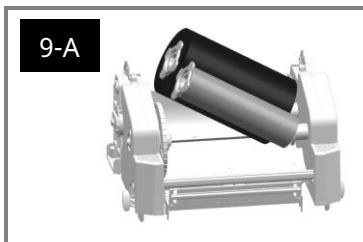
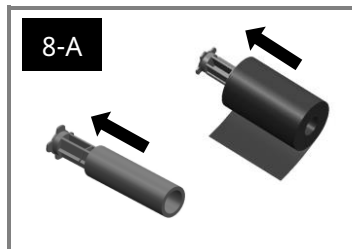
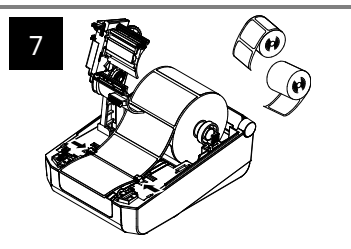
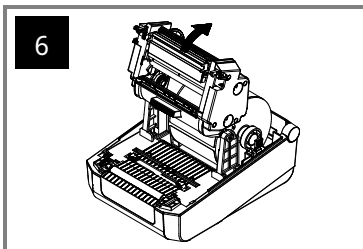
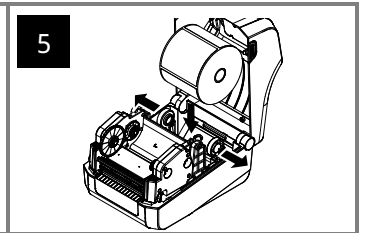
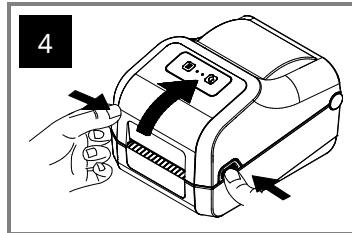
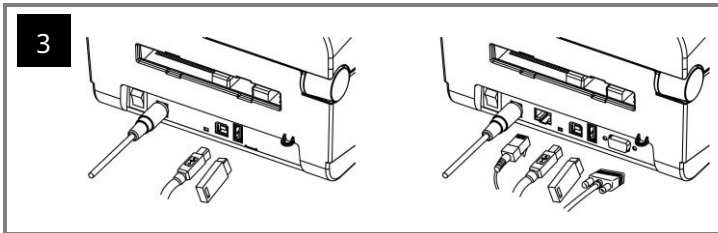
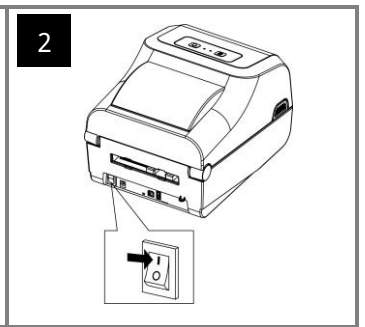
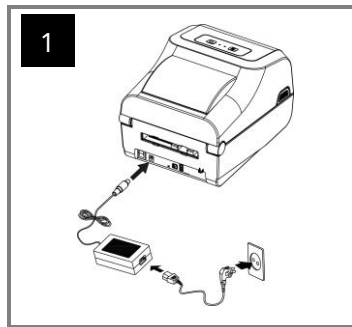
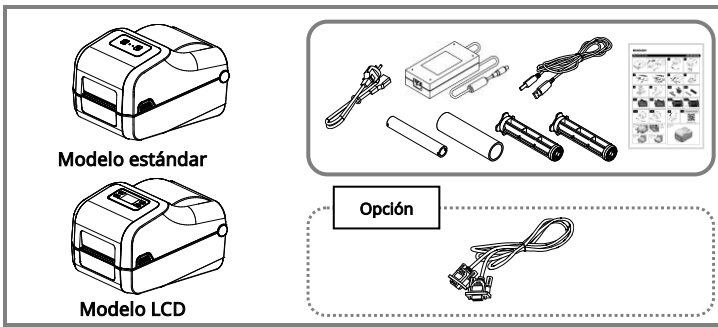

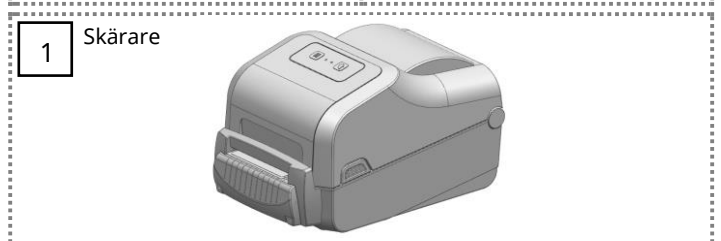
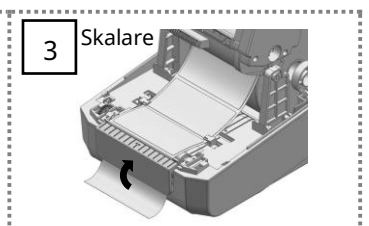
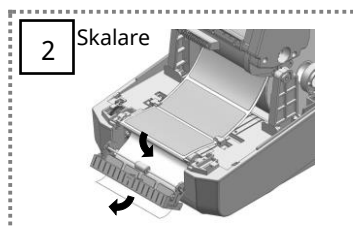
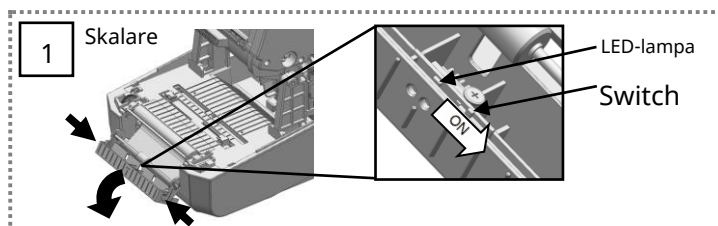
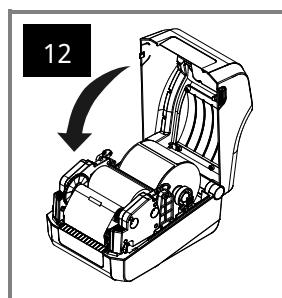
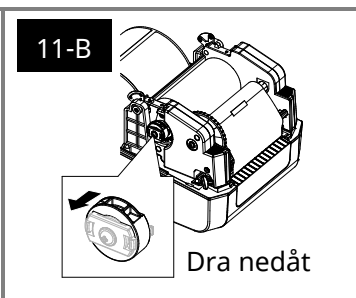
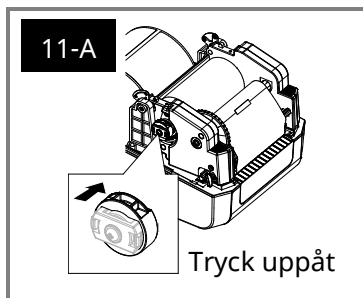
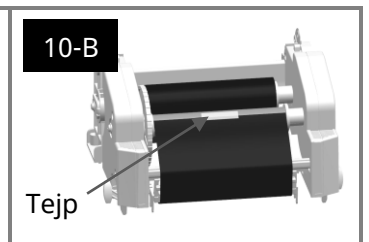
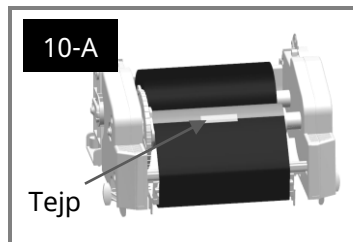
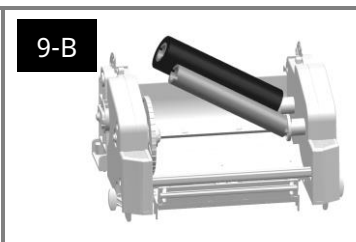
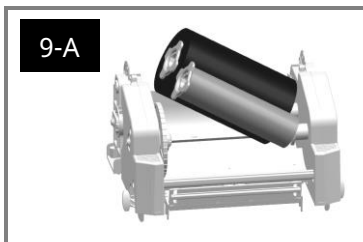
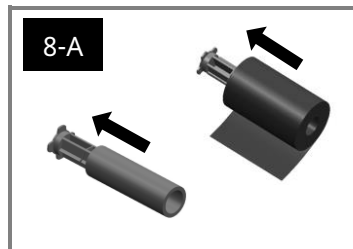
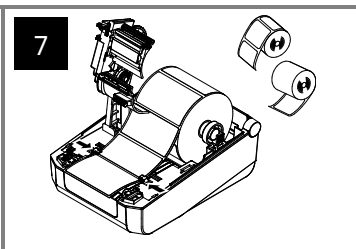
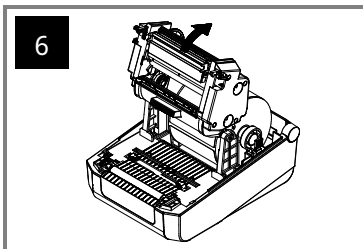
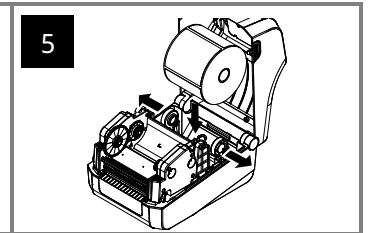
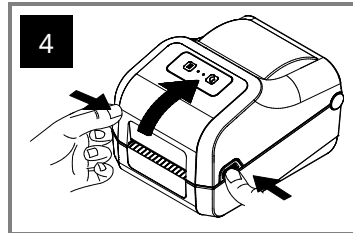
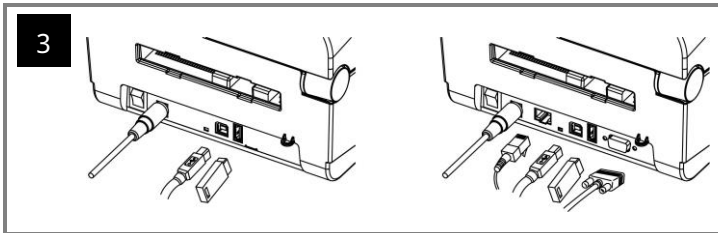
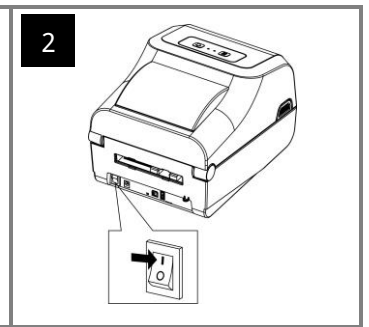
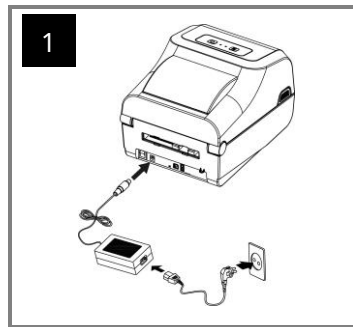
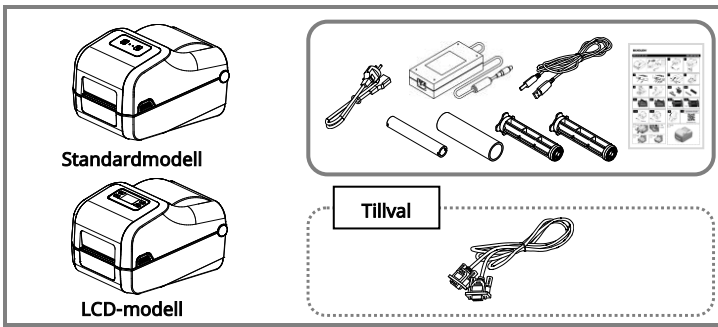



ADVERTENCIA Y PRECAUCIÓN

Se describe como muerte, lesiones físicas, pérdidas financieras graves y daños a los datos, etc., que puede sufrir el usuario.

No conecte varios productos a una toma de corriente única o defectuosa. Utilice únicamente tomas de corriente con conexión a tierra que cumplan con los estándares de la industria. **El incumplimiento puede provocar descargas eléctricas o incendios.**



Utilice únicamente productos auténticos de BIXOLON. **La empresa no proporcionará soporte posventa en caso de daños u otros problemas de calidad en los que pueda incurrir cualquier producto falso (o reacondicionado).**



No doble ni fuerce excesivamente el cable de alimentación. Empuje con seguridad el cable de alimentación hasta el fondo en la toma de corriente para que no quede suelto. Asegúrese de sujetar el cable con fuerza al separarlo de la toma de corriente. No retire el cable de alimentación mientras el producto esté en uso. **El incumplimiento puede provocar descargas eléctricas o incendios.**



Mantenga los accesorios pequeños u otros materiales de embalaje fuera del alcance de los niños pequeños. Cuidado: peligro de asfixia. **El mal manejo del producto puede provocar lesiones que pueden requerir atención médica urgente.**



Mantenga el exceso de líquidos alejado del cable de alimentación y de la toma. Si se manchan los cables de alimentación, límpielos con un paño seco. **El incumplimiento puede provocar descargas eléctricas o incendios.**



No permita que el producto se dañe con objetos pesados. **El incumplimiento puede provocar descargas eléctricas o incendios.**



Si el producto emite un sonido extraño, olor a quemado o humo, apáguelo inmediatamente y desenchufe el cable de alimentación. Si el producto se cae o su exterior se daña, apáguelo inmediatamente y desenchufe el cable de alimentación. No someta el producto a golpes. **Esto podría causar daños al producto o un incendio.**



Instale el producto en un área bien ventilada manteniéndolo a una cierta distancia de la pared. Instalar el producto en determinados entornos propensos a polvo excesivo, humedad y fluctuaciones de temperatura o someter el producto a un uso extremo puede provocar daños a la impresora. Un aumento de la temperatura interna puede provocar un incendio. **Asegúrese de comunicarse con el lugar de compra si no está seguro de la ubicación del producto.**



Instale el producto en un lugar fijo para evitar que se vuelque. Cuando mueva el producto, apáguelo y desconecte todos los cables conectados, incluido el cable de alimentación. **Puede dañar el producto.**



Nunca desmonte, repare o modifique el producto de forma independiente, ya que la garantía dejará de ser válida. **Cuando sea necesaria una reparación, comuníquese con el lugar de compra original.**



No deje que ninguna sustancia extraña entre en el producto. No coloque objetos pesados, líquidos o metales sobre el producto. **Esto podría causar daños al producto o un incendio.**



Si hay un problema con el producto, comuníquese con el lugar de compra original o a través de la página de reparación del producto del sitio web de BIXOLON (www.bixolon.com).



VARNING OCH FÖRSIKTIGHET

Beskrivs som dödsfall, fysiska skador, allvarlig ekonomiska förlust och skada på data etc. som kan orsakas användaren.

Anslut inte flera produkter till samma, eller trasiga eluttag. Använd endast jordade eluttag som uppfyller branschstandarden. **Undermåliga eluttag kan orsaka elektriska stötar eller brand.**



Använd endast äkta BIXOLON-produkter. **Företaget kommer inte att tillhandahålla support efter försäljning för skadade produkter eller andra kvalitetsproblem på eventuella falska (eller reparerade) produkter.**



Böj och belast inte strömsladden för hårt. Tryck in strömsladden ordentligt i eluttaget, så att den inte sitter löst. Håll ordentligt i sladden när du tar ut den från eluttaget. Ta inte ut strömsladden medan produkten används. **Undermåliga eluttag kan orsaka elektriska stötar eller brand.**



Håll små tillbehör och förpackningsmaterial borta från små barn. Varning: kvävningssrisk. **Felaktig hantering av produkten kan orsaka skador som kan kräva akutvård.**



Håll vätskor borta från strömsladden och uttaget. Torka av med en torr trasa om strömsladden blir smutsig. **Undermåliga eluttag kan orsaka elektriska stötar eller brand.**



Låt inte produkten skadas av tunga föremål. **Undermåliga eluttag kan orsaka elektriska stötar eller brand.**



Om produkten avger underliga ljud, rök eller synlig rök skall du stänga av strömmen omedelbart, och koppla ur strömsladden. Om produkten tappas eller dess utsida skadas skall strömmen stängas av omedelbart och strömsladden dras ur. **Utsätt inte produkten för stötar. Detta kan orsaka skador på produkten eller brand.**



Installera produkten väl ventilerat, genom att placera den på ett visst avstånd från väggen. Om produkten installeras på en plats med mycket damm, fukt och temperaturväxlingar, eller om produkten används extremt kan det orsaka skador på skrivaren. Om den interna temperaturen ökar kan den orsaka brand. **Kontakta alltid återförsäljaren om du är osäker på placering av produkten.**



Installera produkten på en stadig yta så att den inte välter. Om produkten flyttas skall strömmen stängas av, och alla anslutna kablar, inklusive strömsladden, kopplas ur. **Dessa kan annars skada produkten.**



Demontera, reparera eller modifiera aldrig produkten själv, eftersom garantin då blir ogiltig. **Om produkten behöver repareras skall du kontakta den ursprungliga återförsäljaren.**



Låt inga främmande ämnen tränga in i produkten. Placera inte tunga föremål, vätskor eller metaller på produkten. **Detta kan orsaka skador på produkten eller brand.**



Om det uppstår problem med produkten ber vi dig kontakta den ursprungliga återförsäljaren, eller använda BIXOLON-webbplatsens sida för reparation av produkter (www.bixolon.com).



Spanish

Swedish