

BIXOLON

Network Connection Manual
Thermal POS Printer

Ver. 1.03

www.bixolon.com

Table of Contents

Copyright.....	3
1. Introduction.....	4
2. Precaution.....	5
2-1 WLAN.....	5
3. Specification.....	6
3-1 Network.....	6
3-2 Supported Model.....	7
3-2-1 Model List.....	7
3-2-2 On-Board Ethernet.....	8
3-2-3 Ethernet Interface Card (IFJ-E).....	9
3-2-4 Ethernet Interface Card (IFJ-EL).....	10
3-2-5 WLAN Interface Card (IFJ-WD).....	11
4. How to Connect.....	12
4-1 Connecting Printer.....	13
4-1-1 Connecting LAN.....	13
4-1-2 Connecting WLAN.....	13
4-2 Check Network Setting.....	14
4-2-1 Ethernet Interface Card(IFJ-E).....	14
4-2-2 On-Board Ethernet / Ethernet Interface Card(IFJ-EL) / WLAN.....	15
4-3 LAN Connection Setting (Windows 11).....	22
4-4 WLAN Connection Setting (Windows 11).....	26
4-5 WLAN Connection Configure (Android).....	34
4-6 WLAN Connection Configure (iOS).....	35
5. Network Test by using Windows Test Page.....	36
6. Factory Reset.....	43
6-1 Initializing Ethernet Interface Setting(IFJ-E).....	43
6-2 Initializing On-Board Ethernet / Ethernet Interface (IFJ-EL) / WLAN Setting.....	44
6-2-1 Standard model (Excluding SRP-Q300II).....	44
6-2-2 SRP-Q300II.....	47
6-2-3 Factory Reset Values.....	51
7. Troubleshooting.....	52

Copyright

© BIXOLON Co., Ltd. All rights reserved.

This user manual and all property of the product are protected under copyright law. It is strictly prohibited to copy, store, and transmit the whole or any part of the manual and any property of the product without the prior written approval of BIXOLON Co., Ltd.

The information contained herein is designed only for use with this BIXOLON product. BIXOLON is not responsible for any direct or indirect damages, arising from or related to use of this information.

- The BIXOLON logo is the registered trademark of BIXOLON Co., Ltd.
- All other brand or product names are trademarks of their respective companies or organizations.

BIXOLON Co., Ltd. maintains ongoing efforts to enhance and upgrade the functions and quality of all our products.

In the following, product specifications and/or user manual content may be changed without prior notice.

Caution

Some semiconductor devices are easily damaged by static electricity. You should turn the printer "OFF", before you connect or remove the cables on the rear side, in order to guard the printer against the static electricity. If the printer is damaged by the static electricity, you should turn the printer "OFF".

1. Introduction

This Network manual provides information on the connection of network with the Industrial Label printer.

2. Precaution

2-1 WLAN

- 1) The printer has to be within 100m(Outdoor) from AP(Access point) to connect WLAN. Although 35m is able to communicate in door, WLAN could be affected by environment to be shorten.
- 2) The maximum separating distance may be shortened if transmission obstacles, such as cement walls, are present.
- 3) If a device (such as a microwave oven, wireless LAN, etc.) that uses the same frequency is present, transmission may be interrupted. Separate the printer and Bluetooth-enabled device from such interrupting devices by a distance of at least 5m.

3. Specification

3-1 Network

Categories	Feature	Implementation	
LAN	Interface	10/100 Base-T All in one(Auto detection)	
	Protocol	DHCP Client, HTTP, ARP, ICMP, IPv4, TCP, UDP	
WLAN	Operation Mode	Infrastructure, Soft AP, Ad-hoc, Wi-Fi Direct	
	Wireless Standard	IEEE 802.11a/b/g/n	
	Range	Up to 100m free space (Outdoor)	
	Security		WEP64/128
			WPA1/2 - PSK
		WPA1/2 - Enterprise (EAP-TLS, EAP-TTLS, PEAP, LEAP, EAP-FAST)	
Management		WLAN Configuration tool, HTTP, Smart connection APP	

3-2 Supported Model

- Check the back of the printer to identify the type of Ethernet interface that the printer provides.

3-2-1 Model List

Model	LAN			WLAN (Option)	
	On-Board	IFJ-E	IFJ-EL	Built-in	IFJ-WD
SRP-380/2	-	O	O	-	O
SRP-380/2plus	O	-	-	-	O
SRP-F310/2/3II	O	-	-	-	O
SRP-350/2plusIII	O	-	-	-	O
SRP-350/2plusV	O	-	-	-	O
SRP-350/2III	-	O	-	-	-
SRP-350/2V	-	-	O	-	-
SRP-S200	O	-	-	-	-
SRP-S300	-	O	O	-	O
SRP-S320	O	-	-	-	O
SRP-S3000	O	-	-	O	-
SRP-Q200	O	-	-	O	-
SRP-Q300/2	O	-	-	O	-
SRP-Q300II	O	-	-	O	-
SRP-QE300/2	O	-	-	-	-
SRP-330/2II	O	-	-	-	-
SRP-330/2III	O	-	-	-	-
SRP-E300/2	O	-	-	-	-
SRP-B300	O	-	-	-	-
BK3-31	O	-	-	-	-

3-2-2 On-Board Ethernet

The image below is provided as an example for reference only.

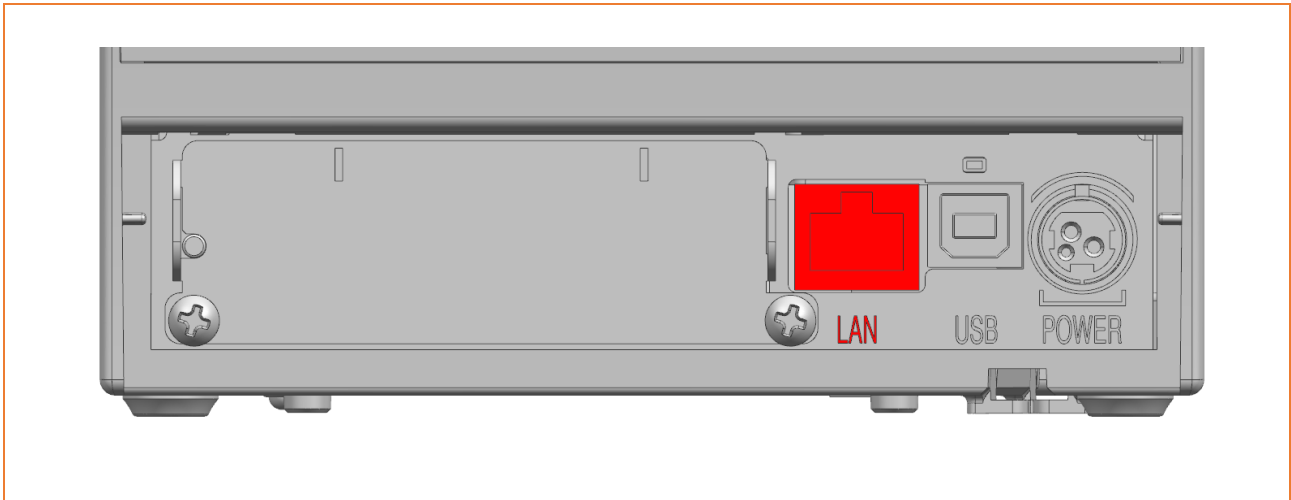

3-2-3 Ethernet Interface Card (IFJ-E)

The image below is provided as an example for reference only.

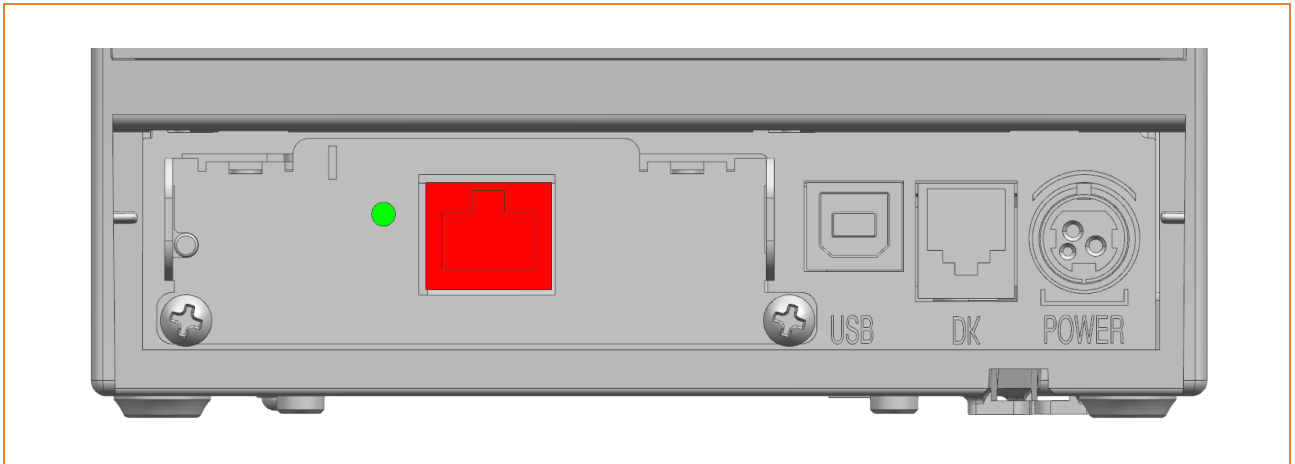

3-2-4 Ethernet Interface Card (IFJ-EL)

The image below is provided as an example for reference only.

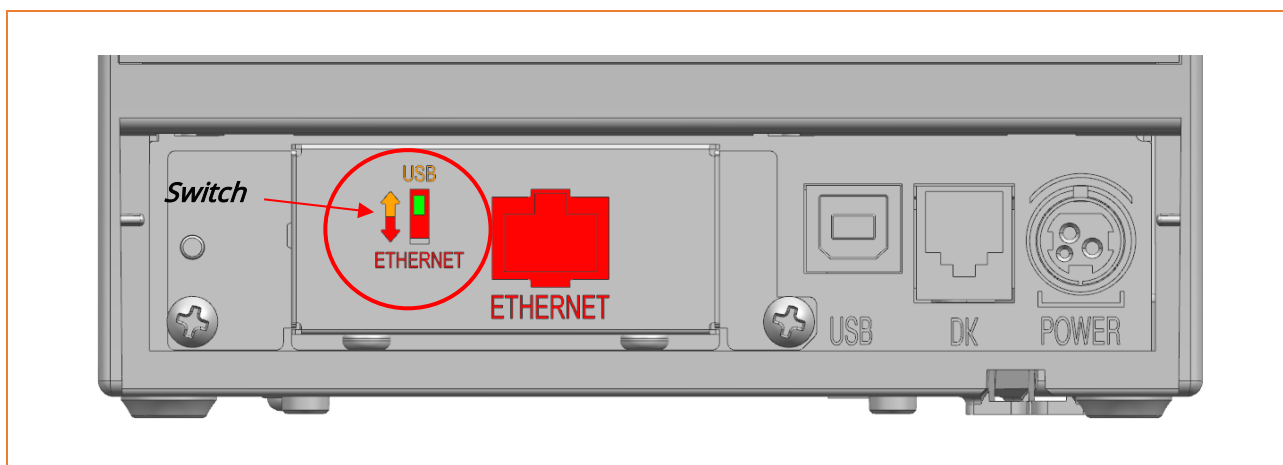

- Make sure that the printer is powered off before manipulating the switch.
- On-board Ethernet cannot be used when the IFJ-EL is installed.
- If the IFJ-EL is switched to Ethernet,
 - On-board USB is disabled.
- If the IFJ-EL is switched to USB,
 - On-board USB is enabled.
 - Ethernet on the IFJ-EL is not available.

Network Connection Manual

3-2-5 WLAN Interface Card (IFJ-WD)

The image below is provided as an example for reference only.

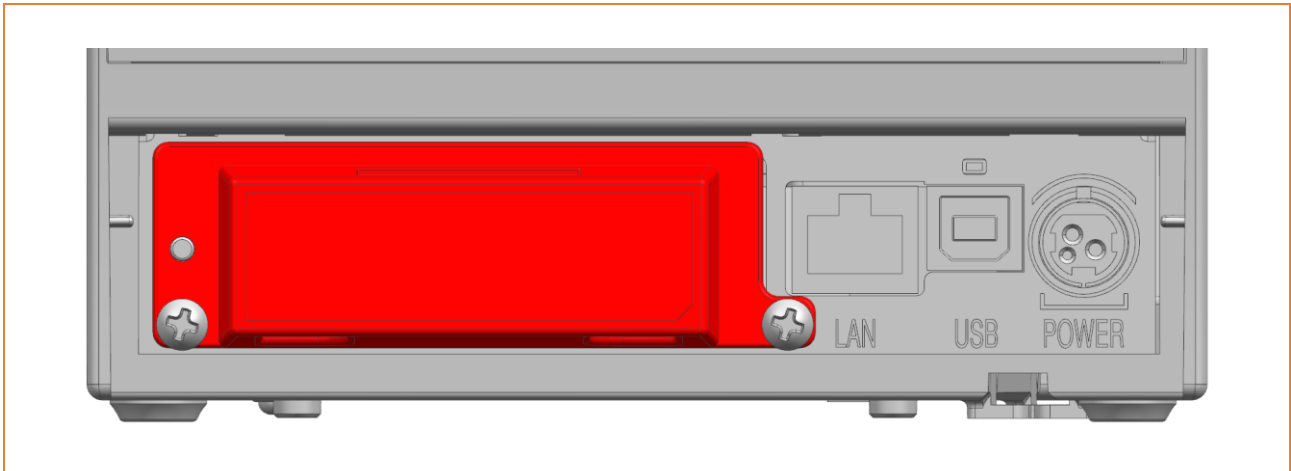

4. How to Connect

Network can be configured through the printer's LCD Display, USB, Network interface.

When changing the printer network, it is essential to ensure that the network settings of the host (e.g., PC, PDA) and the printer are properly configured for communication.

4-1 Connecting Printer

4-1-1 Connecting LAN

Connect Ethernet cable to Printer and network device.
Use the "Net Configuration Tool" to adjust the settings.

4-1-2 Connecting WLAN

Connect USB cable to Printer, PC device.
Use the "Net Configuration Tool" to adjust the settings.

Set the printer to Infrastructure mode to configure a network with an AP (Access Point).

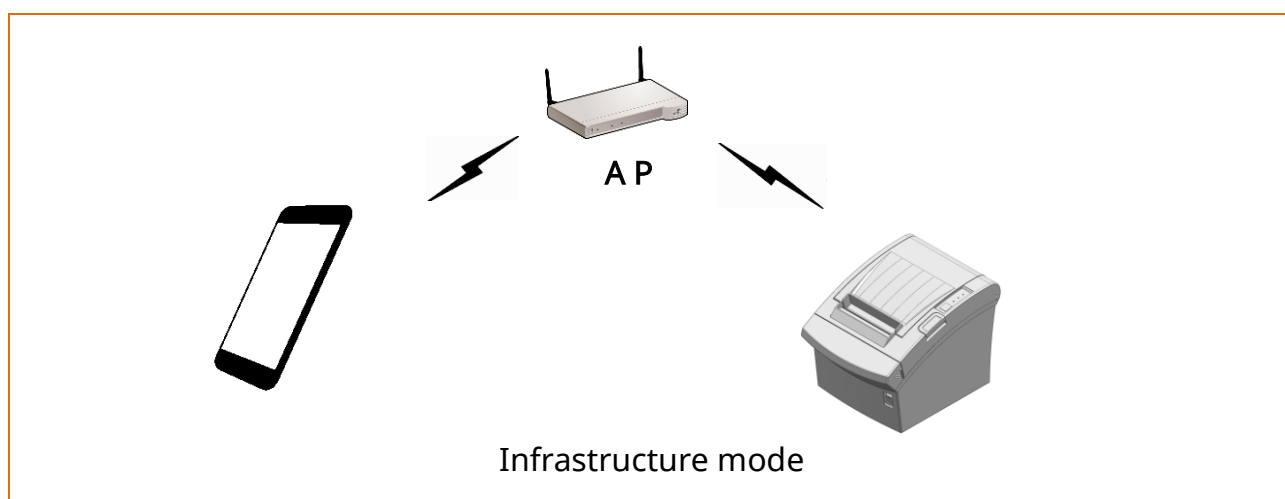

Set the printer to Soft AP mode to configure a network with a direct connection between the wireless host device and the printer.

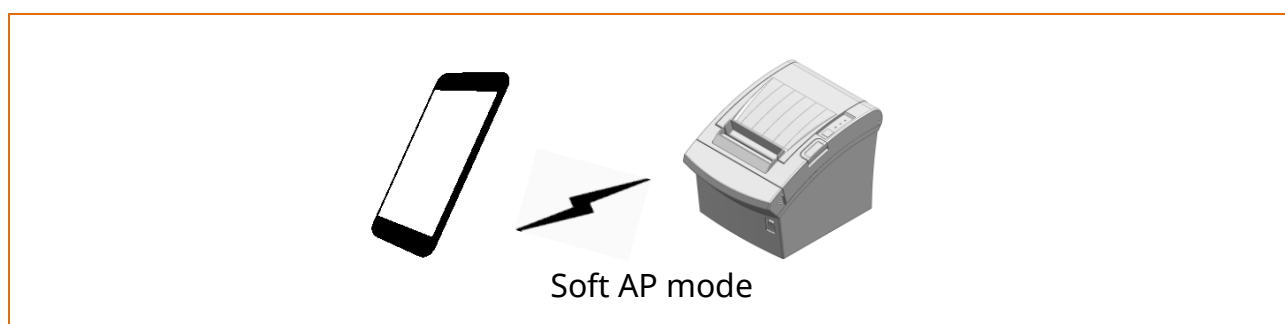

* Soft AP mode is only supported on IFJ-WD.

4-2 Check Network Setting

4-2-1 Ethernet Interface Card(IFJ-E)

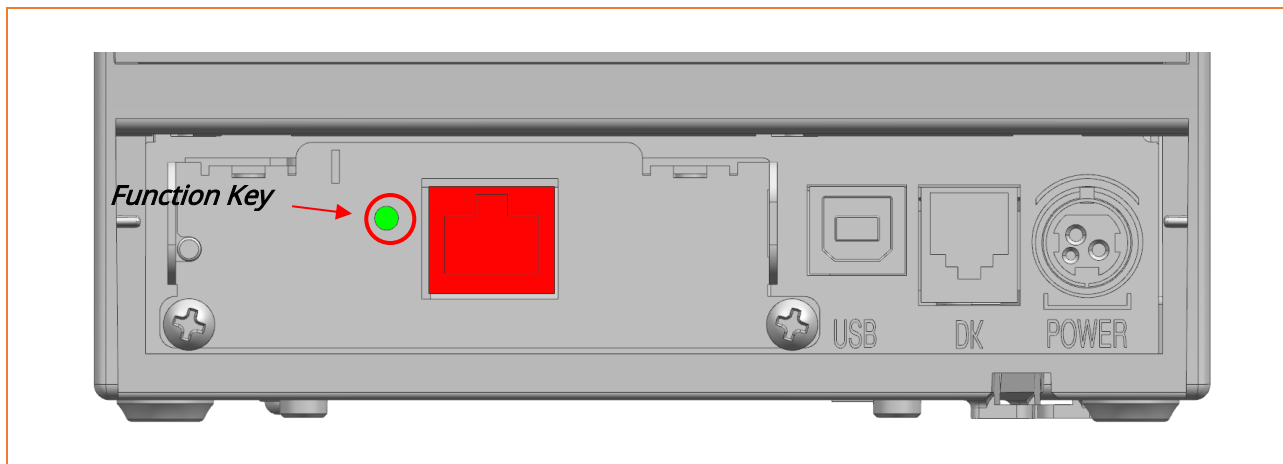

When the printer is booted, press the "Function Key" button to output the network setting value.



In DHCP mode, the network setting values are not output when no IP address is assigned. (To retrieve the network setting values, press the "Function Key" for about 10 seconds after powering on.)

```
LAN SETTING
MAC ADDRESS : 00:15:94:C2:6B:A8
IP ADDRESS  : 192.168.0.48
SUBNET MASK : 255.255.255.0
GATEWAY     : 192.168.0.1
PORT        : 9100
```

<LAN Information Printing>

4-2-2 On-Board Ethernet / Ethernet Interface Card(IFJ-EL) / WLAN

4-2-2-1 Standard model (Excluding SRP-Q300II)

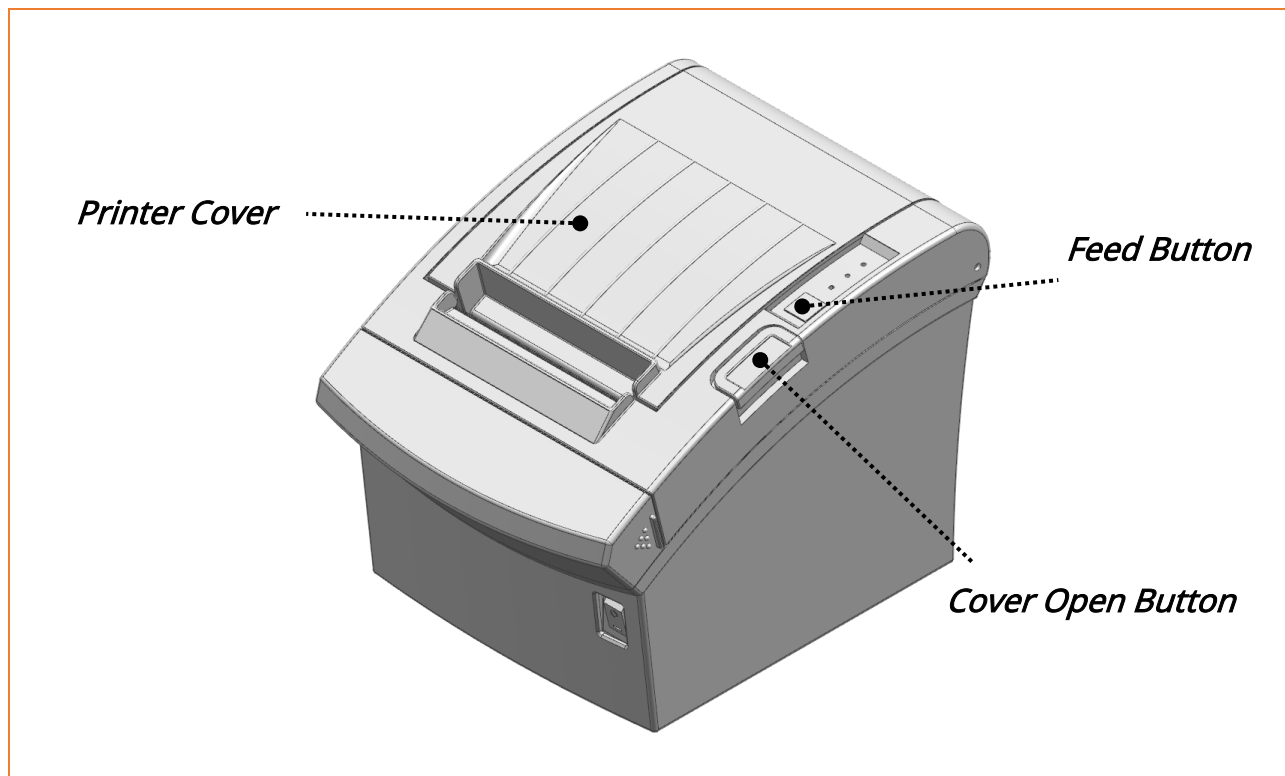

1) Open the printer cover after the printer has fully booted up.

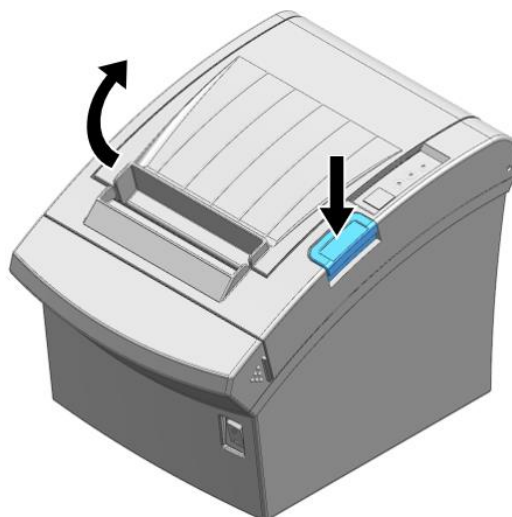

2) Press and hold the Feed button for 5 seconds.

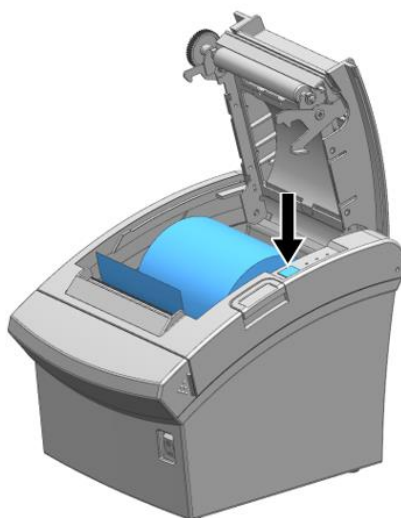

3) When you close the printer cover, the internal buzzer will beep 5 times and the printer will enter the interface setting verification mode. You will then see the following message printed out.

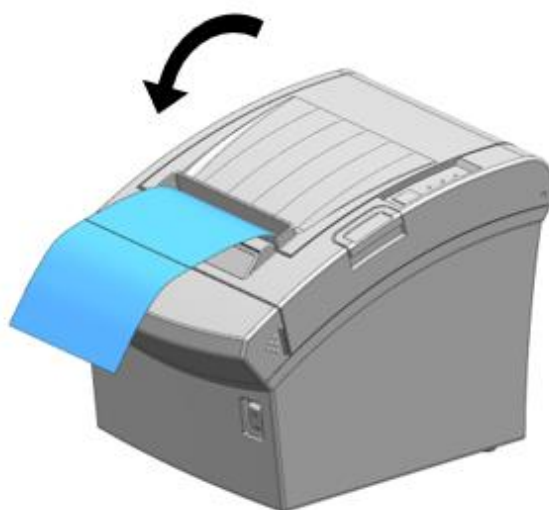

- Error/Paper LED toggles when WLAN boots up.
- The number of interface setting information may be different for each interface type of the product.

Checking Interface Setting

0: Exit
1: LAN Information Print
2: LAN Factory Reset and Reboot Printer
3: WLAN Information Print
4: WLAN Factory Reset and Reboot Printer
5 or more: None

Select Modes by Feed button control
as below.

Step 1. Short-press as many times
as the mode number to choose

Step 2. Long-press over 1 second.

*e.g. To choose Mode 2, press Feed
button 3 times(short-short-long)

If the above message is printed, select Mode 1 / 3, and you will see the following network data.

- To select Mode 1, press the Feed button once quickly/ once long.
- To select Mode 3, press the Feed button three times quickly/ once long.

Network Connection Manual

LAN SETTING

MAC ADDRESS : 00:15:94:C2:6B:A8
IP ADDRESS : 192.168.0.48
SUBNET MASK : 255.255.255.0
GATEWAY : 192.168.0.1
PORT : 9100
INACTIVITY : 0
DHCP MODE : ENABLE

< LAN Information Printing >

WLAN SETTING

WLAN F/W VERSION : 02.00(3930)
SYSTEM NAME : SRP-350plusV
NETWORK MODE : SOFT AP
FREQUENCY : (Priority) 2.4GHz/5GHz
AUTHENTICATION : OPEN
ENCRYPTION : NONE
ESSID : PRINTER_B03223
DHCP : ENABLED
IP ADDRESS : 192.168.1.1
SUBNET MASK : 255.255.255.0
GATEWAY : 192.168.1.2
PORT : 9100
WLAN MACADDRESS :



0 0 1 5 9 4 B 0 3 2 2 3

< WLAN Information Printing >

4-2-2-2 SRP-Q300II

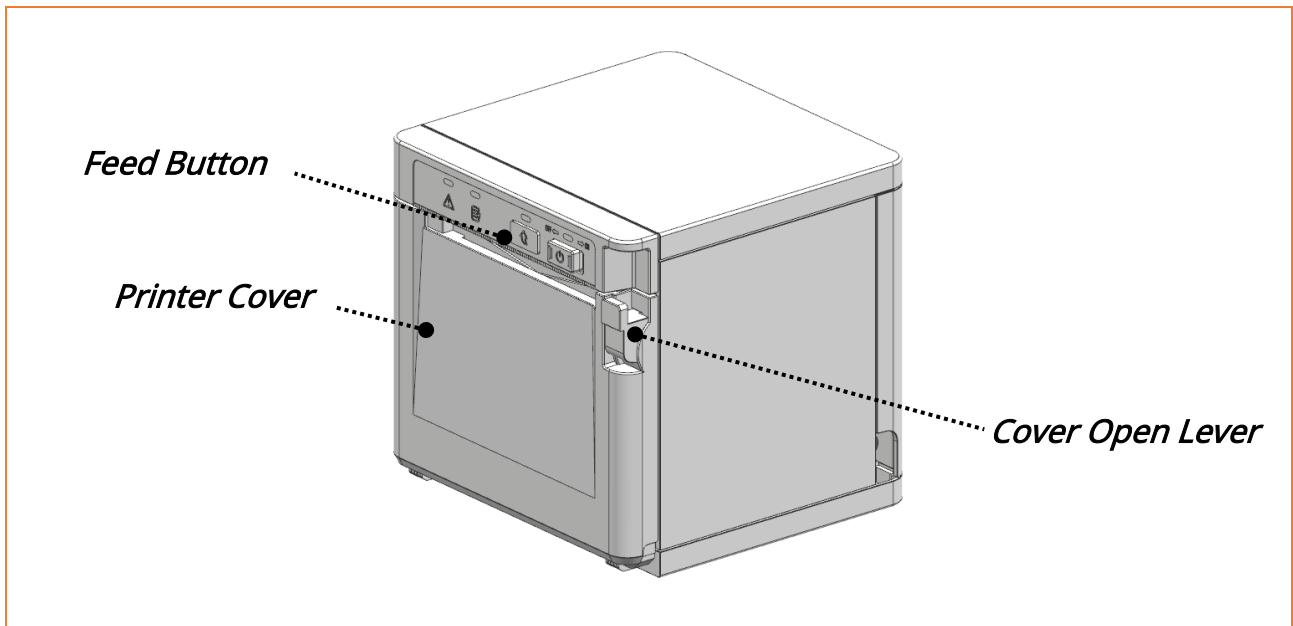

1) Open the printer cover after the printer has fully booted up.

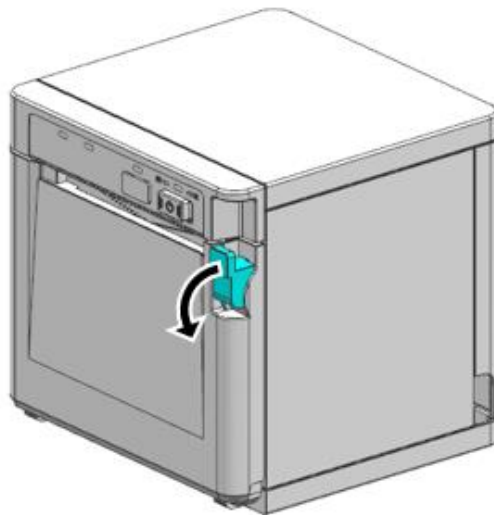

2) Press the Feed button.

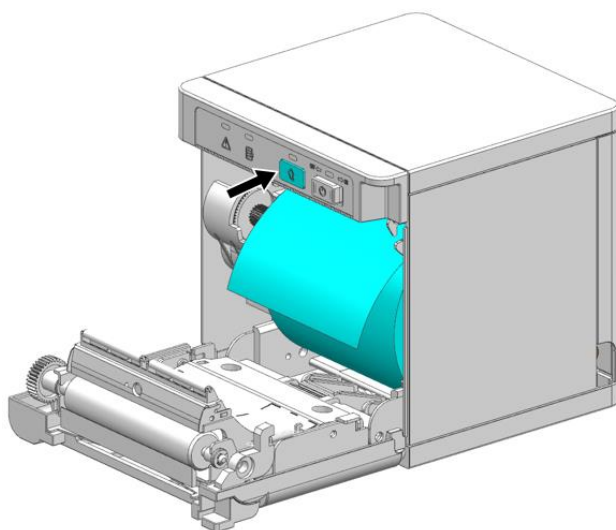

3) When you close the printer cover, the printer will enter the interface setting verification mode. For setting information, refer to the "Ethernet configuration" and "WLAN configuration" sections in SELF TEST INFORMATION.

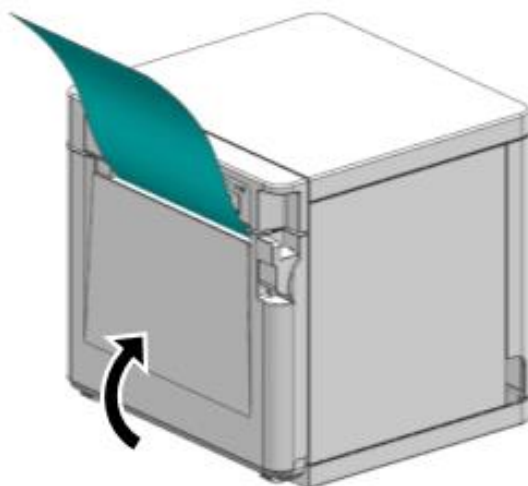

Network Connection Manual

SRP-Q300II SELF TEST INFORMATION

Firmware Version V0x.xx STB xxxxxx

Configuration

...

...

Ethernet configuration

...

...

WLAN configuration

...

...

SELECT MODES BY PRESSING FEED BUTTON

Exit SELF-TEST : Less than 1 second

Mode Selection : 1 second or more

4-3 LAN Connection Setting (Windows 11)

1) Search the "Settings" and then Click the "Settings"

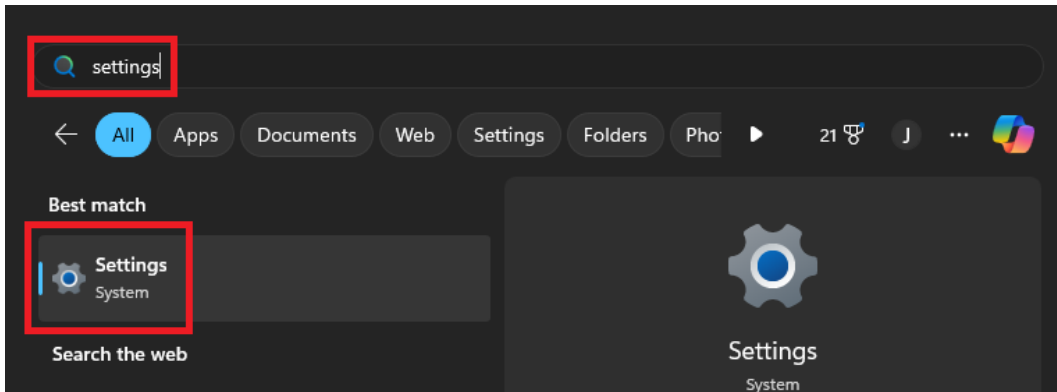

2) Click the "Network & Internet" >> "Ethernet"

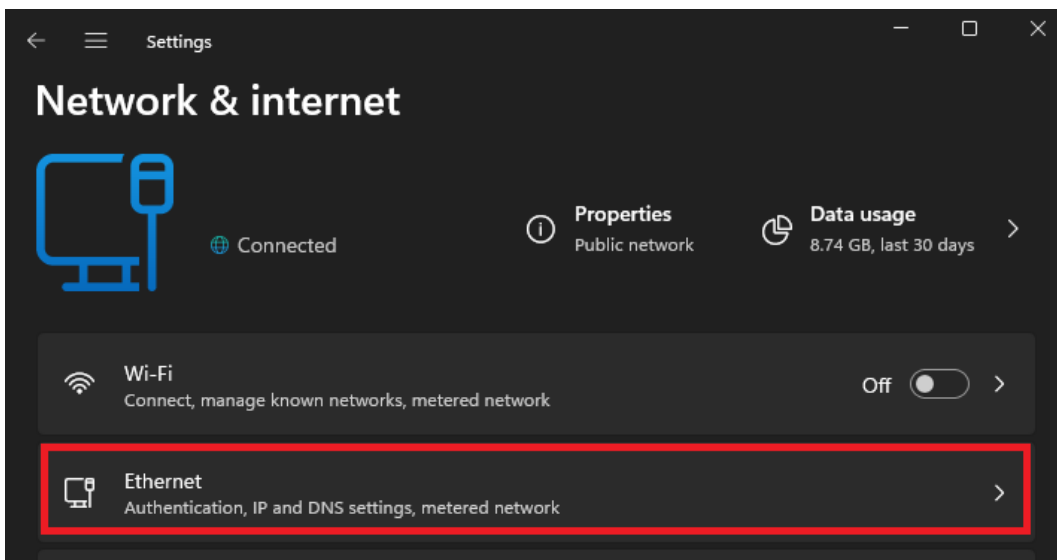

3) Click the "IP assignment" >> "Edit"

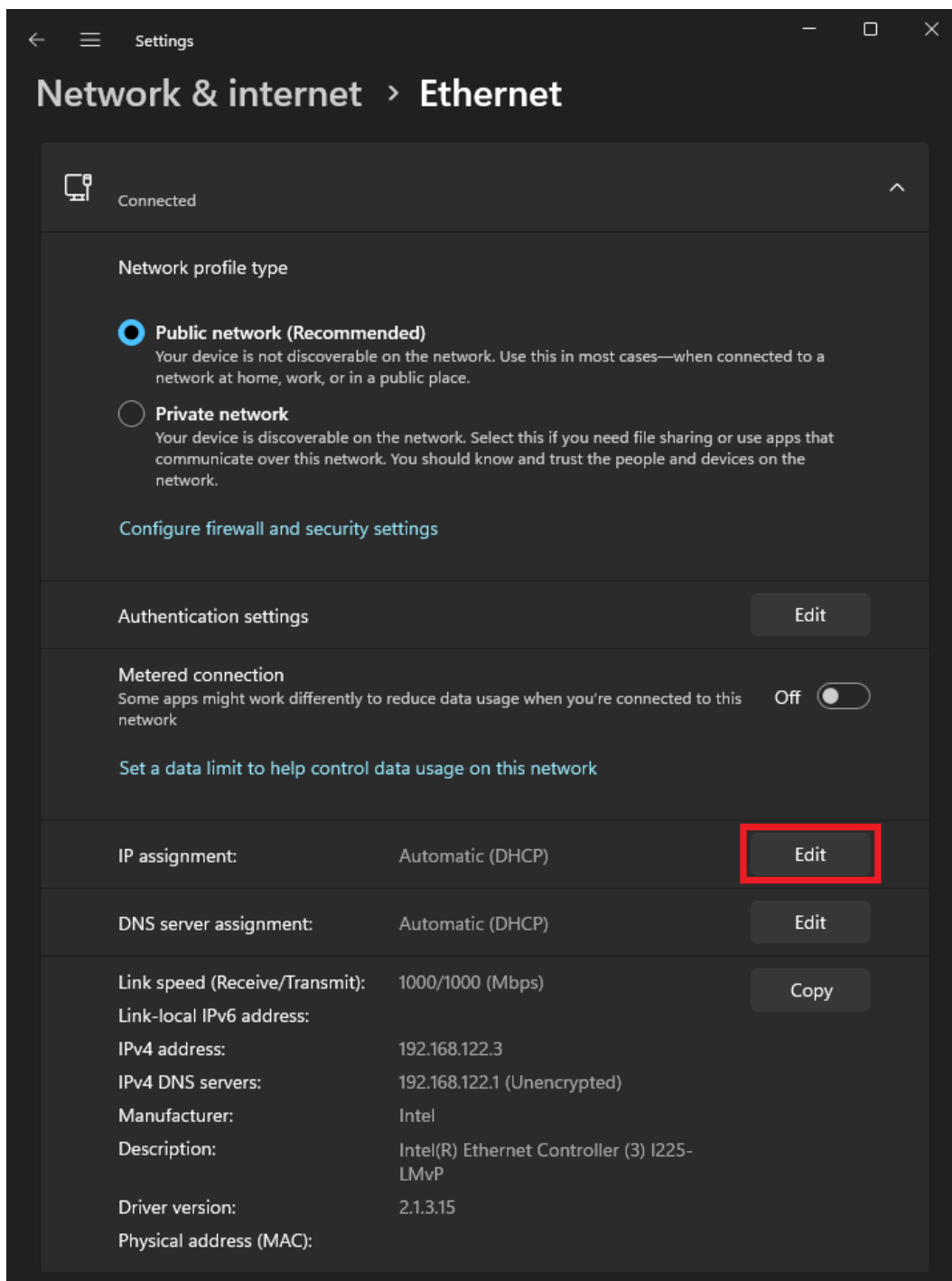

Network Connection Manual

4-1) If the printer and the host device are designed to receive an IP address from a DHCP server, select "Automatic (DHCP)" and then click "Save."



The screenshot shows a dark-themed dialog box titled "Edit IP settings". At the top, there is a dropdown menu with "Automatic (DHCP)" selected. Below the dropdown, there are two buttons: "Save" and "Cancel". The "Save" button is highlighted with a red border.

4-2) If the printer and the host device are designed to use a static IP address, select "Manual" and enable "IPv4." Enter the settings for "IP address," "Subnet mask," "Gateway," and "Preferred DNS," and then click "Save."

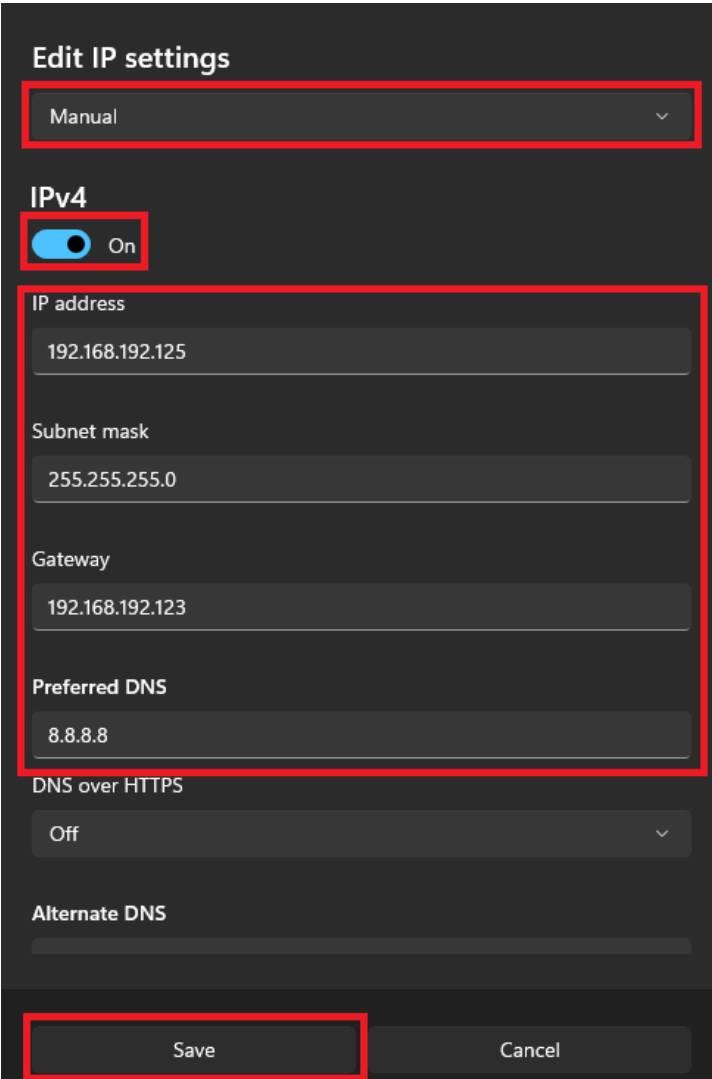

The screenshot shows a dark-themed dialog box titled "Edit IP settings". At the top, there is a dropdown menu with "Manual" selected. Below the dropdown, there is a section for "IPv4" with a toggle switch set to "On". Below the "IPv4" section, there are four text input fields: "IP address" (192.168.192.125), "Subnet mask" (255.255.255.0), "Gateway" (192.168.192.123), and "Preferred DNS" (8.8.8.8). Below these fields, there is a section for "DNS over HTTPS" with a dropdown menu set to "Off". At the bottom, there is a section for "Alternate DNS" with an empty text input field. The "Save" button is highlighted with a red border.



- When setting “Edit IP settings” to “Manual,” make sure that you assign a correct IP address to avoid IP address conflicts on the network.
- Incorrect “IP address” and “Subnet mask” settings may disrupt communication with the printer.

4-4 WLAN Connection Setting (Windows 11)

1) Search the "Settings" and then Click the "Settings"

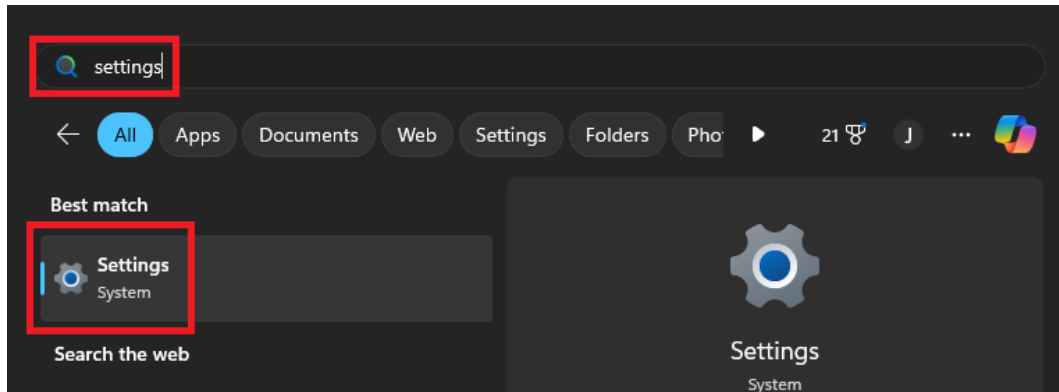

2) Click the "Network & Internet" >> "Wi-Fi"

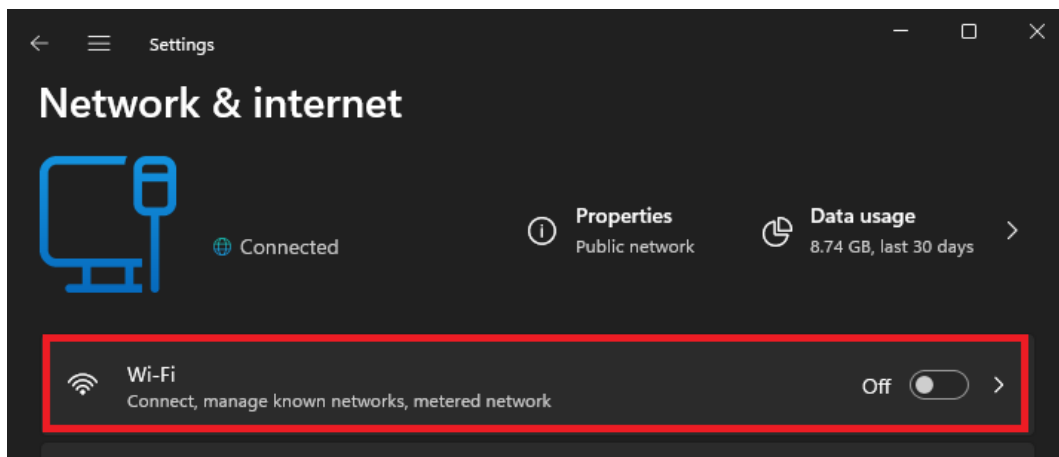

3) Click the "Wi-Fi" turn on.

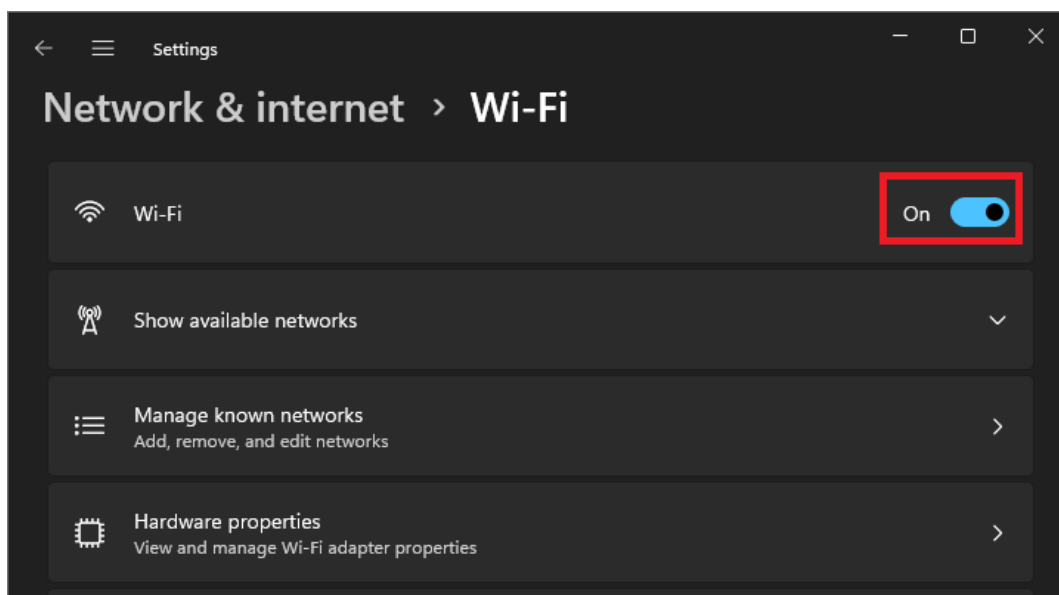

4) Click the "Hardware properties"

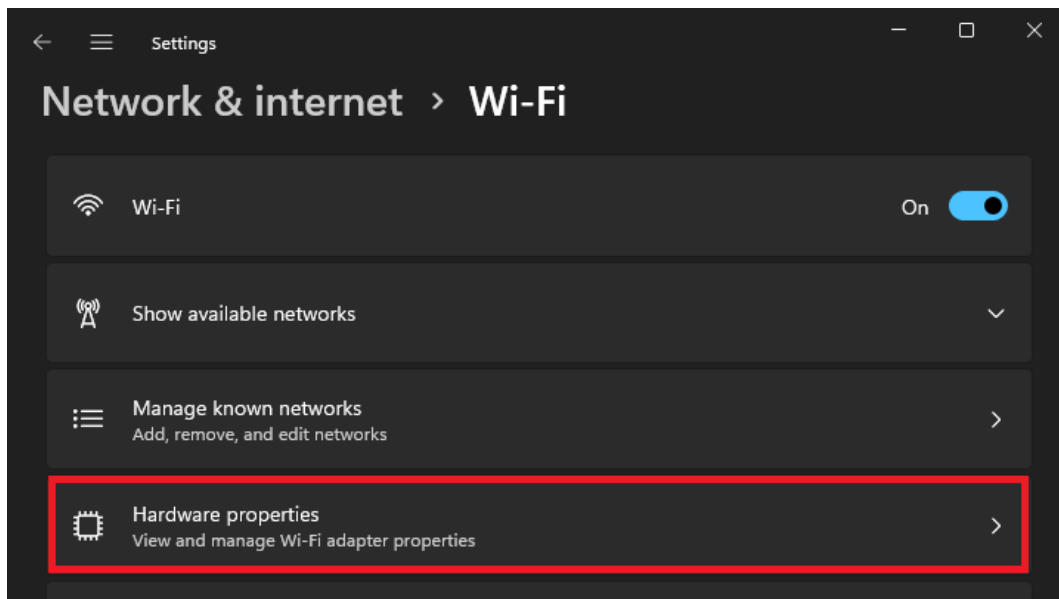

5) Click the "IP assignment" >> "Edit"

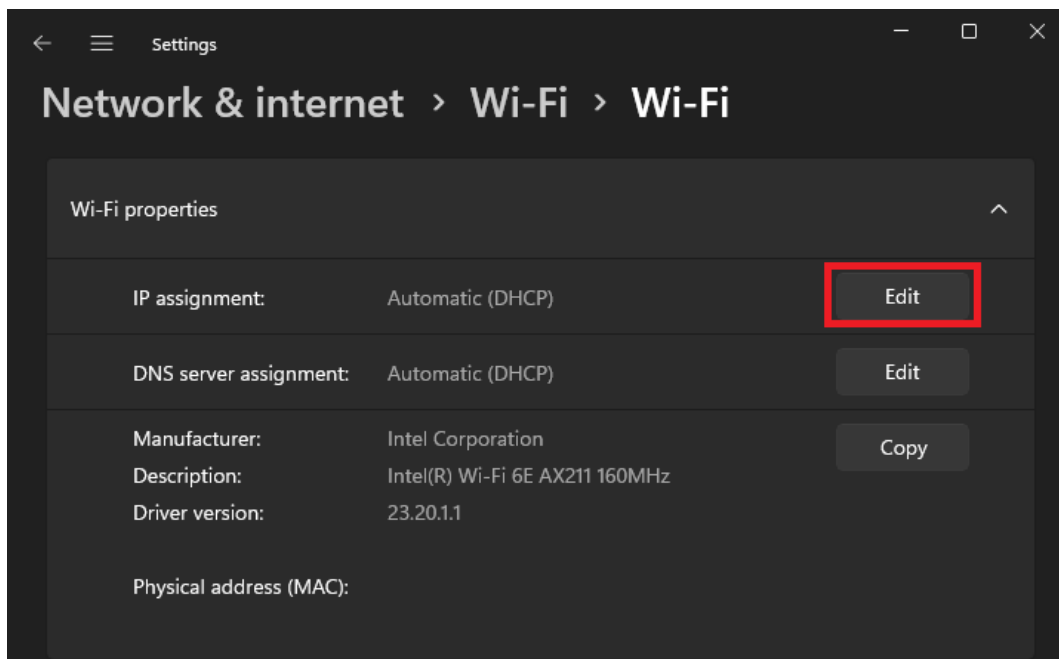

Network Connection Manual

- 6-1) If the printer and the host device are designed to receive an IP address from a DHCP server, select "Automatic (DHCP)" and then click "Save."

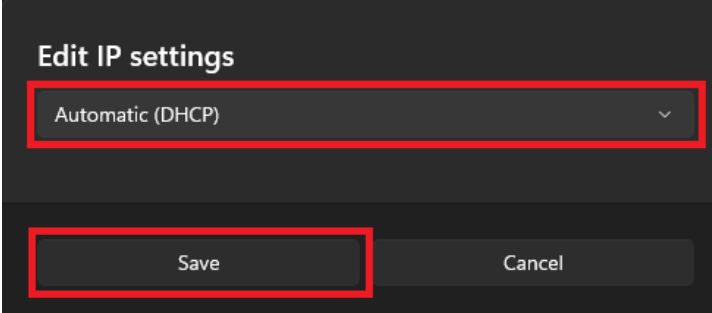

The screenshot shows a dark-themed dialog box titled "Edit IP settings". At the top, there is a dropdown menu with "Automatic (DHCP)" selected. Below the dropdown, there are two buttons: "Save" and "Cancel". The "Save" button is highlighted with a red rectangular box.

- 6-2) If the printer and the host device are designed to use a static IP address, select "Manual" and enable "IPv4." Enter the settings for "IP address," "Subnet mask," "Gateway," and "Preferred DNS," and then click "Save."

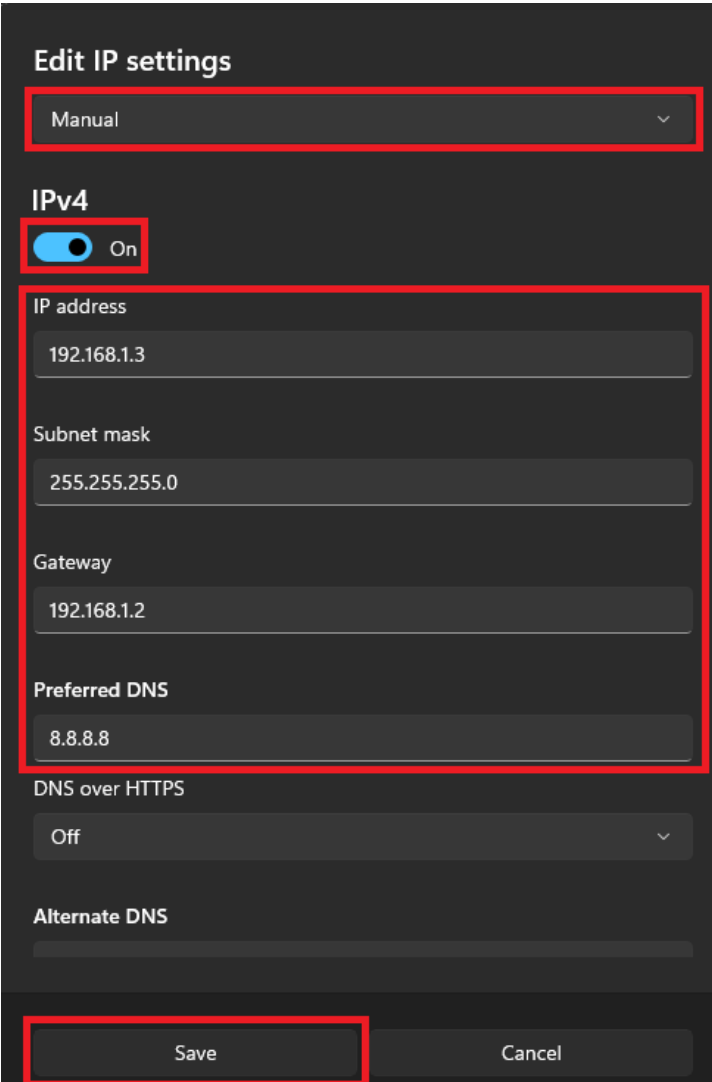

The screenshot shows a dark-themed dialog box titled "Edit IP settings". At the top, there is a dropdown menu with "Manual" selected. Below the dropdown, there is a section for "IPv4" with a toggle switch set to "On". Underneath, there are four text input fields: "IP address" (192.168.1.3), "Subnet mask" (255.255.255.0), "Gateway" (192.168.1.2), and "Preferred DNS" (8.8.8.8). Below these fields, there is a "DNS over HTTPS" dropdown menu set to "Off". At the bottom, there is an "Alternate DNS" text input field. The "Save" button is highlighted with a red rectangular box.



- When setting “Edit IP settings” to “Manual,” make sure that you assign a correct IP address to avoid IP address conflicts on the network.
- Incorrect “IP address” and “Subnet mask” settings may disrupt communication with the printer.

7) Click the "Manage known networks"

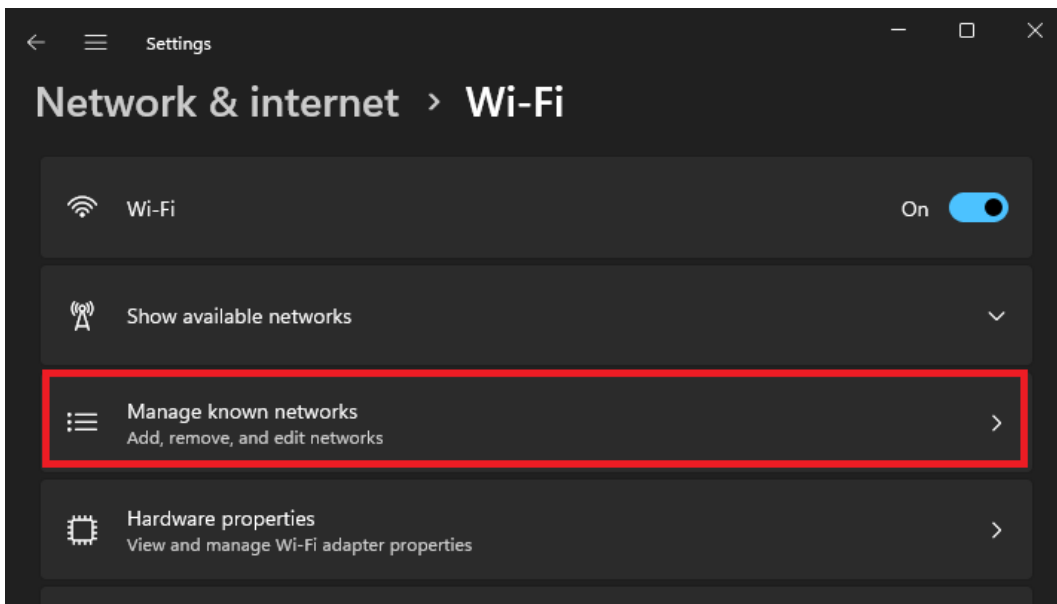

8) Click the "Add a new network" >> "Add network"

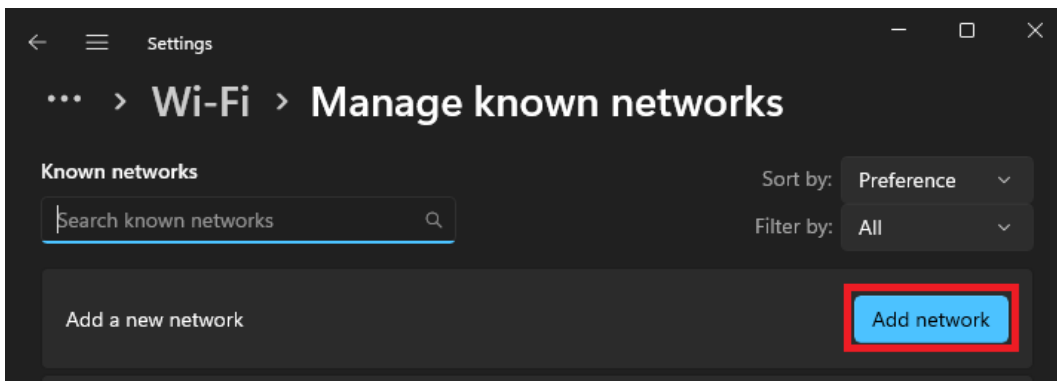

Network Connection Manual

9-1) If the printer is in Soft-AP mode, check the printer's Wi-Fi information and enter the settings accordingly.

The screenshot shows a dark-themed dialog box titled "Add a new network". It contains the following fields and options:

- Network name:** A text input field containing "PRINTER_E09000".
- Security type:** A dropdown menu set to "Open".
- Connect automatically:** A checked checkbox.
- Connect even if this network is not broadcasting:** A checked checkbox.
- Buttons:** "Save" and "Cancel" buttons at the bottom.

9-2) If the printer is in Infrastructure mode, check the Wi-Fi AP information to which the printer is connected and enter the settings accordingly.

The screenshot shows a dark-themed dialog box titled "Add a new network". It contains the following fields and options:

- Network name:** A text input field containing "BIXOLON".
- Security type:** A dropdown menu set to "WPA2-Personal AES".
- Security key:** A text input field containing eight dots (••••••••).
- Connect automatically:** A checked checkbox.
- Connect even if this network is not broadcasting:** A checked checkbox.
- Buttons:** "Save" and "Cancel" buttons at the bottom.



Depending on the network connection status of your host PC, you may not be able to connect to the Wi-Fi AP. In such cases, select "Show available networks" to manually select a Wi-Fi AP.

Network Connection Manual

10) Click the “Show available networks”

Select a Wi-Fi AP from the list, and then click “Connect.”

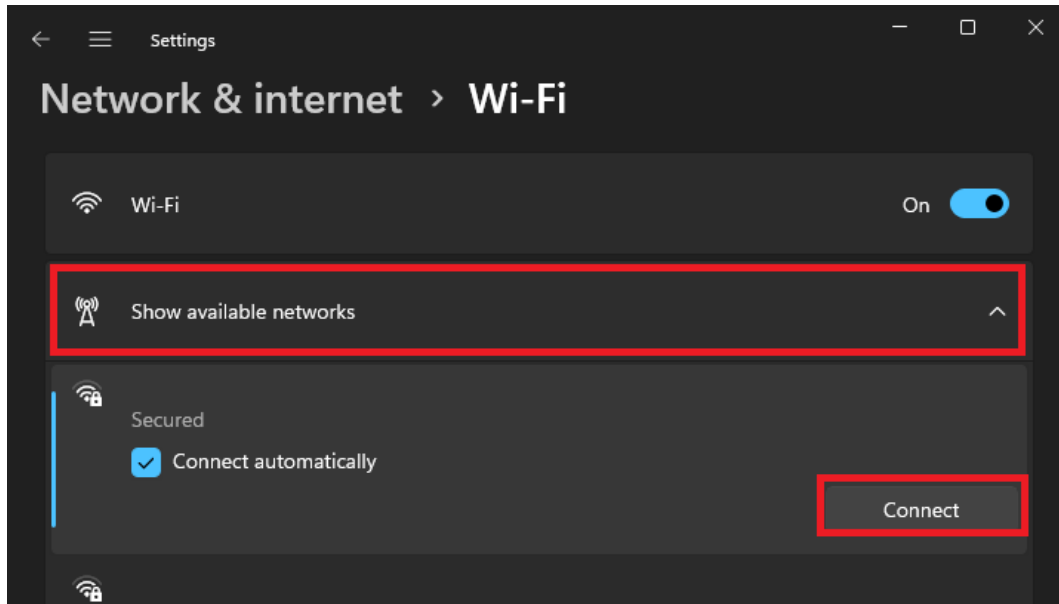

4-5 WLAN Connection Configure (Android)

1) Select "Wi-Fi".

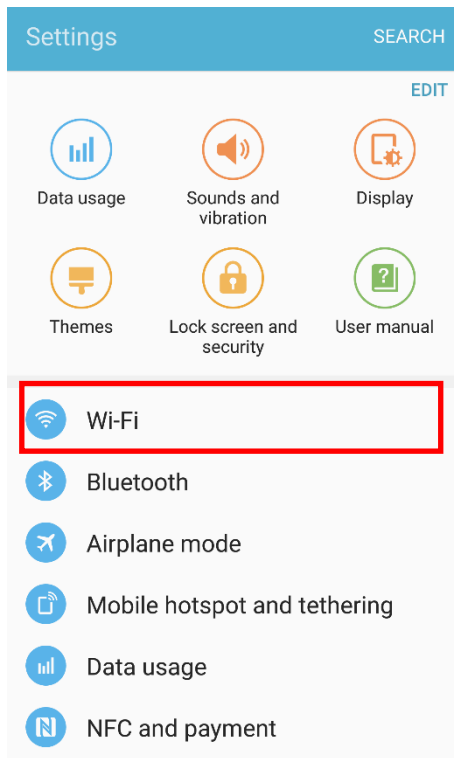

2) Select the printer or Wi-Fi AP to connect.

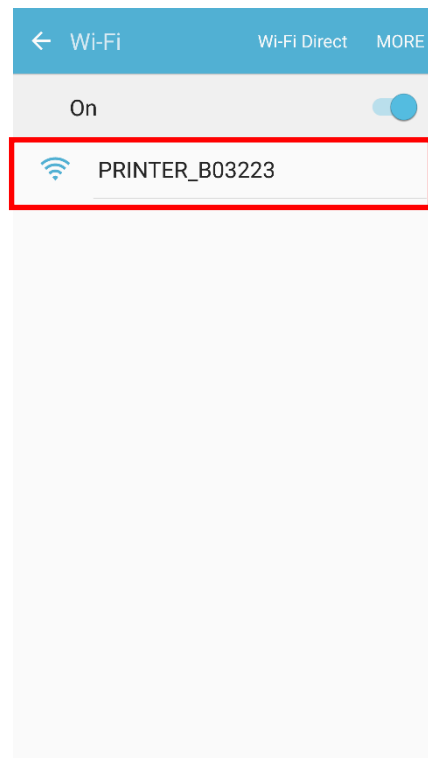

3) Select "CONNECT".

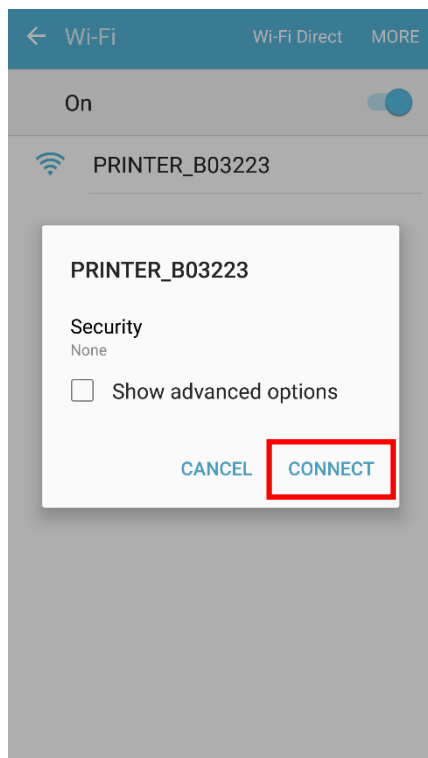

4) Wi-Fi communication is available.

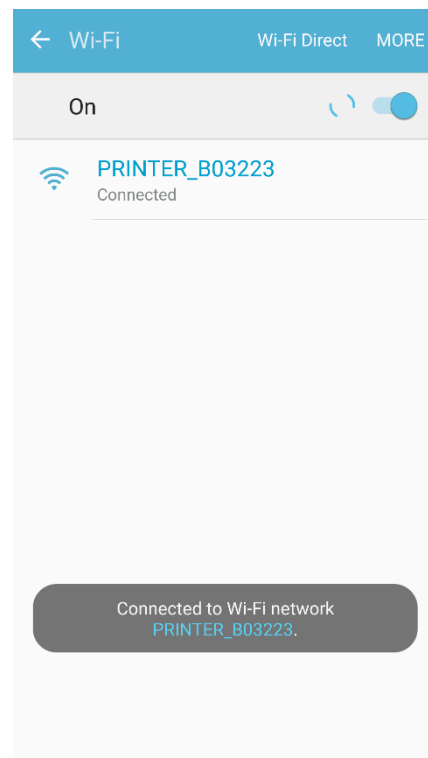

4-6 WLAN Connection Configure (iOS)

1) Select "Wi-Fi".

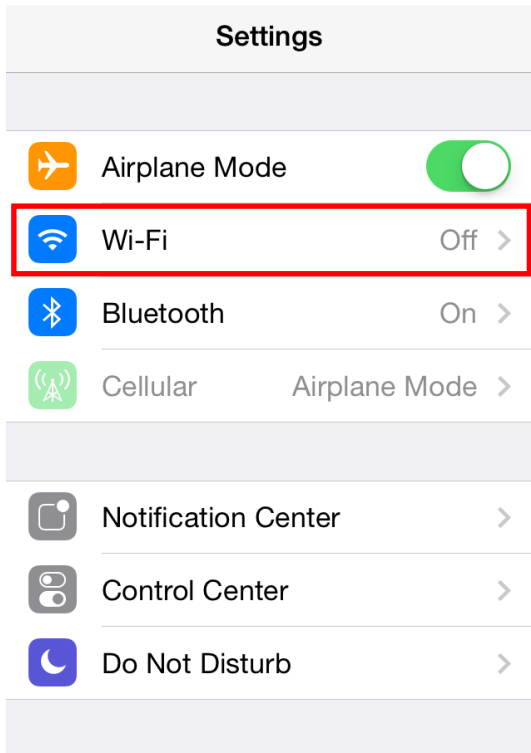

2) Wi-Fi ON and Select the printer or Wi-Fi AP to connect.

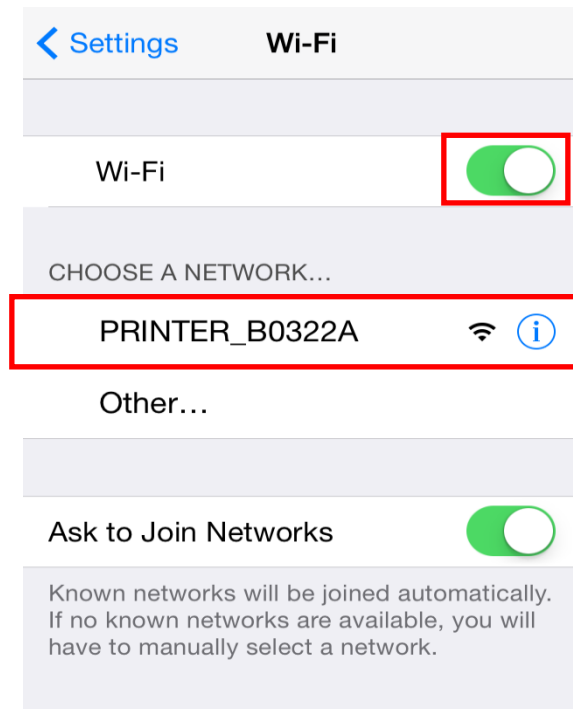

3) Wi-Fi communication is available.

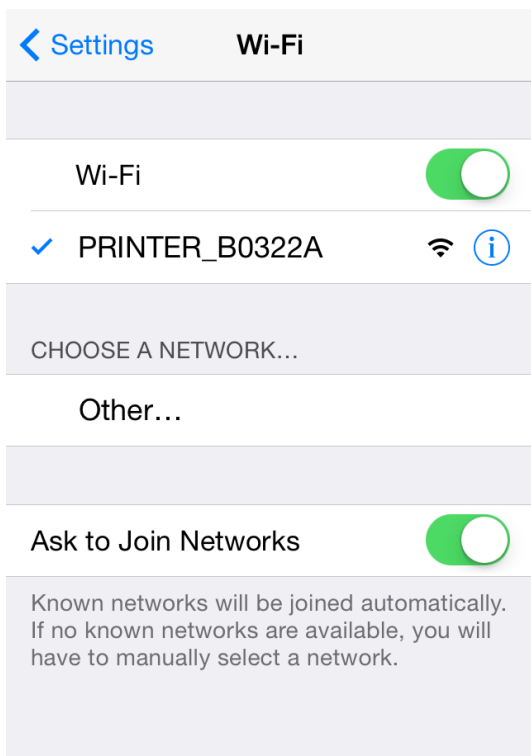

5. Network Test by using Windows Test Page

You can use the Windows printer driver as shown below when there is no test program.



You can download the latest version of Windows driver from our home page. (www.bixolon.com)

1) Double-click the Windows Driver installation file.

2) Click "Install".

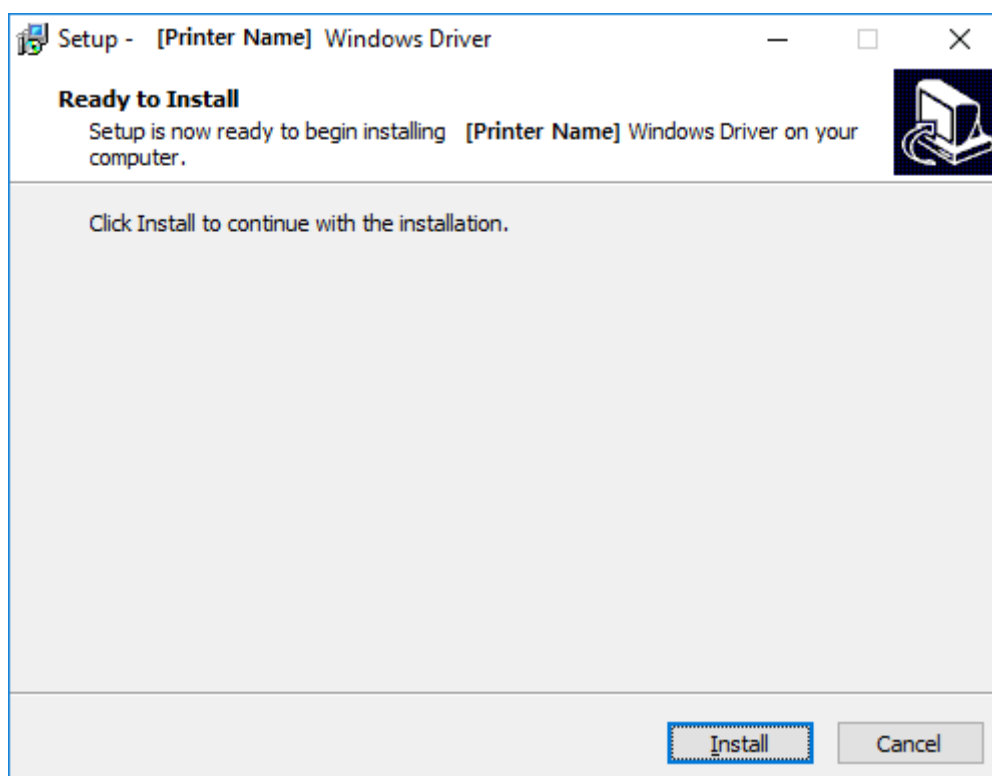

3) Select "Installation" and click "Next".

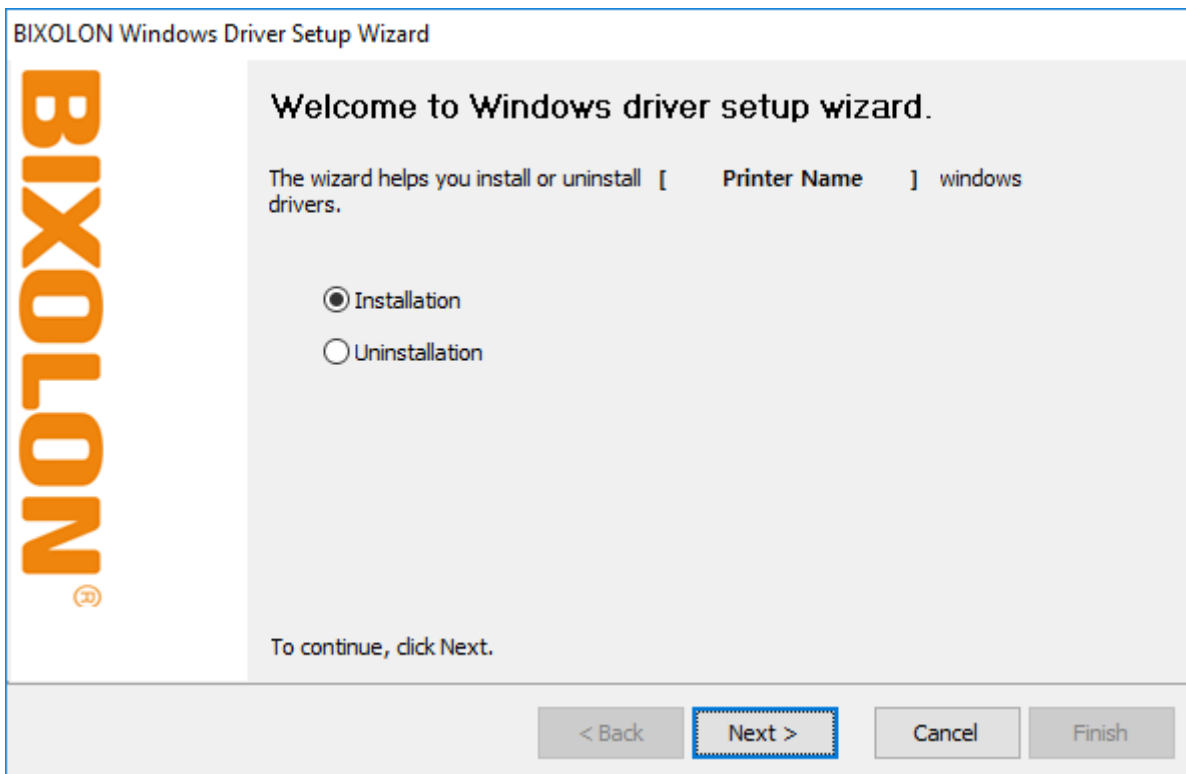

4) Select "Model Name" and click "Next".

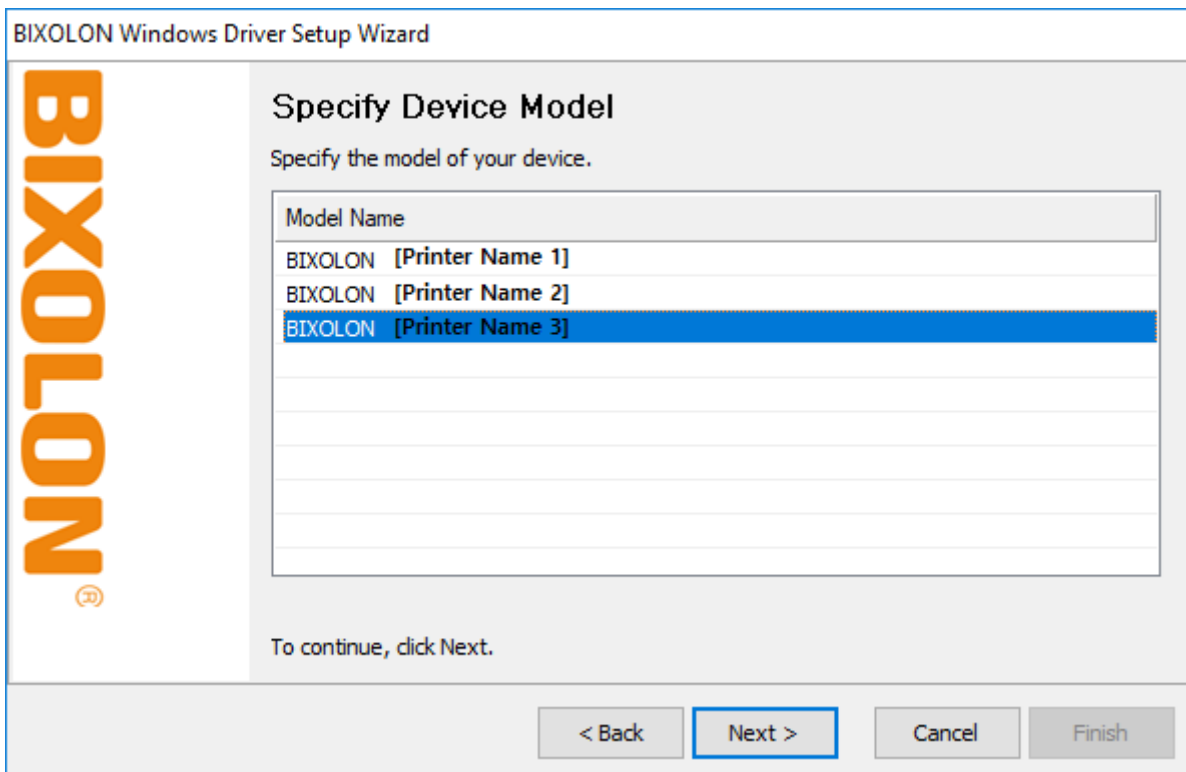

5) Select "Network" and click "Add TCP/IP Port".

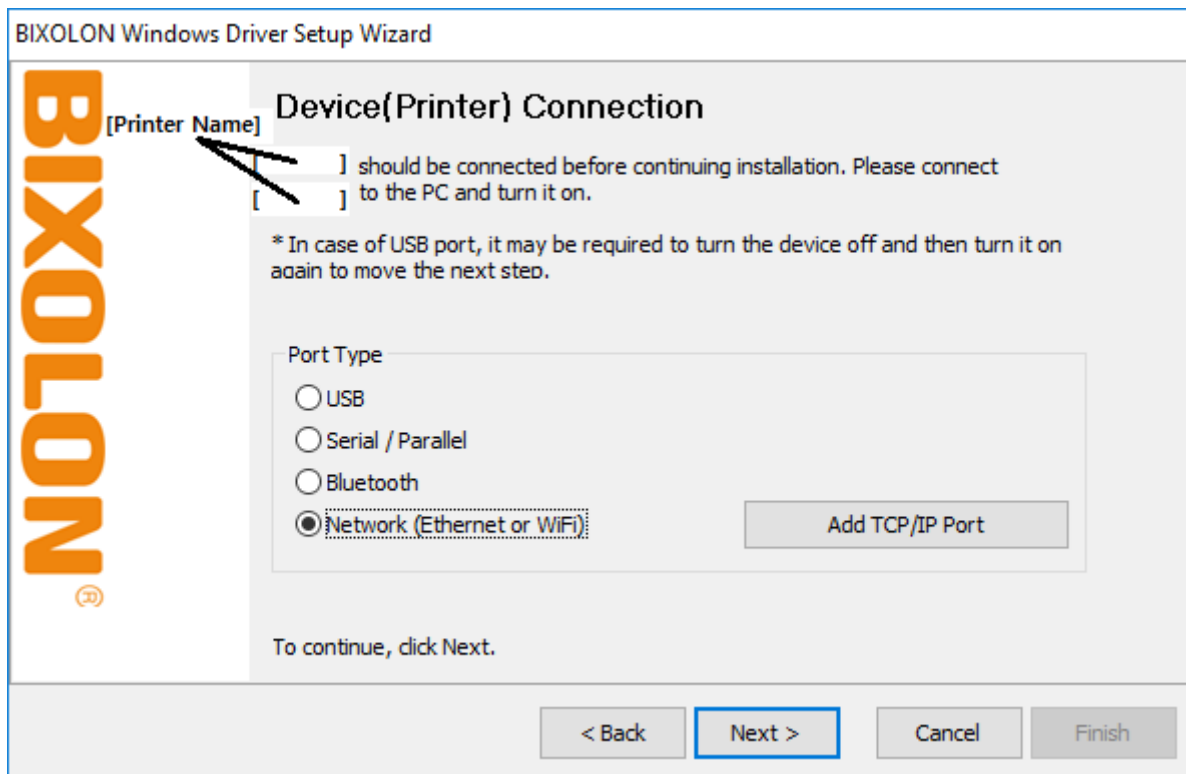

6) Enter the IP address and port number, and then click "OK".

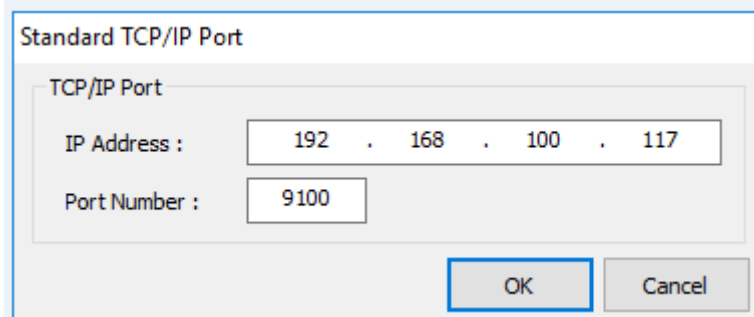

7) Click "Next".

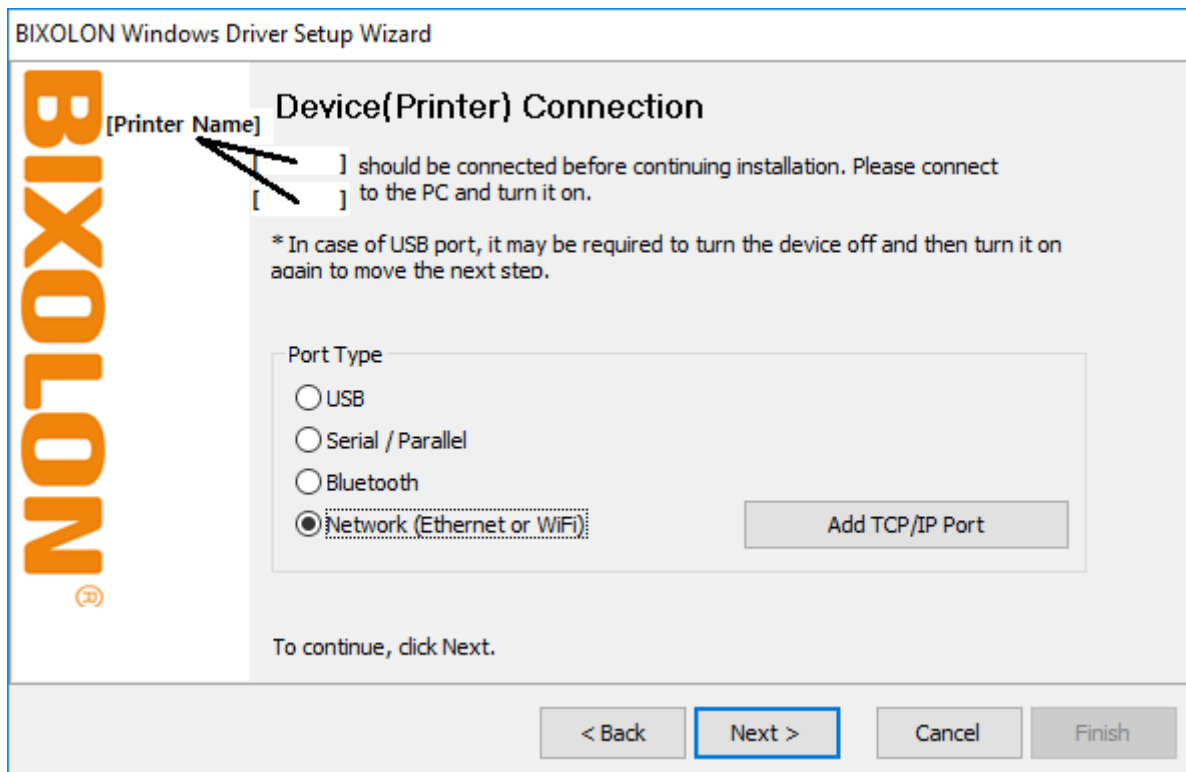

8) Click "Next".

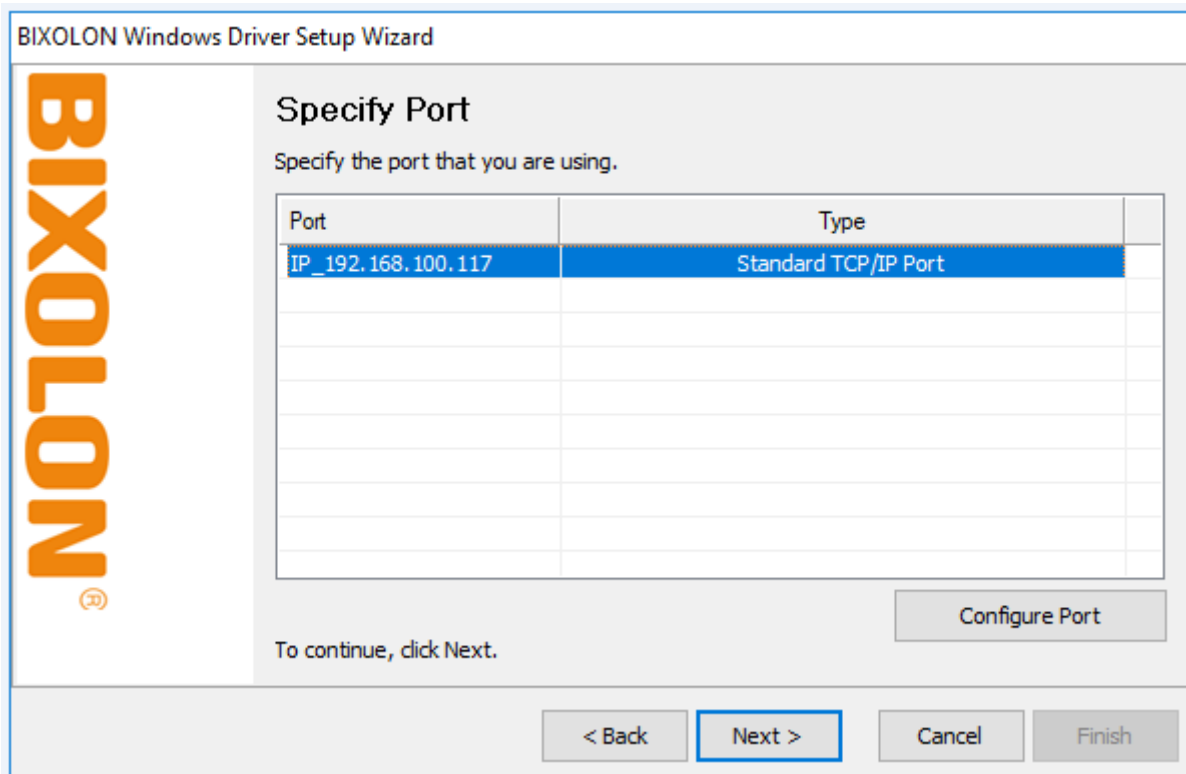

9) Click "Next".

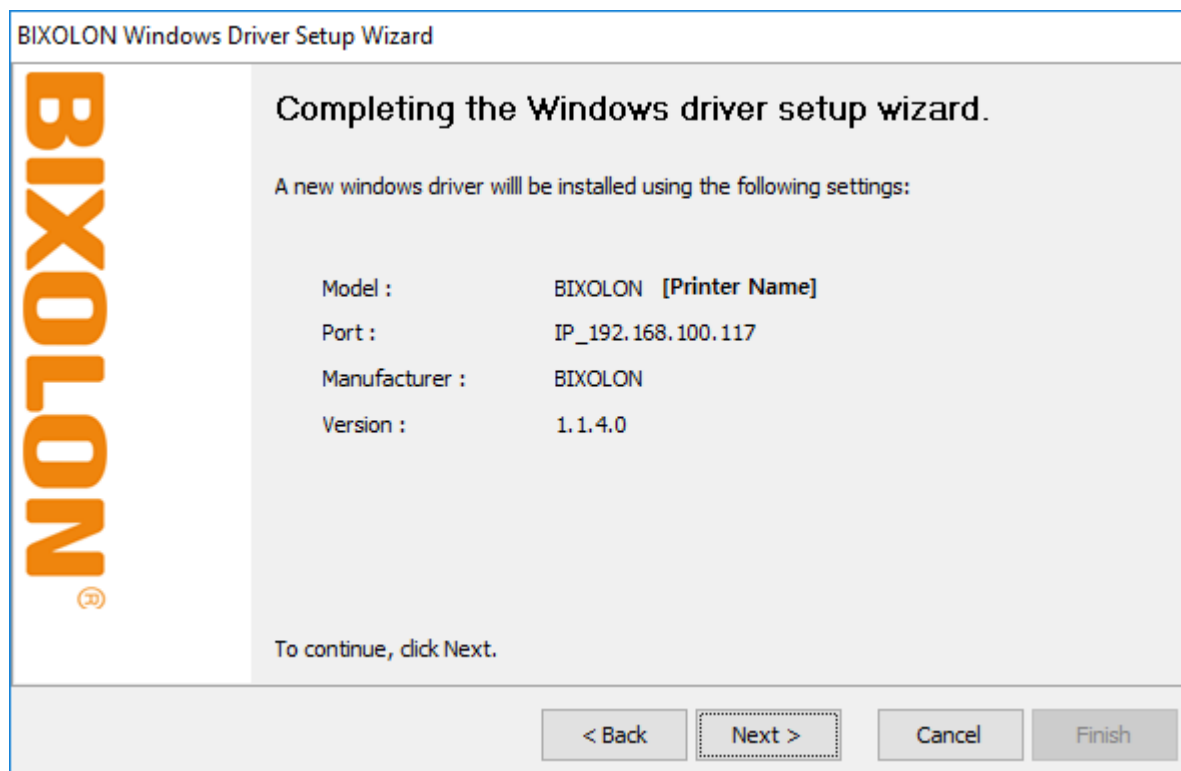

10) Click "Finish".

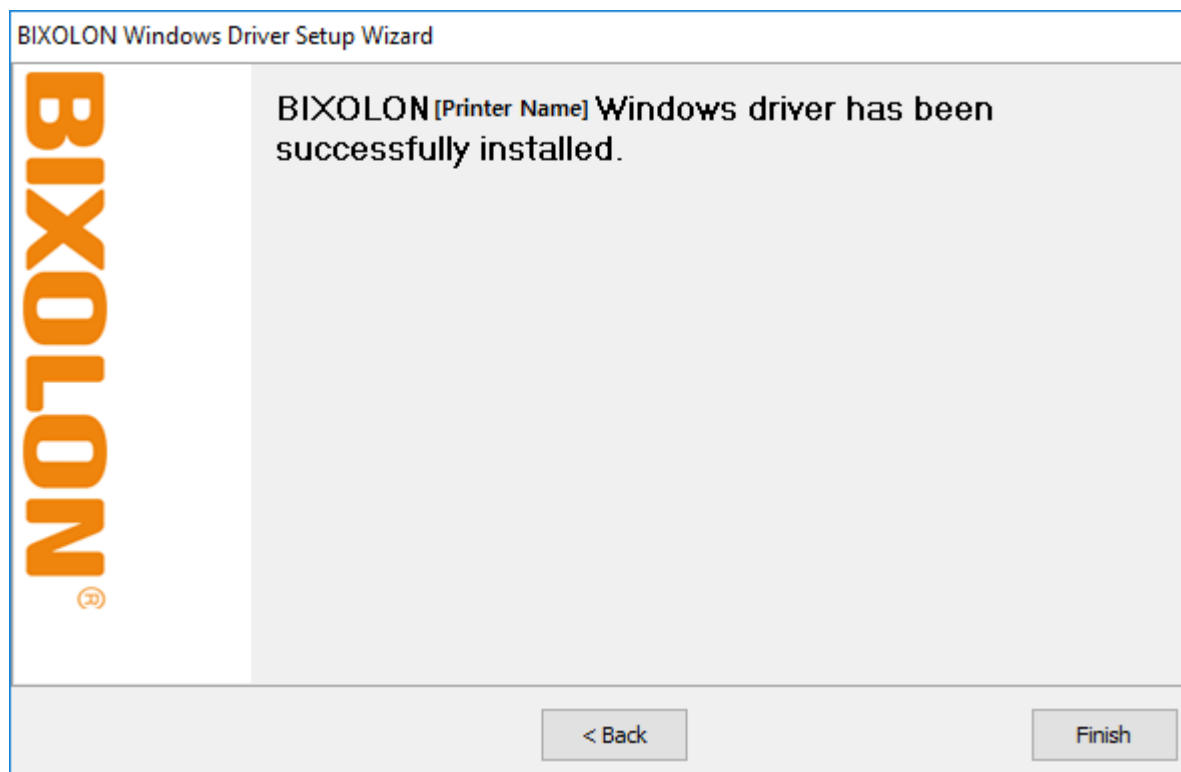

Network Connection Manual

11) Open the printer properties window in the Windows OS.

(1) Installing on Windows XP / Server 2003

※ Control Panel – Printers and Faxes.

(2) Installing on Windows VISTA / Server 2008 / 7 / 8 / Server 2012 / 10

※ Control Panel – Hardware and Sound – Device and Printers.

12) In the Ports tab, click Configure Port.

13) Match the communication settings to those of the printer.

Configure Standard TCP/IP Port Monitor

Port Settings

Port Name: IP_192.168.100.117

Printer Name or IP Address: 192.168.100.117

Protocol

Raw LPR

Raw Settings

Port Number: 9100

LPR Settings

Queue Name:

LPR Byte Counting Enabled

SNMP Status Enabled

Community Name: public

SNMP Device Index: 1

OK Cancel

Network Connection Manual

- 14) Click "Print Test Page" and check printing status. Proper installation of the driver is indicated if the test page is printed normally.

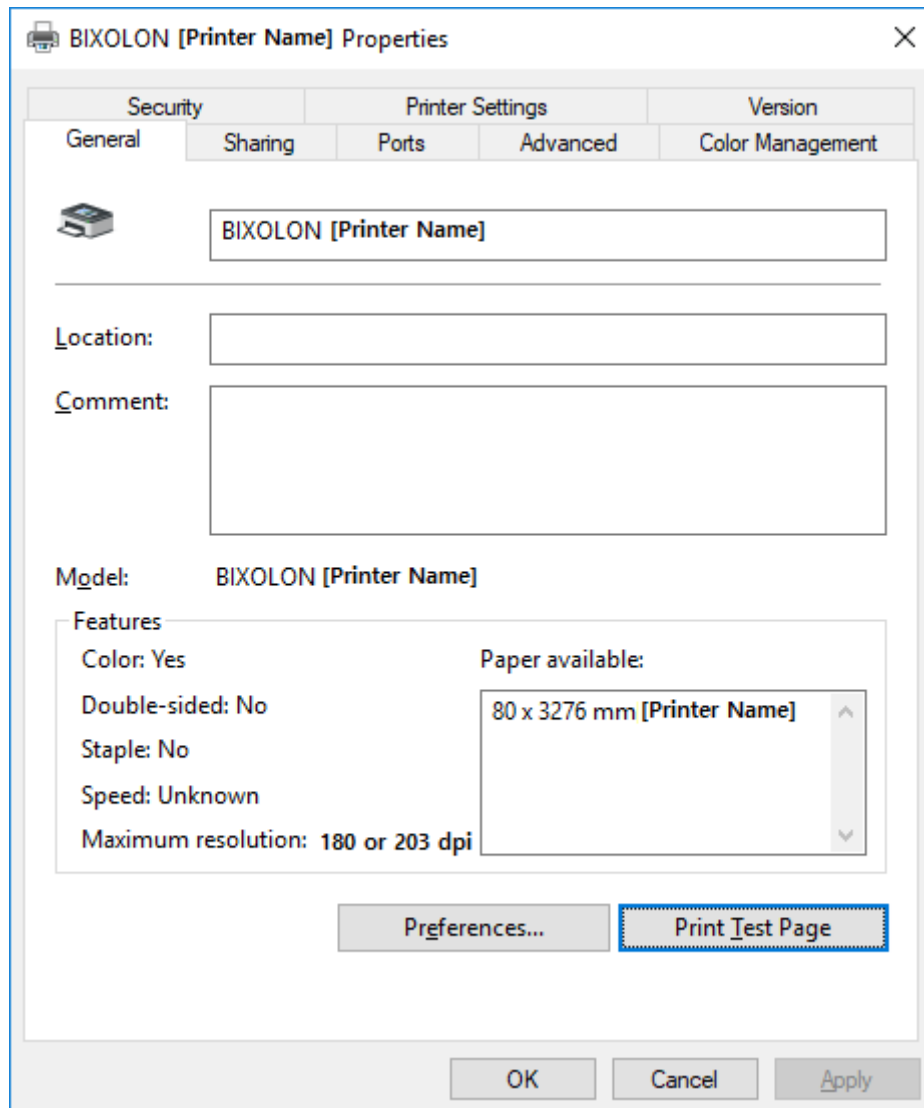

6. Factory Reset

This function changes the Network settings of the printer to the initial factory settings.

- The SSID of the WLAN is also reset to Default (Soft AP).

6-1 Initializing Ethernet Interface Setting(IFJ-E)

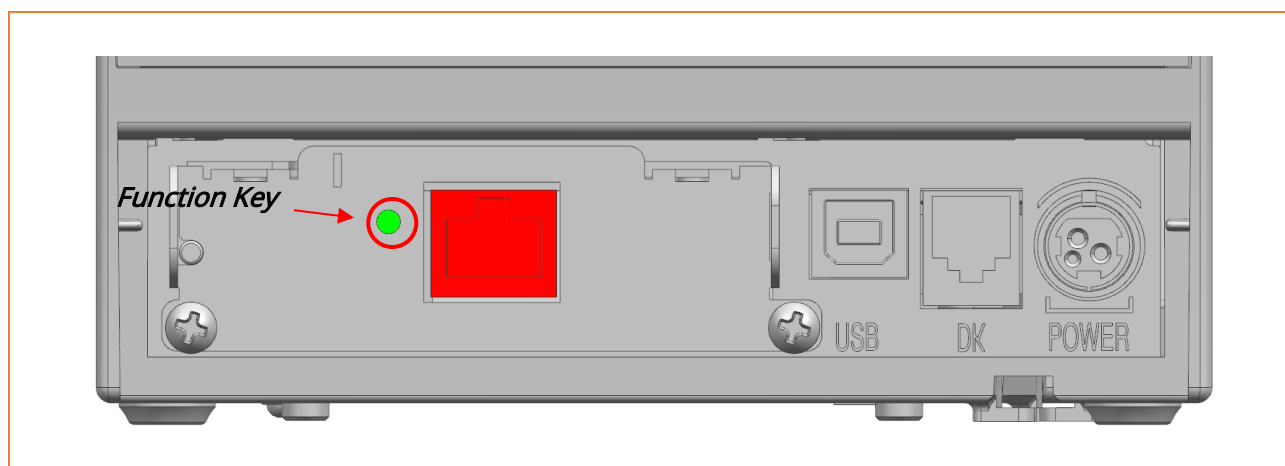

With the printer turned off, press the "Function Key" button and turn the printer on. After pressing and holding the "Function Key" button for about 5 seconds, release it. The factory reset occurs. Regardless of the current setting, DHCP mode is enabled.

[Dynamic IP network environment]

IP address is assigned to the printer and it can connect to web-server using the assigned IP address.

Newly assigned IP address can be checked with the Function key.



[Fixed IP network environment]

IP address is not automatically assigned to the printer.

Wait for 30 seconds and check whether IP address is assigned to the printer by pressing the Function key. If IP address is 0.0.0.0, it means that IP address has not been assigned. In this case, disable DHCP mode using the "Network Configuration Tool"

6-2 Initializing On-Board Ethernet / Ethernet Interface (IFJ-EL) / WLAN Setting

6-2-1 Standard model (Excluding SRP-Q300II)

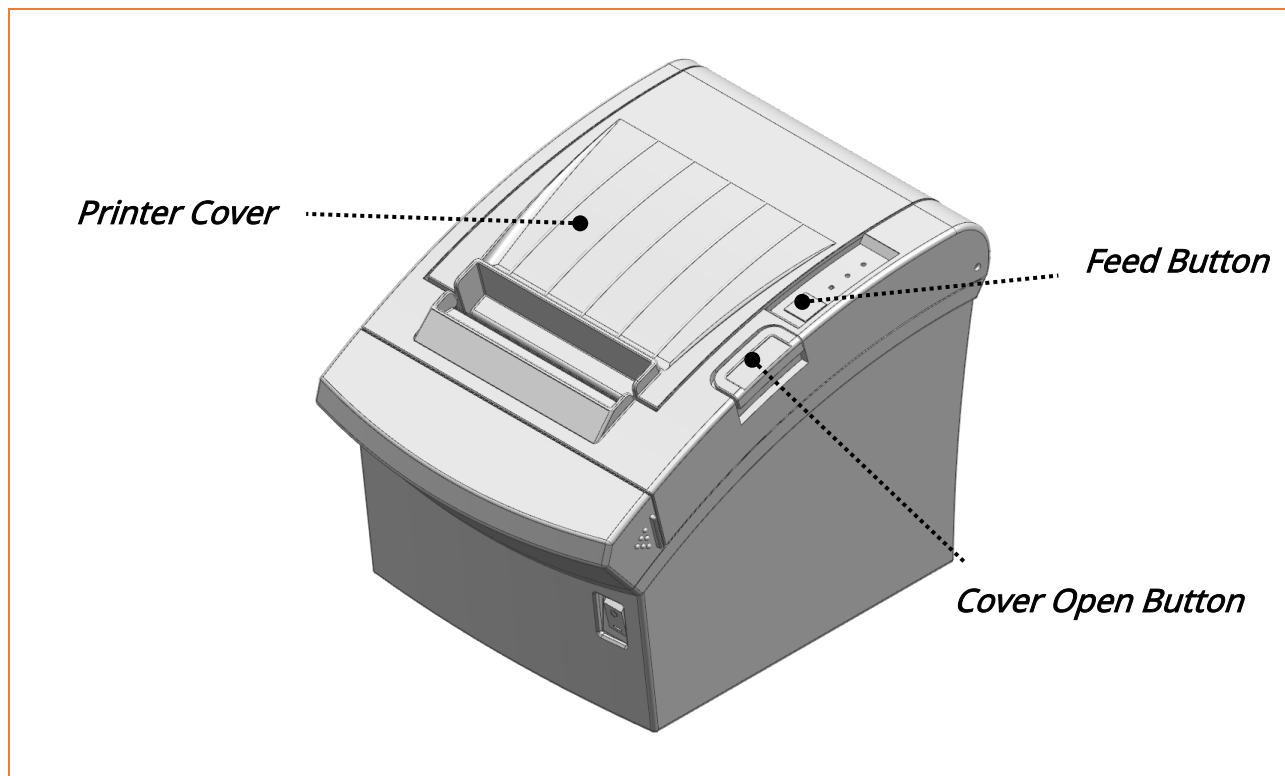

1) Open the printer cover after the printer has fully booted up.

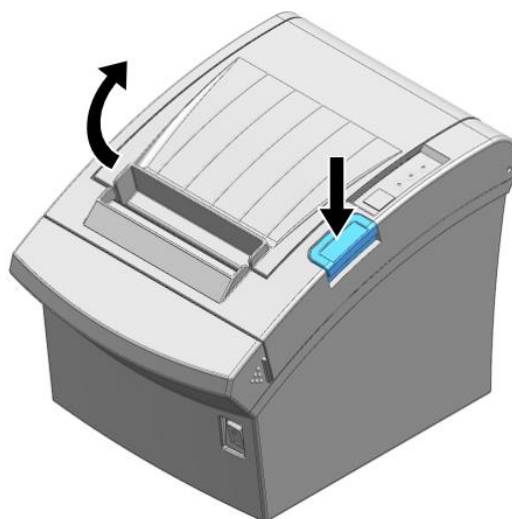

2) Press and hold the Feed button for 5 seconds.

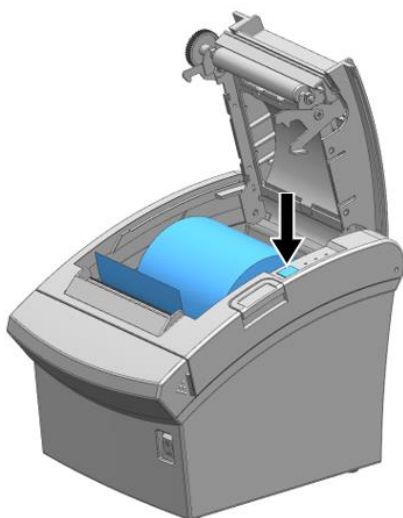

3) When you close the printer cover, the internal buzzer will beep 5 times and the printer will enter the interface setting verification mode. You will then see the following message printed out.

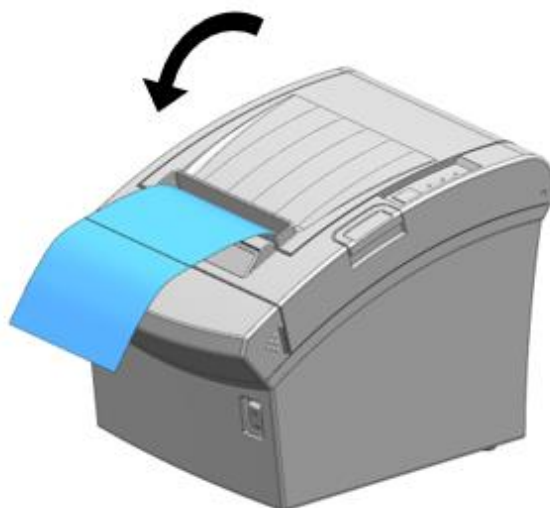

- Error/Paper LED toggles when WLAN boots up.
- The number of interface setting information may be different for each interface type of the product.

Checking Interface Setting

0: Exit
1: LAN Information Print
2: LAN Factory Reset and Reboot Printer
3: WLAN Information Print
4: WLAN Factory Reset and Reboot Printer
5 or more: None

Select Modes by Feed button control
as below.

Step 1. Short-press as many times
as the mode number to choose.

Step 2. Long-press over 1 second.

*e.g. To choose Mode 2, press Feed
button 3 times(short-short-long)

If the above message is printed, select Mode 2 / 4, and you will see the following Network information.

- To select Mode 2, press the Feed button twice quickly / once long.
- To select Mode 4, press the Feed button four times quickly / once long.

LAN(WLAN) Factory Reset OK! Reboot Printer.

After the above message is printed, the printer will automatically reboot.

6-2-2 SRP-Q300II

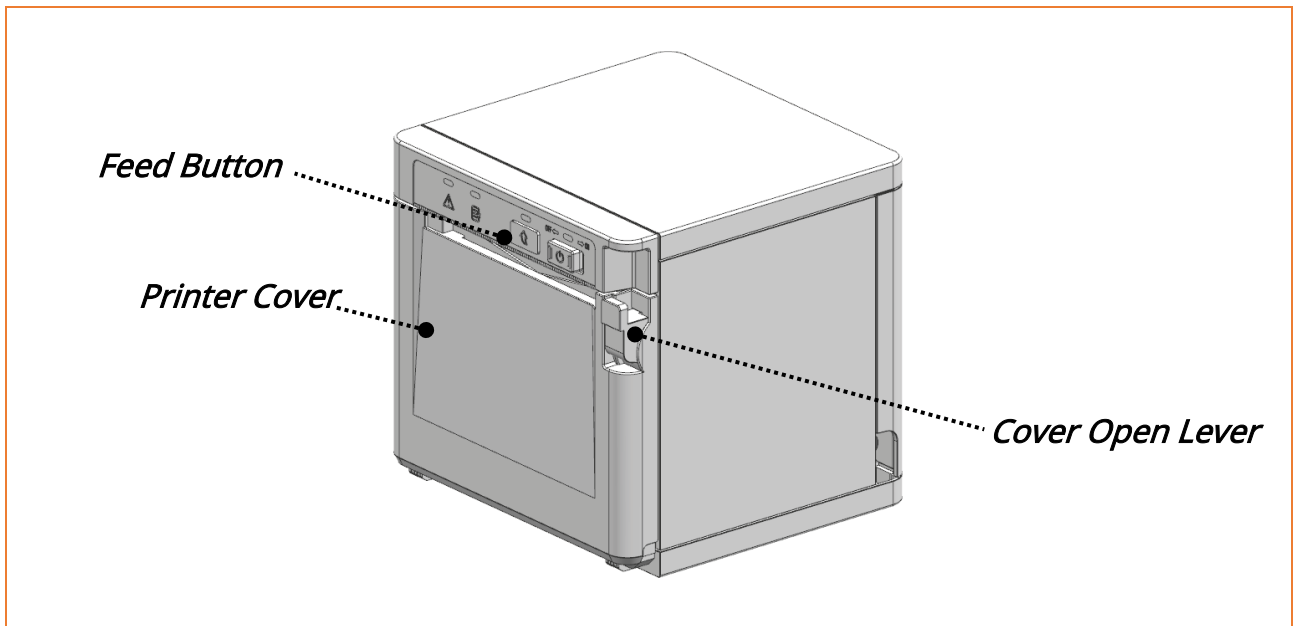

1) Open the printer cover after the printer has fully booted up.

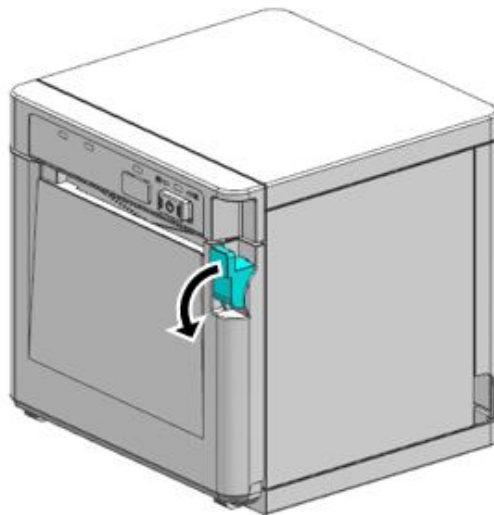

2) Press the Feed button.

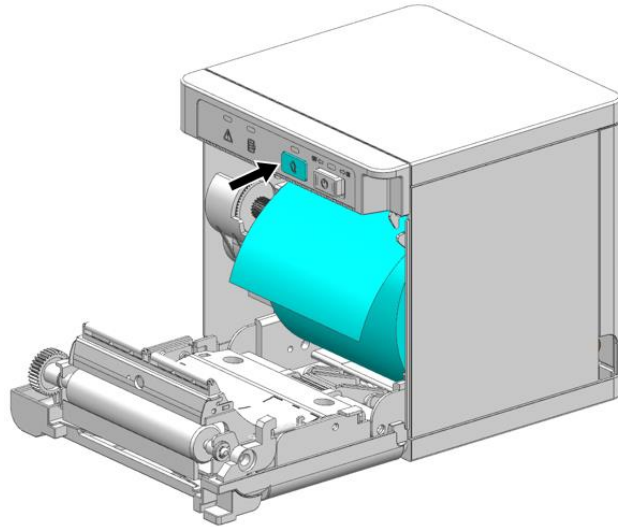

3) When you close the printer cover, the printer will enter the interface setting verification mode.

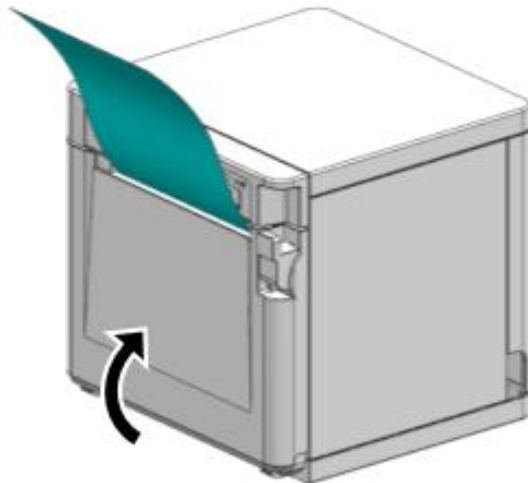

Network Connection Manual

SRP-Q300II SELF TEST INFORMATION	
Firmware Version	V0x.xx STB xxxxxx
<hr/>	
Configuration	...
	...
<hr/>	
Ethernet configuration	
<hr/>	
	...
	...
<hr/>	
WLAN configuration	
<hr/>	
	...
	...
<hr/>	
SELECT MODES BY PRESSING FEED BUTTON	
Exit SELF-TEST : Less than 1 second	
Mode Selection : 1 second or more	

Once self-test printing is complete, press and hold the button to enter "Mode Selection".

<p>Mode Selection</p> <p>0: Exit 1: VMSM Selection Mode 2: Interface Setting 3: Hexadecimal Dumping 4 or more: None</p> <p>Select Modes by Feed button control as below.</p> <p>Step 1. Short-press as many times as The mode number to choose.</p> <p>Step 2. Long-press over 1 second.</p> <p>*e.g. To choose Mode 2, press Feed Button 3 times(short-short-long)</p>
--

When the above message is displayed, select Mode No. 2 'Interface Setting'. To choose Mode No 2, press the Feed button 3 times, short-short-long. (Press the Feed button short-press twice and long-press over 1 second.)

Interface Setting

- 0: Exit
- 1: LAN Factory Reset
- 2: SWC mode
- 3: WLAN Factory Reset
- 4 or more: None

Select Modes by Feed button control as below.

Step 1. Short-press as many times as
The mode number to choose.

Step 2. Long-press over 1 second.

*e.g. To choose Mode 2, press Feed
Button 3 times(short-short-long)

When the above message is displayed, select Mode No. 1 'LAN Factory Reset' or Mode No 3 'WLAN Factory Reset'.

To choose Mode No 3, press the Feed button 4 times, short-short-short -long.
(Press the Feed button short-press three times and long-press over 1 second.)

1(2): LAN(WLAN) Factory Reset

* Do you really want to reset?

- 1. YES: Press the button 1 second or more
- 2. NO: Press the button less than 1 second

When the above message is displayed, press the Feed button over 1second to Confirm LAN or WLAN Factory Reset.

LAN(WLAN) Factory reset complete

When the above message is displayed, the printer will automatically reboot.

6-2-3 Factory Reset Values

LAN	Network	Inactivity time	0
		IP Assignment Method	DHCP (Automatic)
		Local Port	9100
WLAN	System	Printer Name	*Printer model
		Printer Port Num	9100
		User ID	admin
		User Password	password
	Enc / Auth	Encryption	None/Open
	Network	Network Mode	Soft AP mode
		SSID	PRINTER_{MAC address}
		Inactivity time	10
		IP Assignment Method	DHCP (Automatic)
		IP, Subnet, Gateway	IP : 192.168.1.1 Subnet : 255.255.255.0 Gateway : 192.168.1.2



- If the firmware version of the IFJ-EL is V01.02 or lower, the IP Assignment Method will be reset to Static.
(IP: 192.168.192.123/Subnet: 255.255.255.0/Gateway: 192.168.192.254)

7. Troubleshooting

Check network setting	
When using Ethernet	<p>[IP Address] Check whether the IP Address band of the printer and the AP(or wireless terminals) are the same. For example, when the subnet mask is 255.255.255.0(/24), make sure that the first three of four digits in IP address match.</p> <p>[Subnet Mask] Check whether the subnet mask of the printer matches with the one in AP(or wireless terminal).</p> <p>[Port] Check whether the port configured in the printer and the host(PC, PDA) are the same.</p>
When using WLAN Check the wireless network setting of the AP and the printer. (Refer to Configuration for checking/changing the printer settings)	<p>[SSID] Check whether the SSID of the printer matches with the one in AP(or wireless terminal)</p> <p>[802.11 mode] Check whether AP supports 802.11a, 802.11b or 802.11g.</p> <p>[Network Mode] Check the network mode of the printer. Network mode must be set to "Infrastructure" to connect to AP.</p> <p>[IP Address] Check whether the band of the printer and the AP(or wireless terminals) are the same. For example, when the subnet mask is 255.255.255.0(/24), make sure that the first three of four digits in IP address match.</p> <p>[Subnet Mask] Check whether the subnet mask of the printer matches the one in AP(or wireless terminal).</p>

[Port]

Check whether the port configured in the printer and the host(PC, PDA) are the same.

[Authentication/Encryption]

Check the authentication/encryption setting status.

Check whether the settings of the printer and the AP(wireless terminals) are the same.

PING Check

Checking IP collision

1. When entering IP address manually without using DHCP, you must check whether the corresponding IP address is used by other equipment. The printer may not work normally when there is a collision in the IP address.
2. When the printer is turned off, carry out the Ping Test to the printer IP.

Ping TEST

1. Turn off the printer.
2. Search “cmd” and then click “Open”.
3. Enter “ARP -d {printer IP}” and delete ARP table.
4. Enter “ping {printer IP}”.
5. ARP -d, ping {IP address}

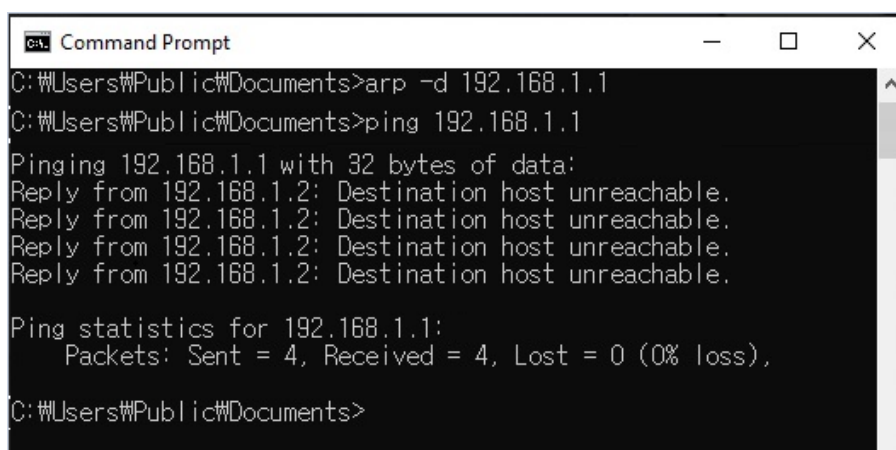

```
ca. Command Prompt
C:\Users\Public\Documents>arp -d 192.168.1.1
C:\Users\Public\Documents>ping 192.168.1.1
Pinging 192.168.1.1 with 32 bytes of data:
Reply from 192.168.1.2: Destination host unreachable.
Reply from 192.168.1.2: Destination host unreachable.
Reply from 192.168.1.2: Destination host unreachable.
Reply from 192.168.1.2: Destination host unreachable.

Ping statistics for 192.168.1.1:
    Packets: Sent = 4, Received = 4, Lost = 0 (0% loss),

C:\Users\Public\Documents>
```

When you see “Destination host unreachable.” as shown below, it means that there is no collision. The corresponding IP can be used. On the other hand, if there is a reply as shown below, then the corresponding IP is used by another network terminal and it cannot be used for the printer IP.

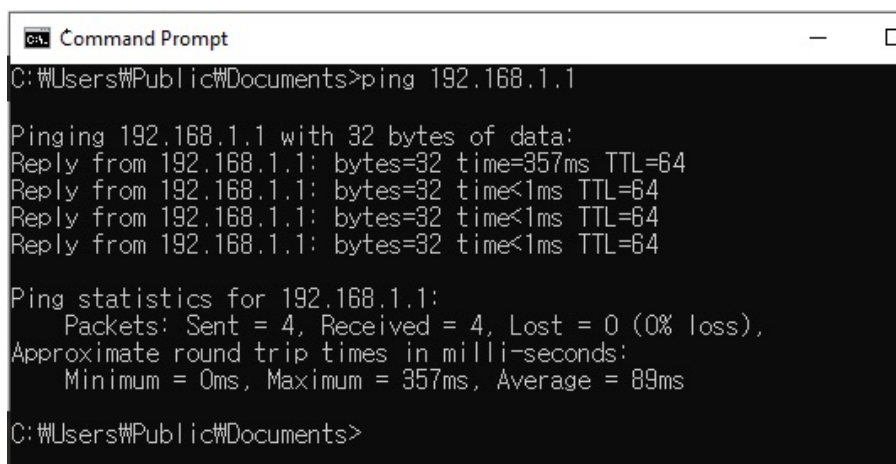

```
ca. Command Prompt
C:\Users\Public\Documents>ping 192.168.1.1
Pinging 192.168.1.1 with 32 bytes of data:
Reply from 192.168.1.1: bytes=32 time=357ms TTL=64
Reply from 192.168.1.1: bytes=32 time<1ms TTL=64
Reply from 192.168.1.1: bytes=32 time<1ms TTL=64
Reply from 192.168.1.1: bytes=32 time<1ms TTL=64

Ping statistics for 192.168.1.1:
    Packets: Sent = 4, Received = 4, Lost = 0 (0% loss),
    Approximate round trip times in milli-seconds:
        Minimum = 0ms, Maximum = 357ms, Average = 89ms

C:\Users\Public\Documents>
```

Network Connection Manual

Check Cable	
When using Ethernet	In order to check whether the problem is due to the LAN cable, connect the cable connected to the printer to other terminals or the PC to confirm whether its operation is normal.
Inactivity Time	If multiple host devices are used with one printer, "Inactivity Time" is Recommended. (Other host devices are restricted to use a printer if one host device keep connecting to a printer.) ex) 5sec

