

1. Turn the Power Switch Off at the rear of the Printer.

※ The images shown in this manual are of SLP-DX420 which has the same replacement steps as TPH.

Power Switch



2. Pull the cover levers on both sides to open the cover.

Cover Lever



3. Use your finger or tweezers to push the Hook TPH R in the direction indicated by the yellow arrow to remove the TPH.

※ Take care to avoid injury by the parts around the area.

TPH

Hook TPH R

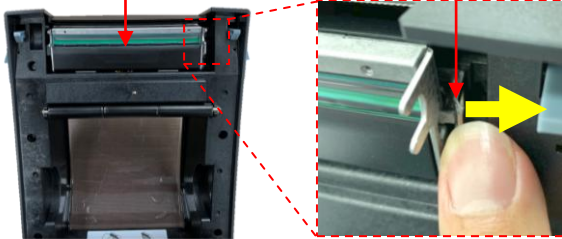

4. Remove the TPH Connector and Wire Connector on the back of TPH.

※ Take care to avoid injury as the connectors are tightly attached.

TPH

Wire Connector

TPH Connector

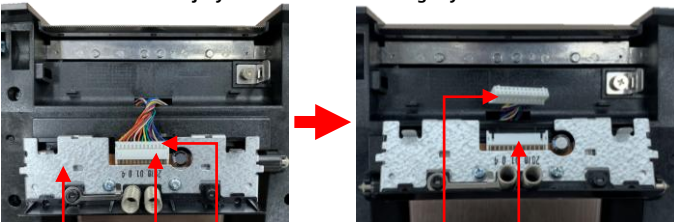

5. Assemble the TPH Connector and Wire Connector of a new TPH while ensuring they match direction.

※ Make sure that the connector is inserted all the way in.

※ If the connector is placed incorrectly, it may be damaged.

※ Avoid contact with the TPH Heating Line as it can damage the TPH.

TPH

Wire Connector

TPH Connector

※ Place it to match the

TPH Heating Line

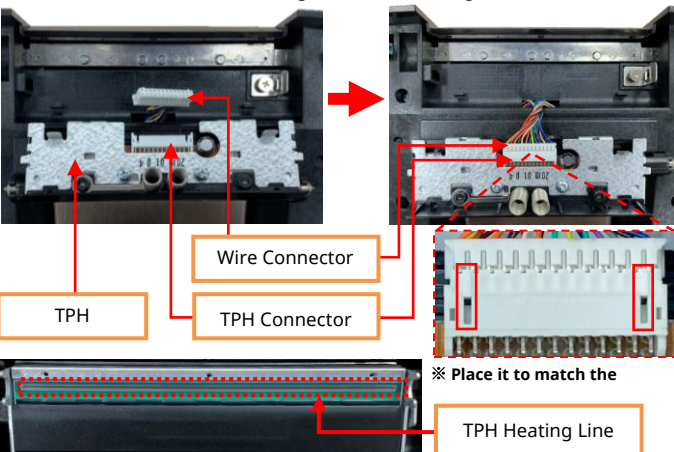

6-1. Place the left hook of the TPH on the hole and adjust it as shown in the image.

※ Avoid contact with the TPH Heating Line as it can damage the TPH.

Hook

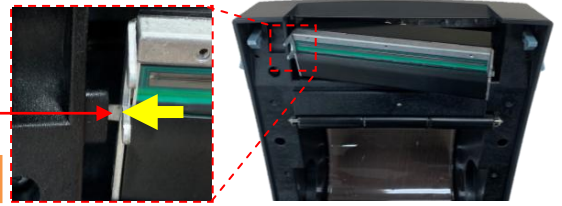

6-2. Place the 2 springs of the back against the boss and push the Cover TPH to attach the right hook to the HOOK TPH R.

※ If the hook and TPH R cannot be assembled correctly, check the attachment of the boss and springs.

※ Take care to avoid injury by the parts around the area.

※ Avoid contact with the TPH Heating Line as it can damage the TPH.

Boss

Spring

Cover TPH

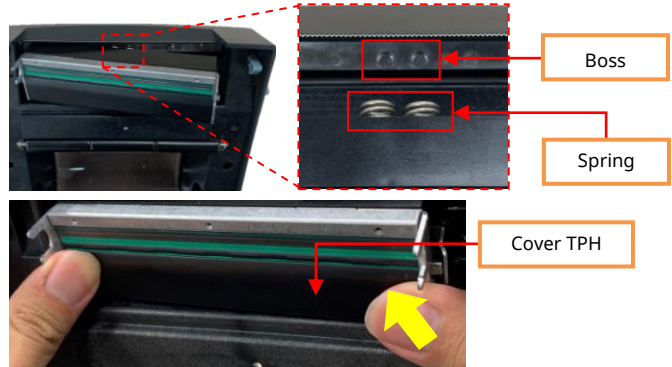

\* Use your fingers or tweezers to pull the Hook TPH R in the direction indicated by the yellow arrow if it is too hard to assemble the hook.

※ Take care to avoid injury by the parts around the area.

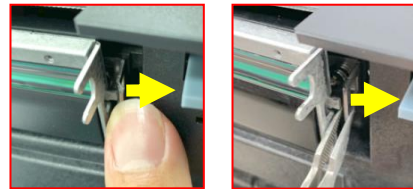

7. Push the COVER-TPH 2-3 times to make sure it is mounted correctly.

※ Check the spring's elasticity.

※ Avoid contact with the TPH Heating Line as it can damage the TPH.



8. Load the media and close the cover.

Media



9. Turn on the power switch on the back of printer and perform Self-test to check the printing quality.



Power Switch

※ Refer to the User Manual for how to load media and perform Self-test.



1. Printer 후면의 Power Switch 를 Off 하십시오.  
 ※ 본 매뉴얼 이미지는 SLP-DX420 모델이지만 TPH 의 교체방법은 동일합니다.

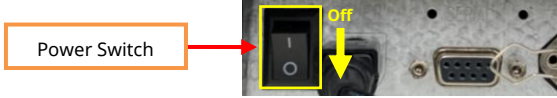

2. 양 측면의 Cover Lever 를 당겨 커버를 열어 주십시오.



3. 그림과 같이 손이나 핀셋 등을 사용하여 Hook TPH R 을 노란색 화살표 방향으로 밀어 TPH 를 분리해 주십시오.  
 ※ 작업 시 주변 부품에 의해 상해를 입지 않도록 주의하십시오.

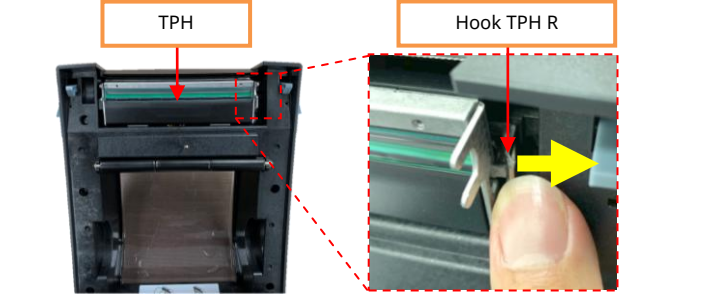

4. TPH 후면의 TPH Connector 와 Wire Connector 를 분리해 주십시오.  
 ※ Connector 의 체결 강도가 높으니, 작업 시 신체에 손상을 입지 않도록 주의하십시오.

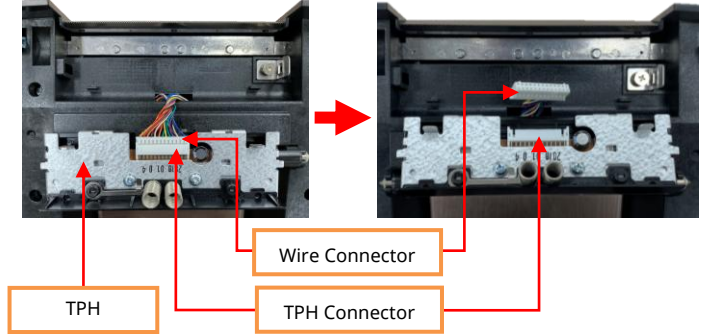

5. 준비된 신규 TPH 의 TPH Connector 와 Wire Connector 를 서로 방향에 맞게 조립해 주십시오.

- ※ Connector 가 설삼 되지 않게 주의하십시오.  
 ※ Connector 의 방향을 틀리게 삽입하면 Connector 가 파손될 수 있으니 주의하십시오.  
 ※ TPH 의 Heating Line 을 접촉하면 TPH 가 손상될 수 있으니 작업 시 주의하십시오.

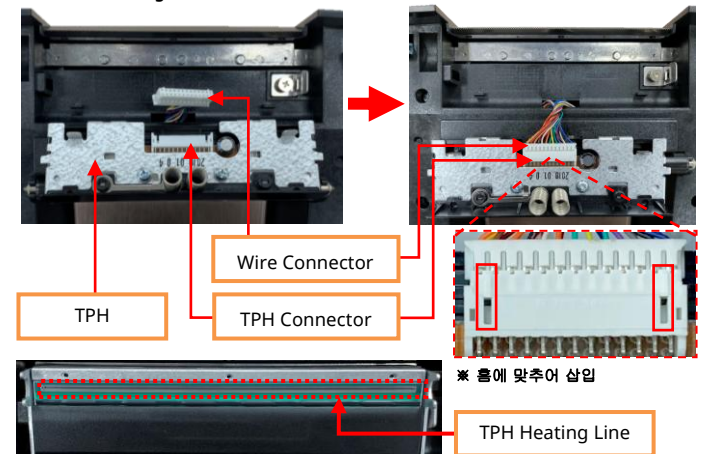

- 6-1. TPH 의 좌측 Hook 를 커버 홈에 넣고 그림과 같이 정형하십시오.  
 ※ TPH 의 Heating Line 을 접촉하면 TPH 가 손상될 수 있으니 작업 시 주의하십시오.

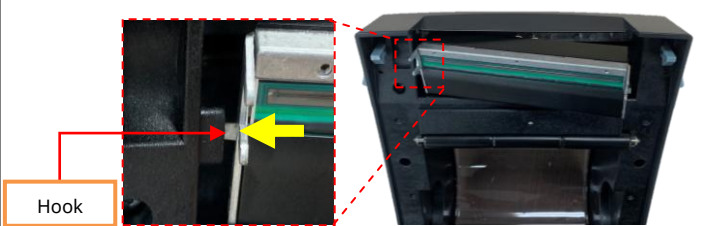

- 6-2. TPH 후면의 Spring 2 개소를 BOSS 부에 맞추고 그림과 같이 TPH 의 좌측을 받치고 Cover TPH 를 눌러 우측 Hook 를 Hook TPH R 에 조립해 주십시오.

- ※ Hook TPH R 과 조립이 잘 되지 않는다면 Boss 와 Spring 정형 상태를 확인하십시오.  
 ※ 작업 시 주변 부품에 의해 상해를 입지 않도록 주의하십시오.  
 ※ TPH 의 Heating Line 을 접촉하면 TPH 가 손상될 수 있으니 작업 시 주의하십시오.

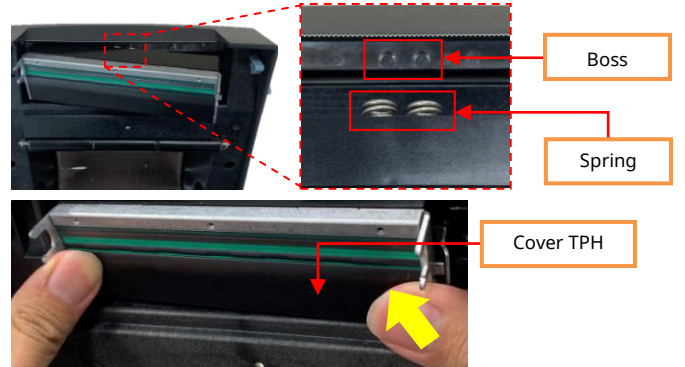

- \* Hook 조립에 어려움이 있다면, 손이나 핀셋 등을 사용하여 Hook TPH R 을 노란색 화살표 방향으로 당겨 조립해 주십시오.  
 ※ 작업 시 주변 부품에 의해 상해를 입지 않도록 주의하십시오.

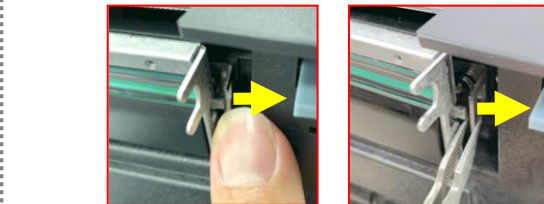

7. Cover TPH 를 2-3 회 눌러 장착이 잘 되었는지 확인해 주십시오.

- ※ 눌렀을 때, 스프링의 장력이 잘 작용하는지 확인해 주십시오.  
 ※ TPH 의 Heating Line 을 접촉하면 TPH 가 손상될 수 있으니 작업 시 주의하십시오.

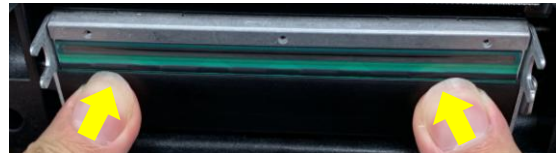

8. Media 를 장착하고 커버를 닫아 주십시오.

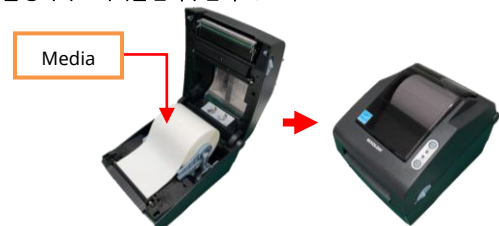

9. Printer 후면의 Power Switch 를 On 하고 Self-test 를 진행하여 인쇄 품질의 이상이 없는지 확인해 주십시오.



- ※ Media 장착 방법과 Self-test 진행 방법은 User Manual 을 참고해 주십시오.